

53-1001763-02  
13 September 2010

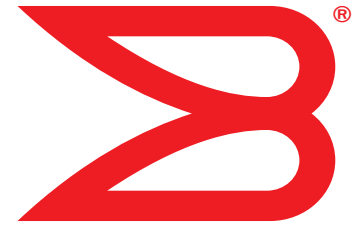

# Fabric OS

---

## Administrator's Guide

Supporting Fabric OS v6.4.0

**BROCADE**

Copyright © 2005-2010 Brocade Communications Systems, Inc. All Rights Reserved.

Brocade, the B-wing symbol, BigIron, DCX, Fabric OS, FastIron, IronPoint, IronShield, IronView, IronWare, JetCore, NetIron, SecureIron, ServerIron, StorageX, and Turbolron are registered trademarks, and DCFM, Extraordinary Networks, and SAN Health are trademarks of Brocade Communications Systems, Inc., in the United States and/or in other countries. All other brands, products, or service names are or may be trademarks or service marks of, and are used to identify, products or services of their respective owners.

Notice: This document is for informational purposes only and does not set forth any warranty, expressed or implied, concerning any equipment, equipment feature, or service offered or to be offered by Brocade. Brocade reserves the right to make changes to this document at any time, without notice, and assumes no responsibility for its use. This informational document describes features that may not be currently available. Contact a Brocade sales office for information on feature and product availability. Export of technical data contained in this document may require an export license from the United States government.

The authors and Brocade Communications Systems, Inc. shall have no liability or responsibility to any person or entity with respect to any loss, cost, liability, or damages arising from the information contained in this book or the computer programs that accompany it.

The product described by this document may contain "open source" software covered by the GNU General Public License or other open source license agreements. To find out which open source software is included in Brocade products, view the licensing terms applicable to the open source software, and obtain a copy of the programming source code, please visit <http://www.brocade.com/support/oscd>.

## Brocade Communications Systems, Incorporated

Corporate and Latin American Headquarters  
Brocade Communications Systems, Inc.  
130 Holger Way  
San Jose, CA 95134  
Tel: 1-408-333-8000  
Fax: 1-408-333-8101  
E-mail: [info@brocade.com](mailto:info@brocade.com)

Asia-Pacific Headquarters  
Brocade Communications Systems China HK, Ltd.  
No. 1 Guanghua Road  
Chao Yang District  
Units 2718 and 2818  
Beijing 100020, China  
Tel: +8610 6588 8888  
Fax: +8610 6588 9999  
E-mail: [china-info@brocade.com](mailto:china-info@brocade.com)

European Headquarters  
Brocade Communications Switzerland Sàrl  
Centre Swissair  
Tour B - 4ème étage  
29, Route de l'Aéroport  
Case Postale 105  
CH-1215 Genève 15  
Switzerland  
Tel: +41 22 799 5640  
Fax: +41 22 799 5641  
E-mail: [emea-info@brocade.com](mailto:emea-info@brocade.com)

Asia-Pacific Headquarters  
Brocade Communications Systems Co., Ltd. (Shenzhen WFOE)  
Citic Plaza  
No. 233 Tian He Road North  
Unit 1308 - 13th Floor  
Guangzhou, China  
Tel: +8620 3891 2000  
Fax: +8620 3891 2111  
E-mail: [china-info@brocade.com](mailto:china-info@brocade.com)

## Document History

Title	Publication number	Summary of changes	Date
<i>Fabric OS Procedures Guide</i>	53-0000518-02	First released edition.	April 2003
<i>Fabric OS Procedures Guide</i>	53-0000518-03	Revised for Fabric OS v4.2.0.	December 2003
<i>Fabric OS Procedures Guide</i>	53-0000518-04	Revised to include switch-specific information.	March 2004
<i>Fabric OS Procedures Guide</i>	53-0000518-05	Revised for Fabric OS v4.4.0.	September 2004
<i>Fabric OS Procedures Guide</i>	53-0000518-06	Revised to add RADIUS and SSL procedures.	October 2004
<i>Fabric OS Administrator's Guide</i>	53-0000518-07	Revised book title. Added information about 200E, 4012, and 48000 switches.	April 2005
<i>Fabric OS Administrator's Guide</i>	53-1000043-01	Revised for Fabric OS v5.1.0.	January 2006

<b>Title</b>	<b>Publication number</b>	<b>Summary of changes</b>	<b>Date</b>
<i>Fabric OS Administrator's Guide</i>	53-1000043-02	Removed SilkWorm 4016 and 4020 from supported switches; FCIP chapter updates.	June 2006
<i>Fabric OS Administrator's Guide</i>	53-1000239-01	Revised for Fabric OS v5.2.0 features. Added new hardware platforms: Brocade FC4-48 and FC4-16IP.	September 2006
<i>Fabric OS Administrator's Guide</i>	53-1000448-01	Added Fabric OS v5.3.0 features. Added support for new hardware platforms: Brocade 7600, FA4-18, and FC10-6.	15 June 2007
<i>Fabric OS Administrator's Guide</i>	53-1000598-01	Added Fabric OS v6.0.0 features. Added support for new hardware platforms: Brocade DCX Backbone, FC8-16, FC8-32, and FC8-48.	19 October 2007
<i>Fabric OS Administrator's Guide</i>	53-1000598-02	Changed "DCX" and "DCX director" to the correct name: Brocade DCX Backbone. Also, added the word "director" to the 48000.	22 January 2008
<i>Fabric OS Administrator's Guide</i>	53-1000598-03	Added Fabric OS v6.1.0 features. Added support for new hardware platforms: Brocade 5300, 5100, and 300.	12 March 2008
<i>Fabric OS Administrator's Guide</i>	53-1000598-04	Updated document to streamline content. No new hardware or Fabric OS features.	18 July 2008
<i>Fabric OS Administrator's Guide</i>	53-1001185-01	Added Fabric OS v 6.2.0 software features and support for new hardware platforms: Brocade DCX-4S.	24 November 2008
<i>Fabric OS Administrator's Guide</i>	53-1001336-01	Added Fabric OS v6.3.0 software features and support for new hardware platforms.	July 2009
<i>Fabric OS Administrator's Guide</i>	53-1001336-02	Incorporate release notes from Fabric OS v6.3.0 and v6.3.0a.	November 2009
<i>Fabric OS Administrator's Guide</i>	53-1001763-01	Added enhancements and new features for Fabric OS v6.4.0. Added support for the Brocade VA-40FC hardware.	March 2010
<i>Fabric OS Administrator's Guide</i>	53-1001763-02	Corrected minor errors. Added additional clarification in some places.	September 2010



# Contents

---

## About This Document

In this chapter .....	xxxiii
How this document is organized .....	xxxiii
Supported hardware and software .....	xxxiv
What's new in this document .....	xxxv
Document conventions .....	xxxv
Notice to the reader .....	xxxvii
Additional information .....	xxxvii
Getting technical help .....	xxxviii
Document feedback .....	xxxix

## Section I

## Standard Features

### Chapter 1

#### Understanding Fibre Channel Services

In this chapter .....	3
Fibre Channel services overview .....	3
The Management Server .....	4
Platform services .....	4
Platform services in a Virtual Fabric .....	5
Enabling platform services .....	5
Disabling platform services .....	5
Management server database .....	5
Displaying the management server ACL .....	6
Adding a member to the ACL .....	6
Deleting a member from the ACL .....	7
Viewing the contents of the management server database .....	8
Clearing the management server database .....	8
Topology discovery .....	9
Displaying topology discovery status .....	9
Enabling topology discovery .....	9
Disabling topology discovery .....	9

Device login . . . . .	10
Principal switch . . . . .	10
E_Port login . . . . .	10
Fabric login . . . . .	11
Port login process . . . . .	11
RSCN causes . . . . .	12
High availability of daemon processes . . . . .	12

## Chapter 2

### Performing Basic Configuration Tasks

In this chapter . . . . .	15
Fabric OS overview . . . . .	15
Fabric OS command line interface . . . . .	16
Console sessions using the serial port . . . . .	16
Telnet or SSH sessions . . . . .	17
Getting help on a command . . . . .	18
Password modification . . . . .	18
Default account passwords . . . . .	19
The Ethernet interface on your switch . . . . .	20
Virtual Fabrics and the Ethernet interface . . . . .	20
Displaying the network interface settings . . . . .	21
Static Ethernet addresses . . . . .	22
DHCP activation . . . . .	23
IPv6 autoconfiguration . . . . .	24
Date and time settings . . . . .	25
Setting the date and time . . . . .	25
Time zone settings . . . . .	26
Network time protocol . . . . .	27
Domain IDs . . . . .	28
Displaying the domain IDs . . . . .	29
Setting the domain ID . . . . .	30
Switch names . . . . .	30
Customizing the switch name . . . . .	30
Chassis names . . . . .	31
Customizing chassis names . . . . .	31
Switch activation and deactivation . . . . .	31
Disabling a switch . . . . .	31
Enabling a switch . . . . .	31
Switch and enterprise-class platform shutdown . . . . .	31
Powering off a Brocade switch . . . . .	32
Powering off a Brocade enterprise-class platform . . . . .	32
Basic connections . . . . .	33
Device connection . . . . .	33
Switch connection . . . . .	33

## Chapter 3

## Performing Advanced Configuration Tasks

In this chapter . . . . .	35
PIDs and PID binding overview . . . . .	35
Core PID addressing mode . . . . .	36
Fixed addressing mode . . . . .	36
10-bit addressing mode . . . . .	36
256-area addressing mode . . . . .	37
WWN-based PID assignment . . . . .	37
Ports . . . . .	39
Setting port names . . . . .	41
Port identification by slot and port number . . . . .	41
Port identification by port area ID . . . . .	41
Port identification by index . . . . .	41
Swapping port area IDs . . . . .	42
Port activation and deactivation . . . . .	42
Setting port speeds . . . . .	43
Setting the same speed for all ports on the switch . . . . .	44
Blade terminology and compatibility . . . . .	44
CP blades . . . . .	46
Core blades . . . . .	46
Port and application blade compatibility . . . . .	46
FX8-24 compatibility notes . . . . .	48
Enabling and disabling blades . . . . .	48
Enabling blades . . . . .	48
Disabling blades . . . . .	50
Blade swapping . . . . .	50
Swapping blades . . . . .	51
Swapping blades . . . . .	52
Power management . . . . .	53
Powering off a port blade . . . . .	53
Powering on a port blade . . . . .	53
Equipment status . . . . .	54
Checking switch operation . . . . .	54
Verifying High Availability features (directors and enterprise-class platforms only) . . . . .	54
Verifying fabric connectivity . . . . .	55
Verifying device connectivity . . . . .	55
Track and control switch changes . . . . .	56
Enabling the track changes feature . . . . .	56
Displaying the status of the track changes feature . . . . .	57
Viewing the switch status policy threshold values . . . . .	57
Setting the switch status policy threshold values . . . . .	57
Audit log configuration . . . . .	59
Auditable event classes . . . . .	60
Verifying host syslog prior to configuring the audit log . . . . .	60
Configuring an audit log for specific event classes . . . . .	61

## Chapter 4

### Routing Traffic

About this chapter . . . . .	63
Routing overview . . . . .	63
Path versus route selection . . . . .	64
FSPF . . . . .	64
Fibre Channel NAT . . . . .	65
Inter-switch links . . . . .	66
Buffer credits . . . . .	67
Virtual Channels . . . . .	67
Gateway links . . . . .	69
Configuring a link through a gateway . . . . .	70
Inter-chassis links . . . . .	71
Supported topologies . . . . .	72
Routing policies . . . . .	73
Displaying the current routing policy . . . . .	74
Exchange-based routing . . . . .	74
Port-based routing . . . . .	74
AP route policy . . . . .	75
Routing in Virtual Fabrics . . . . .	75
Route selection . . . . .	76
Dynamic Load Sharing . . . . .	76
Static route assignment . . . . .	77
Frame order delivery . . . . .	78
Forcing in-order frame delivery across topology changes . . . . .	78
Restoring out-of-order frame delivery across topology changes . . . . .	78
Lossless Dynamic Load Sharing on ports . . . . .	79
Lossless core . . . . .	80
Configuring Lossless Dynamic Load Sharing . . . . .	80
Lossless Dynamic Load Sharing in Virtual Fabrics . . . . .	80
Frame Redirection . . . . .	81
Creating a frame redirect zone . . . . .	82
Deleting a frame redirect zone . . . . .	82
Viewing redirect zones . . . . .	82

## Chapter 5

### Managing User Accounts

In this chapter . . . . .	83
User accounts overview . . . . .	83
Role-Based Access Control (RBAC) . . . . .	84
The management channel . . . . .	87
Local database user accounts . . . . .	88
Default accounts . . . . .	88
Local account passwords . . . . .	89
Local account database distribution . . . . .	90
Distributing the local user database . . . . .	90
Accepting distribution of user databases on the local switch . . . . .	90
Rejecting distributed user databases on the local switch . . . . .	90



Password policies . . . . .	91
Password strength policy . . . . .	91
Password history policy . . . . .	92
Password expiration policy . . . . .	93
Account lockout policy . . . . .	93
The boot PROM password . . . . .	95
Setting the boot PROM password for a switch with a recovery string 95	
Setting the boot PROM password for a director with a recovery string 96	
Setting the boot PROM password for a switch without a recovery string . . . . .	97
Setting the boot PROM password for a director without a recovery string . . . . .	98
The authentication model using RADIUS and LDAP . . . . .	99
Setting the switch authentication mode . . . . .	101
Fabric OS user accounts . . . . .	101
Fabric OS users on the RADIUS server . . . . .	102
The RADIUS server . . . . .	105
LDAP configuration and Microsoft Active Directory . . . . .	111
Authentication servers on the switch . . . . .	114
Configuring local authentication as backup . . . . .	115

## Chapter 6

### Configuring Protocols

In this chapter . . . . .	117
Security protocols . . . . .	117
Secure Copy . . . . .	118
Setting up SCP for configUploads and downloads . . . . .	119
Secure Shell protocol . . . . .	119
SSH public key authentication . . . . .	120
Secure Sockets Layer protocol . . . . .	122
Browser and Java support . . . . .	122
SSL configuration overview . . . . .	123
Certificate authorities . . . . .	123
The browser . . . . .	125
Root certificates for the Java Plug-in . . . . .	126
Simple Network Management Protocol . . . . .	127
SNMP and Virtual Fabrics . . . . .	128
The security level . . . . .	129
The snmpConfig command . . . . .	129
Telnet protocol . . . . .	129
Blocking Telnet . . . . .	129
Unblocking Telnet . . . . .	130
Listener applications . . . . .	131
Ports and applications used by switches . . . . .	131
Port configuration . . . . .	132

## Chapter 7

## Configuring Security Policies

In this chapter . . . . .	133
ACL policies overview . . . . .	133
How the ACL policies are stored . . . . .	133
Policy members . . . . .	134
ACL policy management . . . . .	134
Displaying ACL policies . . . . .	135
Saving changes without activating the policies . . . . .	135
Activating policy changes . . . . .	135
Deleting an ACL policy . . . . .	135
Adding a member to an existing ACL policy . . . . .	136
Removing a member from an ACL policy . . . . .	136
Aborting unsaved policy changes . . . . .	136
FCS policies . . . . .	137
FCS policy restrictions . . . . .	137
Ensuring fabric domains share policies . . . . .	138
Creating an FCS policy . . . . .	138
Modifying the order of FCS switches . . . . .	139
FCS policy distribution . . . . .	139
DCC policies . . . . .	140
DCC policy restrictions . . . . .	141
Creating a DCC policy . . . . .	141
Deleting a DCC policy . . . . .	142
SCC policies . . . . .	143
Creating an SCC policy . . . . .	143
Authentication policy for fabric elements . . . . .	144
E_Port authentication . . . . .	145
Device authentication policy . . . . .	147
AUTH policy restrictions . . . . .	147
Authentication protocols . . . . .	148
Secret key pairs for DH-CHAP . . . . .	149
FCAP configuration overview . . . . .	150
Fabric-wide distribution of the Auth policy . . . . .	153
IP Filter policy . . . . .	153
Creating an IP Filter policy . . . . .	153
Cloning an IP Filter policy . . . . .	154
Displaying an IP Filter policy . . . . .	154
Saving an IP Filter policy . . . . .	154
Activating an IP Filter policy . . . . .	154
Deleting an IP Filter policy . . . . .	155
IP Filter policy rules . . . . .	155
IP Filter policy enforcement . . . . .	157
Adding a rule to an IP Filter policy . . . . .	157
Deleting a rule to an IP Filter policy . . . . .	157
Aborting an IP Filter transaction . . . . .	157
IP Filter policy distribution . . . . .	158

Policy database distribution . . . . .	158
Database distribution settings . . . . .	159
ACL policy distribution to other switches . . . . .	160
Fabric-wide enforcement . . . . .	160
Notes on joining a switch to the fabric . . . . .	162
Management interface security . . . . .	164
Configuration examples . . . . .	165
IPsec protocols . . . . .	166
Security associations . . . . .	167
Authentication and encryption algorithms . . . . .	167
IPsec policies . . . . .	168
IKE policies . . . . .	169
Creating the tunnel . . . . .	170
Example of an End-to-End Transport Tunnel mode . . . . .	172

**Chapter 8                    Maintaining the Switch Configuration File**

In this chapter . . . . .	175
Configuration settings . . . . .	175
Configuration file format . . . . .	176
Configuration file backup . . . . .	178
Uploading a configuration file in interactive mode . . . . .	179
Configuration file restoration . . . . .	180
Restrictions . . . . .	180
Configuration download without disabling a switch . . . . .	182
Configurations across a fabric . . . . .	184
Downloading a configuration file from one switch to another same model switch . . . . .	184
Security considerations . . . . .	184
Configuration management for Virtual Fabrics . . . . .	184
Uploading a configuration file from a switch with Virtual Fabrics enabled . . . . .	185
Restoring logical switch configuration using configDownload Restrictions . . . . .	185
Restrictions . . . . .	186
Brocade configuration form . . . . .	187

**Chapter 9                    Installing and Maintaining Firmware**

In this chapter . . . . .	189
Firmware download process overview . . . . .	189
Upgrading and downgrading firmware . . . . .	190
Considerations for FICON CUP environments . . . . .	191
HA sync state . . . . .	191
Preparing for a firmware download . . . . .	192
Connected switches . . . . .	192
Finding the switch firmware version . . . . .	193
Obtain and decompress firmware . . . . .	193

Firmware download on switches . . . . .	193
Switch firmware download process overview. . . . .	194
Firmware download on an enterprise-class platform . . . . .	196
Enterprise-class platform firmware download process overview	196
Firmware download from a USB device. . . . .	200
Enabling USB . . . . .	200
Viewing the USB file system . . . . .	200
Downloading from USB using the relative path. . . . .	200
Downloading from USB using the absolute path. . . . .	200
FIPS Support . . . . .	201
Public and Private Key Management . . . . .	201
The firmwareDownload Command . . . . .	201
Power-on Firmware Checksum Test . . . . .	202
Test and restore firmware on switches . . . . .	203
Testing a different firmware version on a switch. . . . .	203
Test and restore firmware on enterprise-class platforms. . . . .	204
Testing different firmware versions on enterprise-class platforms	205
Validating a firmware download. . . . .	207

## Chapter 10

### Managing Virtual Fabrics

In this chapter . . . . .	209
Virtual Fabrics overview . . . . .	209
Logical switch overview . . . . .	210
Default logical switch. . . . .	210
Logical switches and fabric IDs. . . . .	212
Port assignment in logical switches . . . . .	212
Logical switches and connected devices. . . . .	213
Logical fabric overview . . . . .	214
Logical fabric and ISLs. . . . .	215
Logical fabric and ISL sharing. . . . .	216
Management model for logical switches. . . . .	219
Account management and Virtual Fabrics . . . . .	220
Supported platforms for Virtual Fabrics . . . . .	220
Supported port configurations in the Brocade 5100, 5300, and VA-40FC . . . . .	220
Supported port configurations in the Brocade DCX and DCX-4S221	221
Virtual Fabrics interaction with other Fabric OS features . . . . .	221
Limitations and restrictions of Virtual Fabrics . . . . .	222
Restrictions on moving ports . . . . .	223
Enabling Virtual Fabrics mode . . . . .	223
Disabling Virtual Fabrics mode . . . . .	224
Configuring logical switches to use basic configuration values. . . . .	225
Creating a logical switch or base switch . . . . .	225
Executing a command in a different logical fabric context . . . . .	227

Deleting a logical switch . . . . .	228
Adding and removing ports on a logical switch. . . . .	229
Displaying logical switch configuration . . . . .	230
Changing the fabric ID of a logical switch . . . . .	230
Changing a logical switch to a base switch . . . . .	231
Setting up IP addresses for a Virtual Fabric . . . . .	232
Removing an IP address for a Virtual Fabric . . . . .	232
Configuring a logical switch to use XISLs . . . . .	232
Changing the context to a different logical fabric . . . . .	233
Creating a logical fabric using XISLs . . . . .	234

## **Chapter 11 Administering Advanced Zoning**

In this chapter . . . . .	237
Special zones . . . . .	237
Zoning overview. . . . .	238
Zone types . . . . .	239
Zone objects. . . . .	240
Zone aliases. . . . .	241
Zone configurations. . . . .	242
Zoning enforcement. . . . .	242
Considerations for zoning architecture . . . . .	243
Best practices for zoning. . . . .	244
Broadcast zones . . . . .	244
Broadcast zones and Admin Domains . . . . .	244
Broadcast zones and FC-FC routing . . . . .	245
High availability considerations with broadcast zones . . . . .	246
Loop devices and broadcast zones . . . . .	246
Broadcast zones and default zoning . . . . .	246
Zone aliases . . . . .	246
Creating an alias . . . . .	246
Adding members to an alias . . . . .	247
Removing members from an alias . . . . .	247
Deleting an alias . . . . .	248
Viewing an alias in the defined configuration . . . . .	248
Zone creation and maintenance . . . . .	249
Creating a zone . . . . .	249
Adding devices (members) to a zone . . . . .	249
Removing devices (members) from a zone . . . . .	250
Deleting a zone . . . . .	250
Viewing a zone in the defined configuration . . . . .	251
Validating a zone . . . . .	251
Default zoning mode . . . . .	252
Setting the default zoning mode. . . . .	252
Viewing the current default zone access mode. . . . .	253
Zoning database size . . . . .	253

Zoning configurations . . . . .	253
Creating a zoning configuration . . . . .	254
Adding zones (members) to a zoning configuration . . . . .	254
Removing zones (members) from a zone configuration . . . . .	255
Enabling a zone configuration . . . . .	255
Disabling a zone configuration . . . . .	256
Deleting a zone configuration . . . . .	256
Clearing changes to a configuration. . . . .	257
Viewing all zone configuration information . . . . .	257
Viewing selected zone configuration information . . . . .	258
Viewing the configuration in the effective zone database . . . . .	258
Clearing all zone configurations . . . . .	258
Zone object maintenance. . . . .	259
Copying a zone object . . . . .	259
Deleting a zone object . . . . .	259
Renaming a zone object . . . . .	260
Zoning configuration management . . . . .	261
New switch or fabric additions . . . . .	261
Fabric segmentation and zoning. . . . .	263
Security and zoning. . . . .	263
Zone merging scenarios . . . . .	264

## Chapter 12

### Traffic Isolation Zoning

In this chapter . . . . .	267
Traffic Isolation Zoning overview . . . . .	267
TI zone failover . . . . .	268
FSPF routing rules and traffic isolation . . . . .	270
Enhanced TI zones . . . . .	272
Traffic Isolation Zoning over FC routers. . . . .	273
TI within an edge fabric . . . . .	274
TI within a backbone fabric. . . . .	275
Limitations of TI zones over FC routers . . . . .	276
General rules for TI zones. . . . .	276
Supported configurations for Traffic Isolation Zoning . . . . .	277
Additional configuration rules for enhanced TI zones. . . . .	278
Trunking with TI zones . . . . .	278
Limitations and restrictions of Traffic Isolation Zoning . . . . .	278
Admin Domain considerations for Traffic Isolation Zoning . . . . .	279
Virtual Fabric considerations for Traffic Isolation Zoning. . . . .	279
Traffic Isolation Zoning over FC routers with Virtual Fabrics . . . . .	281
Creating a TI zone . . . . .	282
Creating a TI zone in a base fabric. . . . .	284
Modifying TI zones. . . . .	284
Changing the state of a TI zone . . . . .	285

	Deleting a TI zone . . . . .	286
	Displaying TI zones . . . . .	286
	Setting up TI over FCR (sample procedure). . . . .	287
<b>Chapter 13</b>	<b>Administering NPIV</b>	
	In this chapter . . . . .	291
	NPIV overview . . . . .	291
	Upgrade considerations . . . . .	292
	Fixed addressing mode . . . . .	292
	10-bit addressing mode . . . . .	292
	Configuring NPIV . . . . .	293
	Enabling and disabling NPIV . . . . .	294
	Viewing NPIV port configuration information . . . . .	294
	Viewing virtual PID login information . . . . .	296
<b>Chapter 14</b>	<b>Interoperability for Merged SANs</b>	
	In this chapter . . . . .	297
	Interoperability overview. . . . .	297
	Connectivity solutions. . . . .	298
	Domain ID offset modes. . . . .	299
	Configuring the Domain_ID offset . . . . .	301
	McDATA Fabric mode configuration restrictions . . . . .	301
	McDATA Open Fabric mode configuration restrictions . . . . .	302
	Interoperability support for logical switches . . . . .	302
	Switch configurations for interoperability . . . . .	303
	Enabling McDATA Open Fabric mode . . . . .	303
	Enabling McDATA Fabric mode . . . . .	304
	Enabling Brocade Native mode. . . . .	305
	Zone management in interoperable fabrics . . . . .	306
	Zoning restrictions . . . . .	306
	Zone name restrictions . . . . .	307
	Zoning modes. . . . .	307
	Setting the safe zone mode on a stand-alone switch . . . . .	308
	Setting the safe zone mode fabric-wide. . . . .	308
	Disabling safe zone mode. . . . .	308
	Effective zone configuration . . . . .	309
	Saving the effective zone configuration to the Defined Database. . . . .	309
	Frame Redirection in interoperable fabrics. . . . .	310
	Traffic Isolation zones in interoperable fabrics. . . . .	310
	Brocade SANtegrity implementation in mixed fabric SANS . . . . .	311
	Fabric OS Layer 2 Fabric Binding . . . . .	311

E_Port authentication between Fabric OS and M-EOS switches . . .	311
Switch authentication policy . . . . .	313
Dumb switch authentication . . . . .	315
Authentication of EX_Port, VE_Port, and VEX_Port connections	316
Authentication of VE_Port-to-VE_Port connections . . . . .	317
Authentication of VEX_Port-to-VE_Port connections . . . . .	320
Authentication of VEX_Port-to-VEX_Port connections . . . . .	321
FCR SANtegrity . . . . .	321
Fabric Binding behavior in a mixed fabric . . . . .	322
Translate domains do not have Preferred or Insistent Domain ID behavior. . . . .	322
Configuring the preferred domain ID and the insistent domain ID	322
FICON implementation in a mixed fabric. . . . .	323
Fabric OS version change restrictions in an interoperable environment	323
Coordinated Hot Code Load . . . . .	324
Bypassing the Coordinated HCL check on firmware download	324
Coordinated HCL on switches firmware downloads . . . . .	325
Upgrade and downgrade considerations for HCL for interoperability	325
McDATA-aware features . . . . .	325
McDATA-unaware features . . . . .	326
M-EOS feature limitations in mixed fabrics . . . . .	328
Supported hardware in an interoperable environment . . . . .	329
Supported features in an interoperable environment . . . . .	331
Unsupported features in an interoperable environment . . . . .	334

## Chapter 15

### Managing Administrative Domains

In this chapter . . . . .	335
Administrative Domains overview . . . . .	335
Admin Domain features. . . . .	337
Requirements for Admin Domains . . . . .	337
Admin Domain access levels. . . . .	338
User-defined Administrative Domains . . . . .	338
System-defined Administrative Domains . . . . .	338
Admin Domains and login . . . . .	340
Admin Domain member types. . . . .	341
Admin Domains and switch WWN. . . . .	342
Admin Domain compatibility, availability, and merging. . . . .	344



Admin Domain management for physical fabric administrators . . . . .	344
Setting the default zoning mode for Admin Domains . . . . .	344
Creating an Admin Domain . . . . .	345
User assignments to Admin Domains . . . . .	346
Removing an Admin Domain from a user account . . . . .	348
Activating an Admin Domain . . . . .	348
Deactivating an Admin Domain . . . . .	349
Adding members to an existing Admin Domain . . . . .	349
Removing members from an Admin Domain . . . . .	350
Renaming an Admin Domain . . . . .	350
Deleting an Admin Domain . . . . .	351
Deleting all user-defined Admin Domains . . . . .	352
Deleting all user-defined Admin Domains non-disruptively . . . . .	352
Validating an Admin Domain member list . . . . .	356
SAN management with Admin Domains . . . . .	356
CLI commands in an AD context . . . . .	357
Executing a command in a different AD context . . . . .	357
Displaying an Admin Domain configuration . . . . .	358
Switching to a different Admin Domain context . . . . .	358
Admin Domain interactions with other Fabric OS features . . . . .	359
Admin Domains, zones, and zone databases . . . . .	360
Admin Domains and LSAN zones . . . . .	362
Configuration upload and download in an AD context . . . . .	362

## **Section II                      Licensed Features**

### **Chapter 16**

#### **Administering Licensing**

In this chapter . . . . .	365
Licensing overview . . . . .	365
The Brocade 7800 Upgrade license . . . . .	371
ICL licensing . . . . .	371
ICL 16-link license . . . . .	371
ICL 8-link license . . . . .	371
8G licensing . . . . .	372
Slot-based licensing . . . . .	372
Upgrade/downgrade considerations . . . . .	373
Adding a license to a slot . . . . .	373
Removing a license from a slot . . . . .	373
Time-based licenses . . . . .	373
Configupload and download considerations . . . . .	374
Expired licenses . . . . .	374
Universal Time-based licenses . . . . .	374
Universal Time-based license expiration date . . . . .	374
Extending a license . . . . .	375
Deleting a license . . . . .	375
Date change restriction . . . . .	375
Universal Time-based license shelf life . . . . .	375

Viewing installed licenses . . . . .	375
Activating a license . . . . .	375
Adding a licensed feature . . . . .	376
Removing a licensed feature . . . . .	377
Ports on Demand . . . . .	377
Activating Ports on Demand . . . . .	379
Dynamic Ports on Demand . . . . .	379
Displaying the port license assignments . . . . .	379
Enabling Dynamic Ports on Demand . . . . .	380
Disabling Dynamic Ports on Demand . . . . .	380
Reserving a port license . . . . .	381
Releasing a port from a POD set . . . . .	382

## Chapter 17

### Monitoring Fabric Performance

In this chapter . . . . .	383
Advanced Performance Monitoring overview . . . . .	383
Types of monitors . . . . .	383
Virtual Fabrics considerations for Advanced Performance Monitoring . . . . .	384
End-to-end performance monitoring . . . . .	385
End-to-end monitors . . . . .	385
Adding end-to-end monitors . . . . .	386
Setting a mask for an end-to-end monitor . . . . .	387
Deleting end-to-end monitors . . . . .	388
Frame monitoring . . . . .	389
Creating frame types to be monitored . . . . .	390
Deleting frame types . . . . .	391
Adding frame monitors to a port . . . . .	391
Removing frame monitors from a port . . . . .	391
Saving frame monitor configuration . . . . .	391
Displaying frame monitors . . . . .	392
Clearing frame monitor counters . . . . .	392
ISL performance monitoring . . . . .	393
Top Talker monitors . . . . .	393
Adding a Top Talker monitor on an F_Port . . . . .	394
Adding Top Talker monitors on all switches in the fabric (fabric mode) . . . . .	394
Displaying the top <i>n</i> bandwidth-using flows on an F_Port . . . . .	395
Displaying top talking flows for a given domain ID (fabric mode) . . . . .	396
Deleting a Top Talker monitor on an F_Port . . . . .	396
Deleting the fabric mode Top Talker monitors . . . . .	396
Limitations of Top Talker monitors . . . . .	397
Trunk monitoring . . . . .	397
Displaying end-to-end and ISL monitor counters . . . . .	397
Clearing end-to-end and ISL monitor counters . . . . .	398
Saving and restoring monitor configurations . . . . .	399

	Performance data collection .....	399
<b>Chapter 18</b>	<b>Optimizing Fabric Behavior</b>	
	In this chapter .....	401
	Adaptive Networking overview .....	401
	Ingress Rate Limiting .....	402
	Limiting traffic from a particular device .....	403
	Disabling ingress rate limiting .....	403
	QoS: SID/DID traffic prioritization .....	403
	License requirements for traffic prioritization .....	404
	QoS zones .....	406
	QoS on E_Ports .....	407
	QoS over FC routers .....	408
	Virtual Fabric considerations for traffic prioritization .....	409
	High availability considerations for traffic prioritization .....	410
	Supported configurations for traffic prioritization .....	410
	Upgrade considerations for traffic prioritization .....	410
	Limitations and restrictions for traffic prioritization .....	413
	Setting traffic prioritization .....	414
	Setting traffic prioritization over FC routers .....	415
	Disabling QoS .....	416
	Bottleneck detection .....	416
	Supported configurations for bottleneck detection .....	417
	How bottlenecks are reported .....	417
	Limitations of bottleneck detection .....	417
	High availability considerations for bottleneck detection .....	417
	Upgrade and downgrade considerations for bottleneck detection .....	418
	Trunking considerations for bottleneck detection .....	418
	Virtual Fabrics considerations for bottleneck detection .....	418
	Access Gateway considerations for bottleneck detection .....	418
	Enabling bottleneck detection on a switch .....	419
	Excluding a port from bottleneck detection .....	419
	Displaying bottleneck detection configuration details .....	420
	Changing bottleneck alert parameters .....	420
	Displaying bottleneck statistics .....	422
	Disabling bottleneck detection on a switch .....	423
<b>Chapter 19</b>	<b>Managing Trunking Connections</b>	
	In this chapter .....	425
	Trunking overview .....	425
	Criteria for managing trunking connections .....	426
	Supported hardware .....	427
	Recommendations for trunking groups .....	427

Basic trunk group configuration . . . . .	428
Re-initializing ports for trunking . . . . .	428
Enabling Trunking on a port . . . . .	428
Enabling Trunking on a switch . . . . .	428
Displaying trunking information . . . . .	429
Trunking over long distance fabrics . . . . .	430
F_Port trunking . . . . .	431
Prerequisites for F_Port trunking . . . . .	431
Enabling F_Port trunking . . . . .	432
Disabling F_Port trunking . . . . .	432
F_Port trunking in Virtual Fabrics . . . . .	432
F_Port trunking considerations for Virtual Fabrics . . . . .	433
F_Port masterless trunking . . . . .	433
F_Port masterless trunking considerations . . . . .	435
Assigning a Trunk Area . . . . .	437
Enabling the DCC policy on a Trunk Area . . . . .	439

## Chapter 20

### Managing Long Distance Fabrics

In this chapter . . . . .	441
Long distance fabrics overview . . . . .	441
Extended Fabrics device limitations . . . . .	442
Long distance link modes . . . . .	442
Configuring an extended ISL . . . . .	443
Enabling long distance when connecting to TDM devices . . . . .	444
Buffer credit management . . . . .	445
Buffer-to-Buffer flow control . . . . .	445
Optimal buffer credit allocation . . . . .	446
Fibre Channel gigabit values reference definition . . . . .	447
Allocating buffer credits based on full-size frames . . . . .	447
Allocating buffer credits based on average-size frames . . . . .	449
Allocating buffer credits for F_Ports . . . . .	450
Displaying the remaining buffers in a port group . . . . .	450
Buffer credits for each switch model . . . . .	451
Maximum configurable distances for Extended Fabrics . . . . .	452
Buffer credit recovery . . . . .	453

## Chapter 21

### Using the FC-FC Routing Service

In this chapter . . . . .	455
FC-FC routing service overview . . . . .	455
Supported platforms for Fibre Channel routing . . . . .	456
Supported configurations . . . . .	456
Integrated Routing . . . . .	457

Fibre Channel routing concepts . . . . .	457
Proxy devices . . . . .	461
Routing types . . . . .	461
Phantom domains . . . . .	462
Setting up the FC-FC routing service . . . . .	464
Verifying the setup for FC-FC routing . . . . .	464
Backbone fabric IDs . . . . .	466
Assigning backbone fabric IDs . . . . .	467
FCIP tunnel configuration . . . . .	467
Inter-fabric link configuration . . . . .	468
Configuring an IFL for both edge and backbone connections	468
FC Router port cost configuration . . . . .	471
Port cost considerations . . . . .	472
Setting router port cost for an EX_Port. . . . .	473
EX_Port frame trunking configuration . . . . .	474
Masterless EX_Port trunking. . . . .	474
Supported configurations and platforms . . . . .	475
Configuring EX_Port frame trunking . . . . .	476
Displaying EX_Port trunking information . . . . .	476
LSAN zone configuration . . . . .	477
Use of Admin Domains with LSAN zones and FCR . . . . .	477
Zone definition and naming . . . . .	477
LSAN zones and fabric-to-fabric communications. . . . .	478
Controlling device communication with the LSAN. . . . .	478
Setting the maximum LSAN count . . . . .	480
Configuring backbone fabrics for interconnectivity . . . . .	481
HA and downgrade considerations for LSAN zones . . . . .	481
LSAN zone policies using LSAN tagging . . . . .	481
LSAN zone binding. . . . .	485
Proxy PID configuration. . . . .	489
Fabric parameter considerations. . . . .	489
Inter-fabric broadcast frames. . . . .	490
Displaying the current broadcast configuration. . . . .	490
Enabling broadcast frame forwarding . . . . .	491
Disabling broadcast frame forwarding . . . . .	491
Resource monitoring. . . . .	491
FC-FC Routing and Virtual Fabrics . . . . .	492
Logical switch configuration for FC routing . . . . .	493
Backbone-to-edge routing with Virtual Fabrics . . . . .	494
Upgrade and downgrade considerations for FC-FC routing . . . . .	495
How replacing port blades affects EX_Port configuration. . . . .	495
Displaying the range of output ports connected to xlate domains	496

## Appendix A

### M-EOS Migration Path to Fabric OS

In this appendix. . . . .	497
---------------------------	-----

	M-EOS fabrics overview . . . . .	497
	McDATA Mi10K interoperability . . . . .	499
	Fabric configurations for interconnectivity . . . . .	499
	Connectivity modes . . . . .	499
	Configuring the FC router . . . . .	500
	Configuring LSAN zones in the M-EOS fabric . . . . .	502
	Correcting errors if LSAN devices appear in only one of the fabrics	502
	Completing the configuration . . . . .	503
<b>Appendix B</b>	<b>Inband Management</b>	
	In this appendix . . . . .	505
	Inband Management overview . . . . .	505
	Internal Ethernet devices . . . . .	506
	IP address and routing management . . . . .	506
	Setting the IP address for the 7500s . . . . .	507
	Setting the IP address for the CP Inband Management interface	507
	Setting the IP address for the GE Inband Management interface	507
	Adding an Inband Management route on the CP . . . . .	507
	Deleting an Inband Management route . . . . .	508
	Viewing Inband Management IP addresses and routes . . . .	508
	FIPS . . . . .	509
	Examples of supported configurations . . . . .	509
	Configuring a Management Station on the same subnet . . .	509
	Configuring a Management Station on different subnets . . .	510
<b>Appendix C</b>	<b>Port Indexing</b>	
	In this appendix . . . . .	513
	Port indexing on the Brocade 48000 director . . . . .	513
	Port indexing on the Brocade DCX backbone . . . . .	515
	Port indexing on the Brocade DCX-4S backbone . . . . .	517
<b>Appendix D</b>	<b>FIPS Support</b>	
	In this appendix . . . . .	521
	FIPS overview . . . . .	521
	Zeroization functions . . . . .	521
	Power-up self tests . . . . .	522
	Conditional tests . . . . .	522
	FIPS mode configuration . . . . .	523
	LDAP in FIPS mode . . . . .	524
	LDAP certificates for FIPS mode . . . . .	526

Preparing the switch for FIPS .....	527
Overview of steps .....	527
Enabling FIPS mode .....	528
Disabling FIPS mode .....	529
Zeroizing for FIPS .....	530
Displaying FIPS configuration .....	530

**Appendix E**

**Hexadecimal**

Hexadecimal overview .....	531
Example conversion of the hexadecimal triplet 0x616000 ..	531

**Index**





# Figures

---

<b>Figure 1</b>	Well-known addresses . . . . .	3
<b>Figure 2</b>	Identifying the blades . . . . .	51
<b>Figure 3</b>	Blade swap with Virtual Fabrics during the swap . . . . .	52
<b>Figure 4</b>	Blade swap with Virtual Fabrics after the swap . . . . .	52
<b>Figure 5</b>	Principal ISLs . . . . .	64
<b>Figure 6</b>	New switch added to existing fabric . . . . .	66
<b>Figure 7</b>	Virtual Channels on a 1/2/4 Gbps ISL . . . . .	68
<b>Figure 8</b>	Virtual Channels on an 8 Gbps ISL . . . . .	69
<b>Figure 9</b>	Gateway link merges SAN . . . . .	70
<b>Figure 10</b>	DCX-4S allowed ICL connections . . . . .	71
<b>Figure 11</b>	ICL triangular topology . . . . .	73
<b>Figure 12</b>	Single Host and Target . . . . .	82
<b>Figure 13</b>	Windows 2000 VSA configuration . . . . .	103
<b>Figure 14</b>	Example of a Brocade DCT file . . . . .	110
<b>Figure 15</b>	Example of the <i>dictiona.dcm file</i> . . . . .	110
<b>Figure 16</b>	DH-CHAP authentication . . . . .	144
<b>Figure 17</b>	Protected endpoints configuration . . . . .	165
<b>Figure 18</b>	Gateway tunnel configuration . . . . .	166
<b>Figure 19</b>	Endpoint to gateway tunnel configuration . . . . .	166
<b>Figure 20</b>	Switch before and after enabling Virtual Fabrics . . . . .	211
<b>Figure 21</b>	Switch before and after creating logical switches . . . . .	211
<b>Figure 22</b>	Fabric IDs assigned to logical switches . . . . .	212
<b>Figure 23</b>	Assigning ports to logical switches . . . . .	213
<b>Figure 24</b>	Logical switches connected to devices and non-Virtual Fabric switch . . . . .	214
<b>Figure 25</b>	Logical switches in a single chassis belong to separate fabrics . . . . .	214
<b>Figure 26</b>	Logical switches connected to other logical switches through physical ISLs . . . . .	215
<b>Figure 27</b>	Logical switches connected to form logical fabrics . . . . .	215
<b>Figure 28</b>	Base switches connected by an XISL . . . . .	216
<b>Figure 29</b>	Logical ISLs connecting logical switches . . . . .	217
<b>Figure 30</b>	Logical fabric using ISLs and XISLs . . . . .	218
<b>Figure 31</b>	Example of logical fabrics in multiple chassis and XISLs . . . . .	234
<b>Figure 32</b>	Zoning example . . . . .	239
<b>Figure 33</b>	Broadcast zones and Admin Domains . . . . .	245
<b>Figure 34</b>	Traffic Isolation zone creating a dedicated path through the fabric . . . . .	268
<b>Figure 35</b>	Fabric incorrectly configured for TI zone with failover disabled . . . . .	270
<b>Figure 36</b>	Dedicated path is the only shortest path . . . . .	271

<b>Figure 37</b>	Dedicated path is not the shortest path . . . . .	271
<b>Figure 38</b>	Enhanced TI zones . . . . .	272
<b>Figure 39</b>	Illegal ETIZ configuration . . . . .	273
<b>Figure 40</b>	Traffic Isolation Zoning over FCR . . . . .	274
<b>Figure 41</b>	TI zone in an edge fabric . . . . .	274
<b>Figure 42</b>	TI zone in a backbone fabric . . . . .	275
<b>Figure 43</b>	TI zone misconfiguration . . . . .	277
<b>Figure 44</b>	Dedicated path with Virtual Fabrics . . . . .	280
<b>Figure 45</b>	Creating a TI zone in a logical fabric . . . . .	280
<b>Figure 46</b>	Creating a TI zone in a base fabric . . . . .	280
<b>Figure 47</b>	Example configuration for TI zones over FC routers in logical fabrics . . . . .	281
<b>Figure 48</b>	Logical representation of TI zones over FC routers in logical fabrics . . . . .	282
<b>Figure 49</b>	TI over FCR example . . . . .	287
<b>Figure 50</b>	Typical direct E_Port configuration . . . . .	299
<b>Figure 51</b>	Fabric with two Admin Domains . . . . .	336
<b>Figure 52</b>	Filtered fabric views when using Admin Domains . . . . .	336
<b>Figure 53</b>	Fabric with ADO and AD255 . . . . .	340
<b>Figure 54</b>	Fabric showing switch and device WWNs . . . . .	343
<b>Figure 55</b>	Filtered fabric views showing converted switch WWNs . . . . .	343
<b>Figure 56</b>	ADO and two user-defined Admin Domains, AD1 and AD2 . . . . .	354
<b>Figure 57</b>	ADO with three zones . . . . .	354
<b>Figure 58</b>	Setting end-to-end monitors on a port . . . . .	386
<b>Figure 59</b>	Proper placement of end-to-end performance monitors . . . . .	387
<b>Figure 60</b>	Mask positions for end-to-end monitors . . . . .	388
<b>Figure 61</b>	QoS traffic prioritization . . . . .	407
<b>Figure 62</b>	QoS with E_Ports enabled . . . . .	408
<b>Figure 63</b>	Traffic prioritization in a logical fabric . . . . .	409
<b>Figure 64</b>	Distribution of traffic over ISL Trunking groups . . . . .	426
<b>Figure 65</b>	Trunk group configuration for the Brocade 5100 . . . . .	431
<b>Figure 66</b>	Switch in Access Gateway mode without F_Port trunking . . . . .	434
<b>Figure 67</b>	Switch in Access Gateway mode with F_Port masterless trunking . . . . .	434
<b>Figure 68</b>	A metaSAN with inter-fabric links . . . . .	458
<b>Figure 69</b>	A metaSAN with edge-to-edge and backbone fabrics and LSAN zones . . . . .	459
<b>Figure 70</b>	Edge SANs connected through a backbone fabric . . . . .	460
<b>Figure 71</b>	MetaSAN with imported devices . . . . .	461
<b>Figure 72</b>	Sample topology (physical topology) . . . . .	463
<b>Figure 73</b>	EX_Port phantom switch topology . . . . .	463
<b>Figure 74</b>	Example of setting up Speed LSAN tag . . . . .	483
<b>Figure 75</b>	LSAN zone binding . . . . .	486
<b>Figure 76</b>	EX_Ports in a base switch . . . . .	494
<b>Figure 77</b>	Logical representation of EX_Ports in a base switch . . . . .	494
<b>Figure 78</b>	Backbone-to-edge routing across base switch using FC router in legacy mode . . . . .	495

<b>Figure 79</b>	Inband Management process .....	506
<b>Figure 80</b>	Management Station on same subnet .....	509
<b>Figure 81</b>	Management Station on a different subnet .....	511



# Tables

---

<b>Table 1</b>	Daemons that are automatically restarted . . . . .	13
<b>Table 2</b>	Default administrative account names and passwords . . . . .	19
<b>Table 3</b>	Port numbering schemes for the Brocade 48000, Brocade DCX and DCX-4S enterprise-class platforms 40	
<b>Table 4</b>	Brocade enterprise-class platform terminology and abbreviations . . . . .	44
<b>Table 5</b>	Port blades supported by each platform . . . . .	46
<b>Table 6</b>	Blade compatibility within a Brocade DCX and DCX-4S backbone . . . . .	47
<b>Table 7</b>	<b>AuditCfg</b> event class operands . . . . .	60
<b>Table 8</b>	LED behavior . . . . .	72
<b>Table 9</b>	Combinations of routing policy and IOD with Lossless DLS enabled . . . . .	79
<b>Table 10</b>	Fabric OS roles . . . . .	84
<b>Table 11</b>	Permission types . . . . .	85
<b>Table 12</b>	RBAC permissions matrix . . . . .	85
<b>Table 13</b>	Maximum number of simultaneous sessions . . . . .	87
<b>Table 14</b>	Default local user accounts . . . . .	88
<b>Table 15</b>	Authentication configuration options . . . . .	100
<b>Table 16</b>	Syntax for VSA-based account roles . . . . .	102
<b>Table 17</b>	dictionary.brocade file entries . . . . .	103
<b>Table 18</b>	Secure protocol support . . . . .	117
<b>Table 19</b>	Items needed to deploy secure protocols . . . . .	118
<b>Table 20</b>	Main security scenarios . . . . .	118
<b>Table 21</b>	SSL certificate files . . . . .	123
<b>Table 22</b>	Blocked listener applications . . . . .	131
<b>Table 23</b>	Access defaults . . . . .	131
<b>Table 24</b>	Port information . . . . .	132
<b>Table 25</b>	Valid methods for specifying policy members . . . . .	134
<b>Table 26</b>	FCS policy states . . . . .	137
<b>Table 27</b>	FCS switch operations . . . . .	138
<b>Table 28</b>	Distribution policy states . . . . .	140
<b>Table 29</b>	DCC policy states . . . . .	141
<b>Table 30</b>	SCC policy states . . . . .	143
<b>Table 31</b>	FCAP certificate files . . . . .	151
<b>Table 32</b>	Supported services . . . . .	155
<b>Table 33</b>	Implicit IP Filter rules . . . . .	156
<b>Table 34</b>	Default IP policy rules . . . . .	156
<b>Table 35</b>	Interaction between fabric-wide consistency policy and distribution settings . . . . .	159

<b>Table 36</b>	Supported policy databases .....	159
<b>Table 37</b>	Fabric-wide consistency policy settings .....	161
<b>Table 38</b>	Merging fabrics with matching fabric-wide consistency policies.....	163
<b>Table 39</b>	Examples of strict fabric merges .....	164
<b>Table 40</b>	Fabric merges with tolerant/absent combinations .....	164
<b>Table 41</b>	Algorithms and associated authentication policies .....	168
<b>Table 42</b>	CLI commands to display or modify switch configuration information .....	181
<b>Table 43</b>	Brocade configuration and connection.....	187
<b>Table 44</b>	Enterprise-class platform HA sync states .....	191
<b>Table 45</b>	Blade and port types supported on logical switches .....	221
<b>Table 46</b>	Virtual Fabrics interaction with Fabric OS features .....	222
<b>Table 47</b>	Maximum number of logical switches per chassis.....	222
<b>Table 48</b>	Types of zoning.....	239
<b>Table 49</b>	Approaches to fabric-based zoning.....	240
<b>Table 50</b>	Considerations for zoning architecture.....	243
<b>Table 51</b>	Zone merging scenarios.....	264
<b>Table 52</b>	Comparison of traffic behavior when failover is enabled or disabled in TI zones	269
<b>Table 53</b>	Number of supported NPIV devices .....	292
<b>Table 54</b>	Internal representations of ID domain offsets in IM2.....	300
<b>Table 55</b>	Internal representations of ID domain offsets in IM3.....	300
<b>Table 56</b>	Fabric OS switch authentication types .....	312
<b>Table 57</b>	Fabric OS mode descriptions.....	312
<b>Table 58</b>	DH group types .....	312
<b>Table 59</b>	Device authentication mode .....	313
<b>Table 60</b>	Switch authentication policy when all secrets are correct.....	313
<b>Table 61</b>	Switch authentication policy - Fabric OS switch with incorrect peer secret for M-EOS switch	314
<b>Table 62</b>	Switch authentication policy-M-EOS switch with the incorrect peer secret for Fabric OS switch	315
<b>Table 63</b>	Switch authentication policy when connected to an M-EOS dumb switch....	316
<b>Table 64</b>	VE_Port-to-VE_Port authentication policy with correct switch secret .....	317
<b>Table 65</b>	VE_Port-to-VE_Port authentication policy with unknown switch secret .....	319
<b>Table 66</b>	VEX_Port-to-VE_Port authentication policy with correct secrets .....	321
<b>Table 67</b>	VEX_ Port-to-VE_Port authentication policy when secrets are not correct....	321
<b>Table 68</b>	McDATA-aware features.....	325
<b>Table 69</b>	McDATA-unaware features.....	326
<b>Table 70</b>	Complete feature compatibility matrix .....	326
<b>Table 71</b>	Fabric OS interoperability with M-EOS.....	330
<b>Table 72</b>	Supported Fabric OS features .....	332
<b>Table 73</b>	AD user types .....	338
<b>Table 74</b>	Ports and devices in CLI output.....	357
<b>Table 75</b>	Admin Domain interaction with Fabric OS features.....	359

<b>Table 76</b>	Configuration upload and download scenarios in an AD context . . . . .	362
<b>Table 77</b>	Available Brocade licenses . . . . .	366
<b>Table 78</b>	License requirements. . . . .	368
<b>Table 79</b>	Base to Upgrade License Comparison . . . . .	371
<b>Table 80</b>	List of available ports when implementing PODs. . . . .	378
<b>Table 81</b>	Types of monitors supported on Brocade switch models . . . . .	384
<b>Table 82</b>	Number of logical switches that support performance monitors . . . . .	384
<b>Table 83</b>	Maximum number of frame monitors and offsets per port. . . . .	389
<b>Table 84</b>	Predefined values at offset 0. . . . .	390
<b>Table 85</b>	Virtual channels assigned to QoS priority . . . . .	403
<b>Table 86</b>	Trunking support for Brocade 4100 and 4900 . . . . .	430
<b>Table 87</b>	Trunking over distance for the Brocade 48000, DCX Backbone, and the DCX-4S . . . . .	431
<b>Table 88</b>	PWWN format for F_Port and N_Port trunk ports. . . . .	434
<b>Table 89</b>	F_Port masterless trunking considerations . . . . .	435
<b>Table 90</b>	Address identifier . . . . .	438
<b>Table 91</b>	Fibre Channel data frames . . . . .	447
<b>Table 92</b>	Buffer credits . . . . .	451
<b>Table 93</b>	Configurable distances for Extended Fabrics. . . . .	452
<b>Table 94</b>	Supported platforms and VF mode for masterless EX_Port trunking. . . . .	475
<b>Table 95</b>	LSAN information stored in each FC router with and without LSAN zone binding . . . . .	486
<b>Table 96</b>	Fabric OS and M-EOSc interoperability compatibility matrix. . . . .	497
<b>Table 97</b>	Fabric OS and M-EOSn interoperability compatibility matrix. . . . .	498
<b>Table 98</b>	portCfgEXPort -m values. . . . .	500
<b>Table 99</b>	Default index/area_ID core PID assignment with no port swap for the Brocade 48000 director . . . . .	513
<b>Table 100</b>	Default index/16-bit PID assignment with no port swap on a Brocade DCX backbone . . . . .	515
<b>Table 101</b>	Default index/16-bit PID assignment with no port swap for the Brocade DCX-4S . . . . .	518
<b>Table 102</b>	Zeroization behavior. . . . .	521
<b>Table 103</b>	FIPS mode restrictions. . . . .	523
<b>Table 104</b>	FIPS and non-FIPS modes of operation . . . . .	524
<b>Table 105</b>	Active Directory keys to modify . . . . .	525
<b>Table 106</b>	Decimal to hexadecimal conversion table . . . . .	532





# About This Document

---

## In this chapter

- [How this document is organized](#) ..... xxxiii
- [Supported hardware and software](#)..... xxxiv
- [What's new in this document](#)..... xxxv
- [Document conventions](#) ..... xxxv
- [Additional information](#)..... xxxvii
- [Getting technical help](#) ..... xxxviii
- [Document feedback](#) ..... xxxix

## How this document is organized

The document is divided into two sections; the first, “Standard Features,” contains the following topics:

- [Chapter 1, “Understanding Fibre Channel Services,”](#) provides information on the Fibre Channel services on Brocade switches.
- [Chapter 2, “Performing Basic Configuration Tasks,”](#) gives a brief overview of Fabric OS, explains the Fabric OS CLI Help feature, and provides typical connection and configuration procedures.
- [Chapter 3, “Performing Advanced Configuration Tasks,”](#) provides advanced connection and configuration procedures.
- [Chapter 4, “Routing Traffic,”](#) provides information and procedures for using switch routing features.
- [Chapter 5, “Managing User Accounts,”](#) provides information and procedures on managing authentication and user accounts for the switch management channel.
- [Chapter 6, “Configuring Protocols,”](#) provides procedures for basic password and user account management.
- [Chapter 7, “Configuring Security Policies,”](#) provides information and procedures for configuring ACL policies for FC port and switch binding and managing the fabric-wide consistency policy.
- [Chapter 8, “Maintaining the Switch Configuration File,”](#) provides procedures for maintaining and backing up your switch configurations.
- [Chapter 9, “Installing and Maintaining Firmware,”](#) provides preparations and procedures for performing firmware downloads.
- [Chapter 10, “Managing Virtual Fabrics,”](#) describes the concepts and provides procedures for using Virtual Fabrics.

- [Chapter 11, “Administering Advanced Zoning,”](#) provides procedures for use of the Brocade Advanced Zoning feature.
- [Chapter 12, “Traffic Isolation Zoning,”](#) provides concepts and procedures for use of Traffic Isolation Zones within a fabric.
- [Chapter 13, “Administering NPIV,”](#) provides procedures for enabling and configuring N-Port ID Virtualization (NPIV).
- [Chapter 14, “Interoperability for Merged SANs,”](#) provides information about using Brocade switches with other brands of switches.
- [Chapter 15, “Managing Administrative Domains,”](#) describes the concepts and provides procedures for using administrative domains.

The second section, “Licensed Features,” contains the following topics:

- [Chapter 16, “Administering Licensing,”](#) provides information about Brocade licenses and their implementation on switches and enterprise-class directors.
- [Chapter 17, “Monitoring Fabric Performance,”](#) provides procedures for use of the Brocade Advanced Performance Monitoring licensed feature.
- [Chapter 18, “Optimizing Fabric Behavior,”](#) provides procedures for use of the Brocade Adaptive Networking suite of tools, including Traffic Isolation, QoS Ingress Rate Limiting, and QoS SID/DID Traffic Prioritization.
- [Chapter 19, “Managing Trunking Connections,”](#) provides procedures for use of the Brocade ISL Trunking licensed feature.
- [Chapter 20, “Managing Long Distance Fabrics,”](#) provides procedures for use of the Brocade Extended Fabrics licensed feature.
- [Chapter 21, “Using the FC-FC Routing Service,”](#) provides information for setting up and using the FC-FC Routing Service.
- The appendices provide special procedures or information for Fabric OS.

## Supported hardware and software

In those instances in which procedures or parts of procedures documented here apply to some switches but not to others, this guide identifies exactly which switches are supported and which are not.

Although many different software and hardware configurations are tested and supported by Brocade Communications Systems, Inc. for Fabric OS v6.4.0, documenting all possible configurations and scenarios is beyond the scope of this document.

The following hardware platforms are supported by this release of Fabric OS:

- Brocade 300 switch
- Brocade 4100 switch
- Brocade 4900 switch
- Brocade 5000 switch
- Brocade 5100 switch
- Brocade 5300 switch
- Brocade 5410 embedded switch

- Brocade 5424 embedded switch
- Brocade 5460 embedded switch
- Brocade 5470 embedded switch
- Brocade 5480 embedded switch
- Brocade 7500 extension switch
- Brocade 7500E extension switch
- Brocade 7600 application appliance
- Brocade 7800 extension switch
- Brocade 8000 application appliance
- Brocade 48000 director
- Brocade DCX Backbone data center backbone
- Brocade DCX-4S Backbone data center backbone
- Brocade VA-40FC

## What's new in this document

- Information that was added:
  - Support for new hardware platforms
    - Brocade VA-40FC switch
  - Information on device login behavior
  - 10-bit addressing mode enhancements
  - WWN-based PID assignment enhancements
  - NPIV enhancements
  - Blade compatibility
  - Loss Dynamic Load Sharing enhancements
  - FCAP authentication enhancements
  - Port indexing enhancements
  - Bottleneck detection enhancements
- Information that was deleted:
  - “Managing iSCSI Gateway Service,” which provides procedures for creating and maintaining iSCSI gateway services was removed from this manual and can be found in the *iSCSI Administrator's Guide*.

For further information about documentation updates for this release, refer to the release notes.

## Document conventions

This section describes text formatting conventions and important notice formats used in this document.

## Text formatting

The narrative-text formatting conventions that are used are as follows:

<b>bold text</b>	Identifies command names Identifies the names of user-manipulated GUI elements Identifies keywords and operands Identifies text to enter at the GUI or CLI
<i>italic text</i>	Provides emphasis Identifies variables Identifies paths and Internet addresses Identifies document titles
code text	Identifies CLI output Identifies command syntax examples

For readability, command names in the narrative portions of this guide are presented in mixed lettercase: for example, switchShow. In actual examples, command lettercase is often all lowercase. Otherwise, this manual specifically notes those cases in which a command is case sensitive.

## Command syntax conventions

Command syntax in this manual follows these conventions:

command	Commands are printed in bold.
--option, option	Command options are printed in bold.
-argument, arg	Arguments.
[ ]	Optional element.
variable	Variables are printed in italics. In the help pages, values are <u>underlined</u> or enclosed in angled brackets < >.
...	Repeat the previous element, for example “member[;member...]”
value	Fixed values following arguments are printed in plain font. For example, --show WWN
	Boolean. Elements are exclusive. Example: --show -mode egress   ingress

## Notes, cautions, and warnings

The following notices and statements are used in this manual. They are listed below in order of increasing severity of potential hazards.

---

### NOTE

A note provides a tip, guidance or advice, emphasizes important information, or provides a reference to related information.

---

### ATTENTION

An Attention statement indicates potential damage to hardware or data.

---



### **CAUTION**

A **Caution** statement alerts you to situations that can be potentially hazardous to you or cause damage to hardware, firmware, software, or data.



### **DANGER**

A **Danger** statement indicates conditions or situations that can be potentially lethal or extremely hazardous to you. Safety labels are also attached directly to products to warn of these conditions or situations.

## **Key terms**

For definitions specific to Brocade and Fibre Channel, see the *Brocade Glossary*.

For definitions of SAN-specific terms, visit the Storage Networking Industry Association online dictionary at:

<http://www.snia.org/education/dictionary>

## **Notice to the reader**

This document may contain references to the trademarks of the following corporations. These trademarks are the properties of their respective companies and corporations.

These references are made for informational purposes only.

Corporation	Referenced Trademarks and Products
Microsoft Corporation	Windows, Windows NT, Internet Explorer
Mozilla Corporation	Mozilla, Firefox
Netscape Communications Corporation	Netscape
Red Hat, Inc.	Red Hat, Red Hat Network, Maximum RPM, Linux Undercover
Sun Microsystems, Inc.	Sun, Solaris

## **Additional information**

This section lists additional Brocade and industry-specific documentation that you might find helpful.

### **Brocade resources**

To get up-to-the-minute information, go to <http://my.brocade.com> and register at no cost for a user ID and password.

For practical discussions about SAN design, implementation, and maintenance, you can obtain *Building SANs with Brocade Fabric Switches* through:

<http://www.amazon.com>

For additional Brocade documentation, visit the Brocade SAN Info Center and click the Resource Library location:

<http://www.brocade.com>

Release notes are available on the My Brocade web site and are also bundled with the Fabric OS firmware.

## Other industry resources

For additional resource information, visit the Technical Committee T11 Web site. This Web site provides interface standards for high-performance and mass storage applications for Fibre Channel, storage management, and other applications:

<http://www.t11.org>

For information about the Fibre Channel industry, visit the Fibre Channel Industry Association Web site:

<http://www.fibrechannel.org>

## Getting technical help

Contact your switch support supplier for hardware, firmware, and software support, including product repairs and part ordering. To expedite your call, have the following information available:

### 1. General Information

- Switch model
- Switch operating system version
- Error numbers and messages received
- **supportSave** command output
- Detailed description of the problem, including the switch or fabric behavior immediately following the problem, and specific questions
- Description of any troubleshooting steps already performed and the results
- Serial console and Telnet session logs
- syslog message logs

### 2. Switch Serial Number

The switch serial number and corresponding bar code are provided on the serial number label, as illustrated below.:

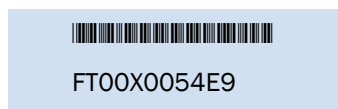

The serial number label is located as follows:

- *Brocade 5424* – On the bottom of the switch module.
- *Brocade 4100, 4900, and 7500* – On the switch ID pull-out tab located inside the chassis on the port side on the left.
- *Brocade 5000* – On the switch ID pull-out tab located on the bottom of the port side of the switch
- *Brocade 300, 5100, and 5300* – On the switch ID pull-out tab located on the bottom of the port side of the switch.
- *Brocade 7600, 7800, and 8000* – On the bottom of the chassis.
- *Brocade 48000* – Inside the chassis next to the power supply bays.
- *Brocade DCX Backbone* – On the bottom right on the port side of the chassis.
- *Brocade DCX-4S Backbone* – On the bottom right on the port side of the chassis.

### 3. World Wide Name (WWN)

Use the **wwn** command to display the switch WWN.

If you cannot use the **wwn** command because the switch is inoperable, you can get the WWN from the same place as the serial number, except for the Brocade DCX enterprise class platform. For the Brocade DCX enterprise class platform, access the numbers on the WWN cards by removing the Brocade logo plate at the top of the nonport side of the chassis.

For the Brocade 5424 embedded switch: Provide the license ID. Use the **licenseIDShow** command to display the WWN.

## Document feedback

Quality is our first concern at Brocade and we have made every effort to ensure the accuracy and completeness of this document. However, if you find an error or an omission, or you think that a topic needs further development, we want to hear from you. Forward your feedback to:

documentation@brocade.com

Provide the title and version number of the document and as much detail as possible about your comment, including the topic heading and page number and your suggestions for improvement.





# Standard Features

This section describes standard Fabric OS features, and includes the following chapters:

- [Chapter 1, “Understanding Fibre Channel Services”](#)
- [Chapter 2, “Performing Basic Configuration Tasks”](#)
- [Chapter 3, “Performing Advanced Configuration Tasks”](#)
- [Chapter 4, “Routing Traffic”](#)
- [Chapter 5, “Managing User Accounts”](#)
- [Chapter 6, “Configuring Protocols”](#)
- [Chapter 7, “Configuring Security Policies”](#)
- [Chapter 8, “Maintaining the Switch Configuration File”](#)
- [Chapter 9, “Installing and Maintaining Firmware”](#)
- [Chapter 10, “Managing Virtual Fabrics”](#)
- [Chapter 11, “Administering Advanced Zoning”](#)
- [Chapter 12, “Traffic Isolation Zoning”](#)
- [Chapter 13, “Administering NPIV”](#)
- [Chapter 14, “Interoperability for Merged SANs”](#)
- [Chapter 15, “Managing Administrative Domains”](#)



# Understanding Fibre Channel Services

## In this chapter

- Fibre Channel services overview ..... 3
- The Management Server..... 4
- Platform services..... 4
- Management server database..... 5
- Topology discovery..... 9
- Device login ..... 10
- High availability of daemon processes..... 12

## Fibre Channel services overview

Fibre Channel services define service functions such as the Name Server, Management Server, Security Key Distribution Server, and Time Server. Every Brocade switch has reserved three-byte addresses referred to as *well-known addresses*. These services provided by Brocade switches reside at these addresses and provide a service to either nodes or management applications in the fabric.

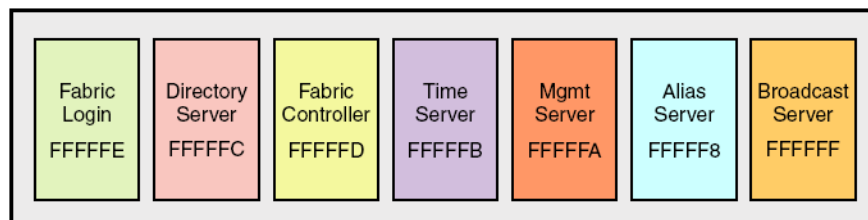

**FIGURE 1** Well-known addresses

**Fabric Login** – The Fabric Login server assigns a fabric address. This allows a fabric node to communicate with services on the switch or other nodes in the fabric. The fabric address assigned to a nodes is a 24-bit address (0x000000) containing three - 3-byte long nodes. Reading from left to right, the first node (0x000000), represents the domain ID, the second node (0x000000) the port area number of the port where the node is attached, and the third node (0x000000) the arbitrated loop physical address (AL\_PA), if applicable.

**Directory Server** – The Directory Server or Name Server is used to register fabric and public nodes and query to discover other devices in the fabric.

**Fabric Controller** – The Fabric Controller provides State Change Notifications (SCNs) to registered nodes when a change in the fabric topology occurs.

**Time Server** – The Time Server sends to the member switches in the fabric the time on either the principal switch or the primary Fabric Configuration Server (FCS) switch.

# 1 The Management Server

Management Server — The Management Server provides a single point for managing the fabric. The only service that is user-configurable is the Management Server.

Alias Server — The Alias Server keeps a group of nodes registered as one name to handle multicast groups.

Broadcast Server — The Broadcast Server is optional, and when frames are transmitted to this address they are broadcasted to all operational N\_ and NL\_Ports.

When registration and query frames are sent to a well-known address, a different protocol service, Fibre Channel Common Transport (FC-CT), is used. This protocol provides a simple, consistent format and behavior when a service provider is accessed for registration and query purposes.

## The Management Server

The Brocade Fabric OS Management Server (MS) allows a SAN management application to retrieve information and administer interconnected switches, servers, and storage devices. The management server assists in the autodiscovery of switch-based fabrics and their associated topologies.

A client of the management server can find basic information about the switches in the fabric and use this information to construct topology relationships. The management server also allows you to obtain certain switch attributes and, in some cases, modify them. For example, logical names identifying switches can be registered with the management server.

The management server provides several advantages for managing a Fibre Channel fabric:

- It is accessed by an external Fibre Channel node at the well-known address *FFFFFAh*, so an application can access information about the entire fabric management with minimal knowledge of the existing configuration.
- It is replicated on every Brocade switch within a fabric.
- It provides an unzoned view of the overall fabric configuration. This fabric topology view exposes the internal configuration of a fabric for management purposes; it contains interconnect information about switches and devices connected to the fabric. Under normal circumstances, a device (typically an FCP initiator) queries the Name Server for storage devices within its member zones. Because this limited view is not always sufficient, the management server provides the application with a list of the entire Name Server database.

## Platform services

By default, all management services except platform services are enabled; the MS platform service and topology discovery are disabled.

You can activate and deactivate the platform services throughout the fabric. Activating the platform services attempts to activate the MS platform service for each switch in the fabric. The change takes effect immediately and is committed to the configuration database of each affected switch. MS activation is persistent across power cycles and reboots.

---

### NOTE

The commands **mspIMgmtActivate** and **mspIMgmtDeactivate** are allowed only in ADO and AD255.

---

## Platform services in a Virtual Fabric

Each logical switch has a separate Platform Database. All platform registrations done to a logical switch are valid only in that particular logical switch's Virtual Fabric.

Activating the platform services on a switch or enterprise-class platform will activate platform services on all logical switches in a Virtual Fabric. Similarly, deactivating the platform services will deactivate the platform service on all logical switches in a Virtual Fabric. The **msPlatShow** command displays all platforms registered in a Virtual Fabric.

## Enabling platform services

When FCS policy is enabled, the **msplMgmtActivate** command can be issued only from the primary FCS switch.

The execution of the **msplMgmtActivate** command is subject to Admin Domain restrictions that may be in place.

1. Connect to the switch and log in using an account assigned to the admin role.
2. Enter the **msCapabilityShow** command to verify that all switches in the fabric support the MS platform service; otherwise, the next step will fail.
3. Enter the **msplMgmtActivate** command.

```
switch:admin> msplmgmtactivate
Request to activate MS Platform Service in progress.....
*Completed activating MS Platform Service in the fabric!
```

## Disabling platform services

1. Connect to the switch and log in using an account assigned to the admin role.
2. Enter the **msplMgmtDeactivate** command.
3. Enter **y** to confirm the deactivation.

```
switch:admin> msplmgmtdeactivate
MS Platform Service is currently enabled.
This will erase MS Platform Service configuration
information as well as database in the entire fabric.
Would you like to continue this operation? (yes, y, no, n): [no] y
Request to deactivate MS Platform Service in progress.....
*Completed deactivating MS Platform Service in the fabric!
```

# Management server database

You can control access to the management server database.

An access control list (ACL) of WWN addresses determines which systems have access to the management server database. The ACL typically contains those WWNs of host systems that are running management applications.

If the list is empty (the default), the management server is accessible to all systems connected in-band to the fabric. For more access security, you can specify WWNs in the ACL so that access to the management server is restricted to only those WWNs listed.

---

**NOTE**

The management server is logical switch-capable. All management server features are supported within a logical switch.

---

## Displaying the management server ACL

1. Connect to the switch and log in using an account assigned to the admin role.
2. Enter the **msConfigure** command.  
The command becomes interactive.
3. At the “select” prompt, enter **1** to display the access list.  
A list of WWNs that have access to the management server is displayed.

### Example of an empty access list

```
switch:admin> msconfigure
0      Done
1      Display the access list
2      Add member based on its Port/Node WWN
3      Delete member based on its Port/Node WWN
select : (0..3) [1] 1
MS Access list is empty.
0      Done
1      Display the access list
2      Add member based on its Port/Node WWN
3      Delete member based on its Port/Node WWN
select : (0..3) [1] 0
done ...
```

## Adding a member to the ACL

1. Connect to the switch and log in using an account assigned to the admin role.
2. Enter the **msConfigure** command.  
The command becomes interactive.
3. At the “select” prompt, enter **2** to add a member based on its port/node WWN.
4. At the “Port/Node WWN” prompt, enter the WWN of the host to be added to the ACL.
5. At the “select” prompt, enter **1** to display the access list so you can verify that the WWN you entered was added to the ACL.
6. After verifying that the WWN was added correctly, enter **0** at the prompt to end the session.
7. At the “Update the FLASH?” prompt, enter **y**.
8. Press **Enter** to update the nonvolatile memory and end the session.

### Example of adding a member to the management server ACL

```
switch:admin> msconfigure
0      Done
1      Display the access list
2      Add member based on its Port/Node WWN
3      Delete member based on its Port/Node WWN
select : (0..3) [1] 2
```

```

Port/Node WWN (in hex): [00:00:00:00:00:00:00:00] 20:00:00:20:37:65:ce:aa
*WWN is successfully added to the MS ACL.
0      Done
1      Display the access list
2      Add member based on its Port/Node WWN
3      Delete member based on its Port/Node WWN
select : (0..3) [2] 1
MS Access List consists of (14): {
  20:00:00:20:37:65:ce:aa
  20:00:00:20:37:65:ce:bb
  20:00:00:20:37:65:ce:ff
  20:00:00:20:37:65:ce:11
  20:00:00:20:37:65:ce:22
  20:00:00:20:37:65:ce:33
  20:00:00:20:37:65:ce:44
  10:00:00:60:69:04:11:24
  10:00:00:60:69:04:11:23
  21:00:00:e0:8b:04:70:3b
  10:00:00:60:69:04:11:33
  20:00:00:20:37:65:ce:55
  20:00:00:20:37:65:ce:66
  00:00:00:00:00:00:00:00
}
0      Done
1      Display the access list
2      Add member based on its Port/Node WWN
3      Delete member based on its Port/Node WWN
select : (0..3) [1] 0
done ...
Update the FLASH? (yes, y, no, n): [yes] y
*Successfully saved the MS ACL to the flash.

```

## Deleting a member from the ACL

1. Connect to the switch and log in as admin.
2. Enter the **msConfigure** command.  
The command becomes interactive.
3. At the “select” prompt, enter **3** to delete a member based on its port/node WWN.
4. At the “Port/Node WWN” prompt, enter the WWN of the member to be deleted from the ACL.
5. At the “select” prompt, enter **1** to display the access list so you can verify that the WWN you entered was deleted from the ACL.
6. After verifying that the WWN was deleted correctly, enter **0** at the “select” prompt to end the session.
7. At the “Update the FLASH?” prompt, enter **y**.
8. Press **Enter** to update the nonvolatile memory and end the session.

### Example of deleting a member from the management server ACL

```

switch:admin> msconfigure

0      Done
1      Display the access list
2      Add member based on its Port/Node WWN

```

# 1 Management server database

```
3          Delete member based on its Port/Node WWN
select : (0..3) [1] 3

Port/Node WWN (in hex): [00:00:00:00:00:00:00:00] 10:00:00:00:c9:29:b3:84
*WWN is successfully deleted from the MS ACL.
0          Done
1          Display the access list
2          Add member based on its Port/Node WWN
3          Delete member based on its Port/Node WWN
select : (0..3) [3] 1

MS Access list is empty

0          Done
1          Display the access list
2          Add member based on its Port/Node WWN
3          Delete member based on its Port/Node WWN
select : (0..3) [1] 0
```

## Viewing the contents of the management server database

1. Connect to the switch and log in using an account assigned to the admin role.
2. Enter the **msPlatShow** command.

### Example of viewing the contents of the management server platform database

```
switch:admin> msplatshow
-----
Platform Name: [9] "first obj"
Platform Type: 5 : GATEWAY
Number of Associated M.A.: 1
[35] "http://java.sun.com/products/plugin"
Number of Associated Node Names: 1
Associated Node Names:
10:00:00:60:69:20:15:71
-----
Platform Name: [10] "second obj"
Platform Type: 7 : HOST_BUS_ADAPTER
Number of Associated M.A.: 1
Associated Management Addresses:
[30] "http://java.sun.com/products/1"
Number of Associated Node Names: 1
Associated Node Names:
10:00:00:60:69:20:15:75
```

## Clearing the management server database

---

### NOTE

The command **msPIClearDB** is allowed only in ADO and AD255.

---

1. Connect to the switch and log in using an account assigned to the admin role.
2. Enter the **mspiClearDb** command.
3. Enter **y** to confirm the deletion.

The management server platform database is cleared.



# Topology discovery

The topology discovery feature can be displayed, enabled, and disabled; it is disabled by default. The commands **mstdEnable** and **mstdDisable** are allowed only in ADO and AD255.

## Displaying topology discovery status

1. Connect to the switch and log in as admin.
2. Enter the **mstdReadConfig** command.

```
switch:admin> mstdreadconfig
*MS Topology Discovery is Enabled.
```

## Enabling topology discovery

1. Connect to the switch and log in as admin.
2. Enter the appropriate following command based on how you want to enable discovery:
  - For the local switch, enter the **mstdEnable** command.
  - For the entire fabric, enter the **mstdEnable all** command.

### Example of enabling discovery

```
switch:admin> mstdenable

Request to enable MS Topology Discovery Service in progress....
*MS Topology Discovery enabled locally.

switch:admin> mstdenable ALL

Request to enable MS Topology Discovery Service in progress....
*MS Topology Discovery enabled locally.
*MS Topology Discovery Enable Operation Complete!!
```

## Disabling topology discovery

1. Connect to the switch and log in as admin.
2. Enter the appropriate following command based on how you want to disable discovery:
  - For the local switch, enter the **mstdDisable** command.
  - For the entire fabric, enter the **mstdDisable all** command.A warning displays that all NID entries might be cleared.
3. Enter **y** to disable the Topology Discovery feature.

---

### NOTE

Disabling discovery of management server topology might erase all node ID entries.

---

### Example of disabling discovery

```
switch:admin> mstddisable
This may erase all NID entries. Are you sure? (yes, y, no, n): [no] y

Request to disable MS Topology Discovery Service in progress....
```

# 1 Device login

```
*MS Topology Discovery disabled locally.  
  
switch:admin> mstdisable all  
This may erase all NID entries. Are you sure? (yes, y, no, n): [no] y  
  
Request to disable MS Topology Discovery Service in progress....  
*MS Topology Discovery disabled locally.  
*MS Topology Discovery Disable Operation Complete!!
```

## Device login

A device can be a storage, host, or switch. When new devices are introduced into the fabric, they must be powered on and, if a host or storage device, connected to a switch. The switch must be connected to another switch. E\_Ports exchange different frames than the ones listed below with the Fabric Controller to access the fabric. Once storage and host devices are powered on and connected, the following logins occur:

1. FLOGI—Fabric Login command establishes a 24-bit address for the device logging in, and establishes buffer-to-buffer credits and the class of service supported.
2. PLOGI—Port Login command logs the device into the Name Server to register its information as well as query for devices that share its zone. During the PLOGI process, information is exchanged between the new device and the fabric. A few of the following types of information exchanges occur:
  - SCR—State Change Registration registers the device for State Change Notifications. If there is a change in the fabric, such as a zoning change or a change in the state of a device to which this device has access, the device will receive a Registered State Change Notification (RSCN).
  - Registration—A device exchanges registration information with the Name Server.
  - Query—Devices query the Name Server for information about the device it can access.

## Principal switch

In a fabric with multiple switches, and one inter-switch link (ISL) exists between any two switches, a principal switch is automatically elected. The principal switch provides the following capabilities:

- Maintains time for the entire fabric. Subordinate switches synchronize their time with the principal switch. Changes to the clock server value on the principal switch are propagated to all switches in the fabric.
- Manages domain ID assignment within the fabric. If a switch requests a domain ID that has been used before, the principal switch grants the same domain ID unless it is in use by another switch.

## E\_Port login

An E\_Port does not use a FLOGI to log in to another switch. Instead, the new switch exchanges frames with the principal switch to establish that the new switch is an E\_Port and that it has information to exchange. If everything is acceptable to the principal switch, it replies to the new switch with an SW\_ACC (accept) frame. The initializing frame is an Exchange Link Parameters (ELP) frame that allows an exchange of parameters between two ports, such as flow control, buffer-to-buffer credits, RA\_TOV, and ED\_TOV. This is not a negotiation. If one or the other port's link

parameters do not match, a link will not occur. Once an SW\_ACC frame is received from the principal switch, the new switch sends an Exchange Switch Capabilities (ESC) frame. The two switches exchange routing protocols and agree on a common routing protocol. An SW\_ACC frame is received from the principal switch and the new switch sends an Exchange Fabric Parameters (EFP) frame to the principal switch, requesting principal switch priority and the domain ID list. Buffer-to-buffer credits for the device and switch ports are exchanged in the SW\_ACC command sent to the device in response to the FLOGI.

## Fabric login

A device performs a fabric login (FLOGI) to determine if a fabric is present. If a fabric is detected then it exchanges service parameters with the fabric controller. A successful FLOGI sends back the 24-bit address for the device in the fabric. The device must issue and successfully complete a FLOGI command before communicating with other devices in the fabric.

Because the device does not know its 24-bit address until after the FLOGI, the source ID (SID) in the frame header making the FLOGI request will be zeros (0x000000).

## Port login process

The steps in the port initialization process represent a protocol used to discover the type of device connected and establish the port type and negotiate port speed.

The possible port types are as follows:

- U\_Port — A universal FC port is the base Fibre Channel port type, and all unidentified or uninitiated ports are listed as U\_Ports.
- L\_/FL\_Port — A loop or fabric loop port connects loop devices. L\_Ports are associated with private loop devices and FL\_Ports are associated with public loop devices.
- G\_Port — A generic port acts as a transition port for non-loop fabric-capable devices.
- E\_Port — An expansion port is assigned to ISL links to expand your fabric by connecting it to other switches.
- F\_Port — A fabric port is assigned to fabric-capable devices, such as SAN storage devices.
- EX\_Port — A type of E\_Port that connects a Fibre Channel router to an edge fabric. From the point of view of a switch in an edge fabric, an EX\_Port appears as a normal E\_Port. It follows applicable Fibre Channel standards as other E\_Ports. However, the router terminates EX\_Ports rather than allowing different fabrics to merge as would happen on a switch with regular E\_Ports.
- Mirror Port — A mirror port is a configured switch port that connects to a port to mirror a specific source port and destination port traffic passing through any switch port. This is only supported between F\_Ports.
- VE\_Port — A virtual E\_Port is a gigabit Ethernet switch port configured for an FCIP tunnel. However, with a VEX\_Port at the other end, it does not propagate fabric services or routing topology information from one edge fabric to another.
- VEX\_Port — A virtual EX\_Port connects a Fibre Channel router to an edge fabric. From the point of view of a switch in an edge fabric, a VEX\_Port appears as a normal VE\_Port. It follows the same Fibre Channel protocol as other VE\_Ports. However, the router terminates VEX\_Ports rather than allowing different fabrics to merge as would happen on a switch with regular VE\_Ports.

# 1 High availability of daemon processes

The Fibre Channel protocol (FCP) auto discovery process enables private storage devices that accept the process login (PRLI) to communicate in a fabric.

If device probing is enabled, the embedded performs a PLOGI and attempts a PRLI into the device to retrieve information to enter into the Name Server. This enables private devices that do not perform a FLOGI, but accept a PRLI, to be entered in the Name Server and receive full fabric access.

A fabric-capable device registers its information with the Name Server during a FLOGI. These devices typically register information with the Name Server before querying for a device list. The embedded port still performs a PLOGI and attempts a PRLI with these devices.

If a port decides to end the current session, it initiates a logout. A logout concludes the session and terminates any work in progress associated with that session.

To display the contents of a switch's Name Server, use the **nsShow** or **nsAllShow** command. For more information about these Name Server commands, refer to the *Fabric OS Command Reference*.

## RSCN causes

An Registered State Change Notification (RSCN) is a notification frame that is sent to devices that are zoned together and are registered to receive a State Change Notification (SCN). The RSCN is responsible for notifying all devices of fabric changes. The following general list of actions can cause an RSCN to be sent through your fabric:

- A new device has been added to the fabric.
- An existing device has been removed from the fabric.
- A zone has changed.
- A switch name has changed or an IP address has changed.
- Nodes leaving or joining the fabric, such as zoning or powering on or shutting down a device, or zoning changes.

---

### NOTE

Fabric reconfigurations with no domain change will not cause an RSCN.

---

## High availability of daemon processes

Starting non-critical daemons is automatic; you cannot configure the startup process. The following sequence of events occurs when a non-critical daemon fails:

1. A RASlog and AUDIT event message is logged.
2. The daemon is automatically started again.
3. If the restart is successful, then another message is sent to RASlog and AUDIT, reporting the successful restart status.
4. If the restart fails, another message is sent to RASlog and no further attempts are made to restart the daemon.

Schedule downtime and reboot the switch at your convenience. [Table 1](#) lists the daemons that are considered non-critical and are automatically restarted on failure.

**TABLE 1** Daemons that are automatically restarted

Daemon	Description
arrd	Asynchronous Response Router, which is used to send management data to hosts when the switch is accessed through the APIs (FA API or SMI-S).
cald	Common Access Layer daemon, which is used by manageability applications.
raslogd	Reliability, Availability, and Supportability daemon logs error detection, reporting, handling, and presentation of data into a format readable by you and management tools.
rpcd	Remote Procedure Call daemon, used by the API (Fabric Access API and SMI-S).
snmpd	Simple Network Management Protocol daemon.
traced	Trace daemon provides trace entry date/time translation to Trace Device at startup and when date/time changed by command. Maintains the trace dump trigger parameters in a Trace Device. Performs the trace Background Dump, trace automatic FTP, and FTP "aliveness check" if auto-FTP is enabled.
trafd	Traffic daemon implements Bottleneck detection.
webd	Webserver daemon used for WebTools (includes httpd as well).
weblinkerd	Weblinker daemon provides an HTTP interface to manageability applications for switch management and fabric discovery.

# 1 High availability of daemon processes

# Performing Basic Configuration Tasks

---

## In this chapter

• Fabric OS overview .....	15
• Fabric OS command line interface .....	16
• Password modification .....	18
• The Ethernet interface on your switch .....	20
• Date and time settings .....	25
• Domain IDs .....	28
• Switch names .....	30
• Chassis names .....	31
• Switch activation and deactivation .....	31
• Switch and enterprise-class platform shutdown .....	31
• Basic connections .....	33

## Fabric OS overview

This chapter describes how to configure your Brocade SAN using the Fabric OS command line interface (CLI). Before you can configure a storage area network (SAN), you must power up the enterprise-class platform or switch and blades, and then set the IP addresses of those devices. Although this chapter focuses on configuring a SAN using the CLI, you can also use the following methods to configure a SAN:

- Web Tools  
For Web Tools procedures, see the *Web Tools Administrator's Guide*.
- Data Center Fabric Manager (DCFM)  
For DCFM procedures, see the *Data Center Fabric Manager Professional User Manual* or *Data Center Fabric Manager Enterprise User Manual* depending on the version you have.
- A third-party application using the API  
For third-party application procedures, refer to the third-party API documentation.

Because of the differences between fixed-port and variable-port devices, procedures sometimes differ among Brocade models. As new Brocade models are introduced, new features sometimes apply only to those models.

When procedures or parts of procedures apply to some models but not others, this guide identifies the specifics for each model. For example, a number of procedures that apply only to variable-port devices are found in [“Performing Advanced Configuration Tasks”](#) on page 35.

Although many different software and hardware configurations are tested and supported by Brocade Communications Systems, Inc., documenting all possible configurations and scenarios is beyond the scope of this document. In some cases, earlier releases are highlighted to present considerations for interoperating with them.

The hardware reference manuals for Brocade products describe how to power up devices and set their IP addresses. After the IP address is set, you can use the CLI procedures contained in this guide. For additional information about the commands used in the procedures, see online help or the *Fabric OS Command Reference*.

## Fabric OS command line interface

Fabric OS uses Role-Based Access Control (RBAC) to control access to all Fabric OS operations. Each feature is associated with an RBAC role and you will need to know which role is allowed to run a command, make modifications to the switch, or view the output of the command. To determine which RBAC role you need to run a command, review the section [“Role-Based Access Control \(RBAC\)”](#) on page 84.

---

### NOTE

When command examples in this guide show user input enclosed in quotation marks, the quotation marks are required.

---

## Console sessions using the serial port

Note the following behaviors for serial connections:

- Some procedures require that you connect through the serial port; for example, setting the IP address or setting the boot PROM password.
- **Brocade 48000 director and Brocade DCX and DCX-4S enterprise-class platforms:** You can connect to CP0 or CP1 using either of the two serial ports.

### *Connecting to Fabric OS through the serial port*

1. Connect the serial cable to the serial port on the switch and to an RS-232 serial port on the workstation.

If the serial port on the workstation is RJ-45 instead of RS-232, remove the adapter on the end of the serial cable and insert the exposed RJ-45 connector into the RJ-45 serial port on the workstation.

2. Open a terminal emulator application (such as HyperTerminal on a PC, TERM, TIP, or Kermit in a UNIX environment), and configure the application as follows:

- In a Windows environment enter the following parameters:

Parameter	Value
Bits per second	9600
Databits	8
Parity	None
Stop bits	1
Flow control	None



- In a UNIX environment, enter the following string at the prompt:

```
tip /dev/ttyb -9600
```

If **ttyb** is already in use, use **ttya** instead and enter the following string at the prompt:

```
tip /dev/ttya -9600
```

## Telnet or SSH sessions

Connect to the Fabric OS through a Telnet or SSH connection or through a console session on the serial port. The switch must also be physically connected to the network. If the switch network interface is not configured or the switch has been disconnected from the network, use a console session on the serial port as described in [“Console sessions using the serial port”](#) on page 16.

---

### NOTE

To automatically configure the network interface on a DHCP-enabled switch, plug the switch into the network and power it on. The DHCP client automatically gets the IP and gateway addresses from the DHCP server. The DHCP server must be on the same subnet as the switch. See [“DHCP activation”](#) on page 23 for more details.

---

### *Rules for Telnet connections*

The following rules should be observed when making Telnet connections to your switch:

- Never change the IP address of the switch while two Telnet sessions are active; if you do, your next attempt to log in fails. To recover, gain access to the switch by one of these methods:
  - You can use Web Tools to perform a fast boot. When the switch comes up, the Telnet quota is cleared. (For instructions on performing a fast boot with Web Tools, see the *Web Tools Administrator's Guide*.)
  - If you have the required privileges, you can connect through the serial port, log in as admin, and use the **killTelnet** command to identify and kill the Telnet processes without disrupting the fabric.
- For accounts with an admin role, Fabric OS limits the number of simultaneous Telnet sessions per switch to two. For more details on session limits, refer to [“Managing User Accounts”](#) on page 83.

### *Connecting to Fabric OS using Telnet*

1. Connect through a serial port to the switch that is appropriate for your fabric:
  - If Virtual Fabrics is enabled, then log in using an admin account assigned the chassis-role permission.
  - If Virtual Fabrics is not enabled, then log in using an account assigned to the admin role.
2. Verify the switch's network interface is configured and that it is connected to the IP network through the RJ-45 Ethernet port.

Switches in the fabric that are not connected through the Ethernet port can be managed through switches that are using IP over Fibre Channel. The embedded port must have an assigned IP address.
3. Log off the switch's serial port.

4. From a management station, open a Telnet connection using the IP address of the switch to which you want to connect.

The login prompt is displayed when the Telnet connection finds the switch in the network.

5. Enter the account ID at the login prompt.

See [“Password modification”](#) on page 18 for instructions on how to log in for the first time.

6. Enter the password.

If you have not changed the system passwords from the default, you are prompted to change them. Enter the new system passwords, or press **Ctrl+C** to skip the password prompts. For more information on system passwords, refer to [“Default account passwords”](#) on page 19.

7. Verify the login was successful.

The prompt displays the switch name and user ID to which you are connected.

```
login: admin
password: xxxxxxxx
```

### Getting help on a command

You can display a list of all command help topics for a given login level. For example, if you are logged in as user and enter the **help** command, a list of all user-level commands that can be executed is displayed. The same rule applies to the admin, securityAdmin, and the switchAdmin roles.

1. Connect to the switch and log in using an account assigned to the admin role.
2. Enter the **help [ |more]** command with no specific command and all commands will be displayed.

The **|more** argument displays the commands one page at a time.

Or you can enter **help <command> |more**, where *command* is the name of the command for which you need specific information.

The following commands provide help files for the indicated specific topics:

diagHelp	Diagnostic help information
ficonHelp	FICON help information
fwHelp	Fabric Watch help information
iscsiHelp	iSCSI help information
licenseHelp	License help information
perfHelp	Performance Monitoring help information
routeHelp	Routing help information
trackChangesHelp	Track Changes help information
zoneHelp	Zoning help information

## Password modification

The switch automatically prompts you to change the default account passwords after logging in for the first time. If you do not change the passwords, the switch prompts you after each subsequent login until all the default passwords have been changed.

**NOTE**

The default account passwords can be changed from their original value only when prompted immediately following the login; the passwords cannot be changed using the `passwd` command later in the session. If you skip the prompt, and then later decide to change the passwords, log out and then back in.

The default accounts on the switch are admin, user, root, and factory. Use the default administrative account as shown in [Table 2](#) to log in to the switch for the first time and to perform the basic configuration tasks.

There is only one set of default accounts for the entire chassis. The root and factory default accounts are reserved for development and manufacturing. The user account is primarily used for system monitoring. For more information on default accounts, see “[Default accounts](#)” on page 88.

[Table 2](#) describes the default administrative accounts for switches by model number.

**TABLE 2** Default administrative account names and passwords

Model	Administrative account	Password
Brocade 300, 4100, 4900, 5000, 5410, 5424, 5450, 5460, 5470, 5480, 5100, 5300, 5424, 7500, 7500E, 7600, 7800, 8000, and VA50-FC switches	admin	password
Brocade 48000 director and Brocade DCX and DCX-4S enterprise-class platforms	admin	password

## Default account passwords

The change default account passwords prompt is a string that starts with **Please change your passwords now**. User-defined passwords can have 8 to 40 characters. They must begin with an alphabetic character and can include numeric characters, the period (.), and the underscore (\_). They are case-sensitive, and they are not displayed when you enter them on the command line.

Record the passwords exactly as entered and store them in a secure place because recovering passwords requires significant effort and fabric downtime. Although the root and factory accounts are not meant for general use, change their passwords if prompted to do so and save the passwords in case they are needed for recovery purposes.

### *Changing the default account passwords at login*

1. Connect to the switch and log in using the default administrative account.
2. At each of the “Enter new password” prompts, either enter a new password or skip the prompt.

To skip a single prompt press **Enter**. To skip all of the remaining prompts press **Ctrl-C**.

#### Example output of changing passwords

```
login: admin
Password:
Please change your passwords now.
Use Control-C to exit or press 'Enter' key to proceed.
for user - root
Changing password for root
Enter new password: <hidden>
Password changed.
Saving password to stable storage.
Password saved to stable storage successfully.
(output truncated)
```

## The Ethernet interface on your switch

The Ethernet (network) interface provides management access, including direct access to the Fabric OS CLI, and allows other tools, such as Web Tools, to interact with the switch. You can use either Dynamic Host Configuration Protocol (DHCP) or static IP addresses for the Ethernet network interface configuration. On Brocade enterprise-class platforms you must set IP addresses for the following components:

- Both CPs (CP0 and CP1)
- Chassis management IP

On the Brocade switches, you must set the Ethernet and chassis management IP interfaces.

Setting the chassis management IP eliminates the need to know which CP is active and connects to the currently active CP.

You can continue to use a static Ethernet addressing system or allow the DHCP client to automatically acquire Ethernet addresses. Configure the Ethernet interface IP address, subnet mask, and gateway addresses in one of the following manners:

- [“Static Ethernet addresses”](#) on page 22
- [“DHCP activation”](#) on page 23

---

### NOTE

When you change the Ethernet interface settings, open connections such as SSH or Telnet may be dropped. Reconnect using the new Ethernet IP address information or change the Ethernet settings using a console session through the serial port to maintain your session through the change. You must connect through the serial port to set the Ethernet IP address if the Ethernet network interface is not configured already. Refer [“Connecting to Fabric OS through the serial port”](#) on page 16 for details.

---

## Virtual Fabrics and the Ethernet interface

On the Brocade 48000, DCX, and DCX-4S, the single-chassis IP address and subnet mask are assigned to the management Ethernet ports on the front panels of the CPs. These addresses allow access to the chassis, more specifically the active CP of the chassis, and not individual logical switches. The IP addresses can also be assigned to each CP individually. This allows for direct communication with a CP including the standby CP. On the Brocade DCX and DCX-4S Backbones, each CP has two management Ethernet ports on its front panel. These two physical ports are bonded together to create a single, logical Ethernet port, and it is the logical Ethernet port to which IP addresses are assigned.

IPv4 addresses assigned to individual Virtual Fabrics are assigned to IP-over-FC network interfaces. In Virtual Fabrics environment, a single chassis can be assigned to multiple fabrics, each of which is logically distinct and separate from one another. Each IP-over-FC (IPFC) point of connection to a given chassis needs a separate IPv4 address and prefix to be accessible to a management host. For more information on how to set up these IPFC addresses to your Virtual Fabric, refer to [Chapter 10, “Managing Virtual Fabrics”](#).

## Displaying the network interface settings

If an IP address has not been assigned to the network interface (Ethernet), you must connect to the Fabric OS CLI using a console session on the serial port. For more information, see [“Console sessions using the serial port”](#) on page 16. Otherwise, connect using SSH.

1. Connect to the switch and log in using an account assigned to the admin role.
2. Enter the **ipAddrShow** command.

### Example output of an enterprise-class platform.

```
eCP:admin> ipaddrshow
SWITCH
Ethernet IP Address: 10.1.2.3
Ethernet Subnetmask: 255.255.240.0

CP0
Ethernet IP Address: 10.1.2.3
Ethernet Subnetmask: 255.255.240.0
Host Name: ecp0
Gateway IP Address: 10.1.2.1

CP1
Ethernet IP Address: 10.1.2.4
Ethernet Subnetmask: 255.255.240.0
Host Name: ecp1
Gateway IP Address: 10.1.2.3

IPFC address for virtual fabric ID 123: 11.1.2.3/24
IPFC address for virtual fabric ID 45: 13.1.2.4/20

Slot 7
eth0: 11.1.2.4/24
Gateway: 11.1.2.1

Backplane IP address of CP0 : 10.0.0.5
Backplane IP address of CP1 : 10.0.0.6

IPv6 Autoconfiguration Enabled: Yes
Local IPv6 Addresses:
sw 0 stateless fd00:60:69bc:70:260:69ff:fe00:2/64 preferred
sw 0 stateless fec0:60:69bc:70:260:69ff:fe00:2/64 preferred
cp 0 stateless fd00:60:69bc:70:260:69ff:fe00:197/64 preferred
cp 0 stateless fec0:60:69bc:70:260:69ff:fe00:197/64 preferred
cp 1 stateless fd00:60:69bc:70:260:69ff:fe00:196/64 preferred
cp 1 stateless fec0:60:69bc:70:260:69ff:fe00:196/64 preferred
IPv6 Gateways:
cp 0 fe80:60:69bc:70::3
cp 0 fe80:60:69bc:70::2
cp 0 fe80:60:69bc:70::1
cp 1 fe80:60:69bc:70::3
```

If the Ethernet IP address, subnet mask, and gateway address are displayed, then the network interface is configured. Verify the information on your switch is correct. If DHCP is enabled, the network interface information was acquired from the DHCP server.

---

### NOTE

You can use either IPv4 or IPv6 with a classless inter-domain routing (CIDR) block notation (also known as a network prefix length) to set up your IP addresses.

---

### Static Ethernet addresses

Use static Ethernet network interface addresses on Brocade 48000 directors and Brocade DCX and DCX-4S enterprise-class platforms, and in environments where DHCP service is not available. To use static addresses for the Ethernet interface, you must first disable DHCP. You can enter static Ethernet information and disable DHCP at the same time. Refer to “[DHCP activation](#)” on page 23 for more information.

If you choose not to use DHCP or to specify an IP address for your switch Ethernet interface, you can do so by entering **none** or **0.0.0.0** in the Ethernet IP address field.

On an application blade, configure the two external Ethernet interfaces to two different subnets. If two subnets are not present, configure one of the interfaces and leave the other unconfigured. Otherwise, the following message will display and blade status may go into a faulty state after a reboot.

```
Neighbor table overflow.  
print: 54 messages suppressed
```

### *Setting the static addresses for the Ethernet network interface*

1. Connect to the switch and log in using an account assigned to the admin role.
2. Perform the appropriate action based on whether you have a switch or enterprise-class platform:
  - If you are setting the IP address for a switch, enter the **ipAddrSet** command.
  - If you are setting the IP address for an enterprise-class platform, enter the **ipAddrSet** command specifying either CPO or CP1. You must set the IP address for both CPO and CP1.

#### **Example of setting the IPv4 address**

```
switch:admin> ipaddrset  
Ethernet IP Address [10.1.2.3]:  
Ethernet Subnetmask [255.255.255.0]:  
Fibre Channel IP Address [220.220.220.2]:  
Fibre Channel Subnetmask [255.255.0.0]:  
Gateway IP Address [10.1.2.1]:  
DHCP [OFF]: off
```

#### **Example of setting an IPv6 address on a switch**

```
switch:admin> ipaddrset -ipv6 --add 1080::8:800:200C:417A/64  
IP address is being changed...Done.
```

For more information on setting up an IP address for a Virtual Fabric, refer to [Chapter 10](#), “[Managing Virtual Fabrics](#)”.

3. Enter the network information in dotted-decimal notation for the Ethernet IPv4 address and in semicolon-separated notation for IPv6.
4. Enter the **Ethernet Subnetmask** at the prompt.
5. Skip Fibre Channel prompts by pressing **Enter**.  
The Fibre Channel IP address is used for management.
6. Enter the **Gateway Address** at the prompt.
7. Disable DHCP by entering **off**.

### *Setting the static addresses for the chassis IP management interface*

1. Connect to the switch and log in using an account assigned to the admin role.
2. Enter the **ipAddrSet -chassis** command.

#### **Example of setting the chassis IPv4 address**

```
switch:admin> ipaddrset -chassis
Ethernet IP Address [192.168.166.148]:
Ethernet Subnetmask [255.255.255.0]:
Committing configuration...Done.
```

3. Enter the network information in dotted-decimal notation for the Ethernet IPv4 address and in semicolon-separated notation for IPv6.
4. Enter the **Ethernet Subnetmask** at the prompt.

## DHCP activation

By default, some Brocade switches have DHCP enabled. The Brocade 48000 director and Brocade DCX and Brocade DCX-4S enterprise-class platforms do not support DHCP.

The Fabric OS DHCP client supports the following parameters:

- External Ethernet port IP addresses and subnet masks
- Default gateway IP address

The DHCP client uses a DHCP vendor class identifier that allows DHCP servers to determine that the Discovers and Requests are coming from a Brocade switch. The vendor class identifier is the string “BROCADE” followed by the SWBD model number of the platform. For example, the vendor class identifier for a request from a Brocade 5300 is “BROCADESWBD64.”

---

#### **NOTE**

The client conforms to the latest IETF Draft Standard RFCs for IPv4, IPv6, and DHCP.

---

### *Enabling DHCP*

Connect the DHCP-enabled switch to the network, power on the switch, and the switch automatically obtains the Ethernet IP address, Ethernet subnet mask, and default gateway address from the DHCP server. The DHCP client can only connect to a DHCP server on the same subnet as the switch. Do not enable DHCP if the DHCP server is not on the same subnet as the switch.

Enabling DHCP after the Ethernet information has been configured releases the current Ethernet network interface settings, including Ethernet IP Address, Ethernet Subnetmask, and Gateway IP Address. The Fibre Channel (FC) IP address and subnet mask are static and are not affected by DHCP; see “[Static Ethernet addresses](#)” on page 22 for instructions on setting the FC IP address.

1. Connect to the switch and log in using an account assigned to the admin role.
2. Enter the **ipAddrSet** command.
3. If already set up, skip the Ethernet IP address, Ethernet subnet mask, Fibre Channel IP address and subnet mask prompts by pressing **Enter**.
4. When you are prompted for DHCP[Off], enable it by entering **on**.

## 2 The Ethernet interface on your switch

### Example of enabling DHCP

```
switch:admin> ipaddrset
Ethernet IP Address [10.1.2.3]:
Ethernet Subnetmask [255.255.255.0]:
Fibre Channel IP Address [220.220.220.2]:
Fibre Channel Subnetmask [255.255.0.0]:
Gateway IP Address [10.1.2.1]:
DHCP [Off]:on
```

### *Disabling DHCP*

When you disable DHCP, enter the static Ethernet IP address and subnet mask of the switch and default gateway address. Otherwise, the Ethernet settings may conflict with other addresses assigned by the DHCP server on the network.

1. Connect to the switch and log in using an account assigned to the admin role.
2. Enter the **ipAddrSet** command.
3. Enter the network information in dotted-decimal notation for the Ethernet IPv4 address and in semicolon-separated notation for IPv6.

If a static Ethernet address is not available when you disable DHCP, enter **0.0.0.0** at the Ethernet IP address prompt.

4. Skip Fibre Channel prompts by pressing **Enter**.
5. When you are prompted for DHCP[On], disable it by entering **off**.

### Example of disabling DHCP

```
switch:admin> ipaddrset
Ethernet IP Address [10.1.2.3]:
Ethernet Subnetmask [255.255.255.0]:
Fibre Channel IP Address [220.220.220.2]:
Fibre Channel Subnetmask [255.255.0.0]:
Gateway IP Address [10.1.2.1]:
DHCP [On]:off
```

## IPv6 autoconfiguration

IPv6 can assign multiple IP addresses to each network interface. Each interface is configured with a link local address in almost all cases, but this address is only accessible from other hosts on the same network. To provide for wider accessibility, interfaces are typically configured with at least one additional global scope IPv6 address. IPv6 autoconfiguration allows more IPv6 addresses, the number of which is dependent on the number of routers serving the local network and the number of prefixes they advertise.

---

### NOTE

An upgrade from Fabric OS v6.1.0 or earlier, which does not support IPv6 autoconfiguration, to a platform that does support IPv6 autoconfiguration, such as Fabric OS v6.2.0 or later, will cause IPv6 autoconfiguration to be enabled on the upgraded platform. In upgrades or downgrades between versions of Fabric OS that support autoconfiguration, the enabled state of IPv6 autoconfiguration will not be changed.

---



There are two methods of autoconfiguration for IPv6 addresses, stateless and stateful. *Stateless* allows an IPv6 host to obtain a unique address using the IEEE 802 MAC address; *stateful* uses a DHCPv6 server which keeps a record of the IP address and other configuration information for the host. Whether a host engages in autoconfiguration and which method it uses is dictated by the routers serving the local network, not by a configuration of the host. There can be multiple routers serving the network, each potentially advertising multiple network prefixes. Thus the host is not in full control of the number of IPv6 addresses that it configures, much less the values of those addresses, and the number and values of addresses can change as routers are added to or removed from the network.

When IPv6 autoconfiguration is enabled, the platform will engage in stateless IPv6 autoconfiguration. When IPv6 autoconfiguration is disabled, the platform will relinquish usage of any autoconfigured IPv6 addresses that it may have acquired while it was enabled. This same enable and disable state also enables or disables the usage of a link local address for each managed entity, though a link local address will continue to be generated for each nonchassis-based platform and for each CP of a chassis-based platform because those link local addresses are required for router discovery. The enabled or disabled state of autoconfiguration is independent of whether any static IPv6 addresses have been configured.

### *Setting IPv6 autoconfiguration*

1. Connect to the switch and log in using an account assigned to the admin role.
2. Take the appropriate following action based on whether you want to enable or disable IPv6 autoconfiguration:
  - Enter the `ipAddrSet -ipv6 -auto` command to enable IPv6 autoconfiguration for all managed entities on the target platform.
  - Enter the `ipAddrSet -ipv6 -noauto` command to disable IPv6 autoconfiguration for all managed entities on the target platform.

## Date and time settings

Switches maintain the current date and time inside a battery-backed real-time clock (RTC) circuit that receives the date and time from the fabric's principal switch. Date and time are used for logging events. Switch operation does not depend on the date and time; a switch with an incorrect date and time value still functions properly. However, because the date and time are used for logging, error detection, and troubleshooting, you should set them correctly.

In a Virtual Fabric, there can be a maximum of eight logical switches per director or enterprise-class platform. Only the default switch in the chassis will update the hardware clock. When the `date` command is issued from a non-principal pre-Fabric OS v6.2.0 switch, the `date` command request is dropped by a Fabric OS v6.2.0 and later switch and the pre-Fabric OS v6.2.0 switch will not receive an error.

Authorization access to set or change the date and time for a switch is role-based. For an understanding of role-based access, refer to [“Role-Based Access Control \(RBAC\)”](#) on page 84.

### Setting the date and time

1. Connect to the switch and log in using an account assigned to the admin role.
2. Enter the `date` command, using the following syntax:

## 2 Date and time settings

```
date "mmddHHMMyy"
```

The values represent the following:

- mm is the month; valid values are 01 through 12.
- dd is the date; valid values are 01 through 31.
- HH is the hour; valid values are 00 through 23.
- MM is minutes; valid values are 00 through 59.
- yy is the year, valid values are 00-37 and 70-99 (year values from 70-99 are interpreted as 1970-1999, year values from 00-37 are interpreted as 2000-2037).

### Example of showing and setting the date

```
switch:admin> date
Fri Sep 29 17:01:48 UTC 2007
Stealth200E:admin> date "0204101008"
Mon Feb 4 10:10:00 UTC 2008
```

## Time zone settings

You can set the time zone for a switch by name. You can specify the setting using country and city or time zone parameters. Switch operation does not depend on a date and time setting. However, having an accurate time setting is needed for accurate logging and audit tracking.

If the time zone is not set with new options, the switch retains the offset time zone settings. The **tsTimeZone** command includes an option to revert to the prior time zone format. For more information about the **tsTimeZone** command, refer to the *Fabric OS Command Reference*.

When you set the time zone for a switch, you can perform the following tasks:

- Display all of the time zones supported in the firmware.
- Set the time zone based on a country and city combination or based on a time zone ID, such as PST.

The time zone setting has the following characteristics:

- Users can view the time zone settings. However, only those with administrative permissions can set the time zones.
- The setting automatically adjusts for Daylight Savings Time.
- Changing the time zone on a switch updates the local time zone setup and is reflected in local time calculations.
- By default, all switches are in the GMT time zone (0,0). If all switches in a fabric are in one time zone, it is possible for you to keep the time zone setup at the default setting.
- System services that have already started will reflect the time zone changes only after the next reboot.
- Time zone settings persist across failover for high availability.

Setting the time zone on a dual domain director has the following characteristics:

- Updating the time zone on any switch updates the entire director.
- The time zone of the entire director is the time zone of switch 0.

## *Setting the time zone*

The following procedure describes how to set the time zone for a switch. You must perform the procedure on *all* switches for which the time zone must be set. However, you only need to set the time zone once on each switch because the value is written to nonvolatile memory.

1. Connect to the switch and log in using an account assigned to the admin role and with the chassis-role permission.
2. Enter the **tsTimeZone** command.
  - Use **tsTimeZone** with no parameters to display the current time zone setting.
  - Use **--interactive** to list all of the time zones supported by the firmware.
  - Use **timeZone\_fmt** to set the time zone by Country/City or by time zone ID, such as PST.

### **Example of displaying and changing the time zone to US/Central**

```
switch:admin> tstimezone
Time Zone : US/Pacific
switch:admin> tstimezone US/Central
switch:admin> tstimezone
Time Zone : US/Central
```

## *Setting the time zone interactively*

The following procedure describes how to set the current time zone to Pacific Standard Time using interactive mode.

1. Connect to the switch and log in using an account assigned to the admin role and with the chassis-role permission.
2. Enter the **tsTimeZone --interactive** command.  
You are prompted to select a general location.  

```
Please identify a location so that time zone rules can be set correctly.
```
3. Enter the appropriate **number** or press **Ctrl-D** to quit.
4. At the prompt, select a **country location**.
5. At the prompt, enter the appropriate **number** to specify the time zone region or **Ctrl-D** to quit.

## **Network time protocol**

You can synchronize the local time of the principal or primary fabric configuration server (FCS) switch to a maximum of eight external network time protocol (NTP) servers. To keep the time in your SAN current, it is recommended that the principal or primary-FCS switch has its time synchronized with at least one external NTP server. The other switches in the fabric will automatically take their time from the principal or primary-FCS switch, as described in [“Synchronizing the local time with an external source”](#).

All switches in the fabric maintain the current clock server value in nonvolatile memory. By default, this value is the local clock server <LOCL> of the principal or primary FCS switch. Changes to the clock server value on the principal or primary FCS switch are propagated to all switches in the fabric.

In a Virtual Fabric, all the switches in the fabric must have the same NTP clock server configured. This includes any pre-Fabric OS v6.2.0 switches in the fabric. This ensures that time does not go out of sync in the logical fabric. It is not recommended to have LOCL in the server list.

When a new switch enters the fabric, the time server daemon of the principal or primary FCS switch sends out the addresses of all existing clock servers and the time to the new switch. When a switch with Fabric OS v6.1.0 or later enters the fabric, it stores the list and the active servers.

---

**NOTE**

In a Virtual Fabric, multiple logical switches can share a single chassis. Therefore, the NTP server list must be the same across all fabrics.

---

### *Synchronizing the local time with an external source*

The **tsClockServer** command accepts multiple server addresses in IPv4, IPv6, or DNS name formats. When multiple NTP server addresses are passed, **tsClockServer** sets the first obtainable address as the active NTP server. The rest are stored as backup servers that can take over if the active NTP server fails. The principal or primary FCS switch synchronizes its time with the NTP server every 64 seconds.

1. Connect to the switch and log in using an account assigned to the admin role.
2. Enter the **tsClockServer** command:

```
switch:admin> tsclockserver "<ntp1;ntp2>"
```

In this syntax, *ntp1* is the IP address or DNS name of the first NTP server, which the switch must be able to access. The second variable, *ntp2*, is the second NTP server and is optional. The operand "*<ntp1;ntp2>*" is optional; by default, this value is LOCL, which uses the local clock of the principal or primary switch as the clock server.

#### **Example of setting the NTP server**

```
switch:admin> tsclockserver  
LOCL  
switch:admin> tsclockserver "10.1.2.3"
```

#### **Example of displaying the NTP server**

```
switch:admin> tsclockserver  
10.1.2.3
```

#### **Example of setting up more than one NTP server using a DNS name**

```
switch:admin> tsclockserver "10.1.2.4;10.1.2.5;ntp.localdomain.net"  
Updating Clock Server configuration...done.  
Updated with the NTP servers
```

Changes to the clock server value on the principal or primary FCS switch are propagated to all switches in the fabric.

## Domain IDs

Although domain IDs are assigned dynamically when a switch is enabled, you can change them manually so that you can control the ID number or resolve a domain ID conflict when you merge fabrics.

If a switch has a domain ID when it is enabled, and that domain ID conflicts with another switch in the fabric, the conflict is automatically resolved if the other switch's domain ID is not persistently set. The process can take several seconds, during which time traffic is delayed. If both switches have their domain IDs persistently set, one of them will need to have its domain ID changed to a domain ID not used within the fabric.

The default domain ID for Brocade switches is 1.

---

#### ATTENTION

Do not use domain ID 0. The use of this domain ID can cause the switch to reboot continuously. Avoid changing the domain ID on the FCS in secure mode. To minimize down time, change the domain IDs on the other switches in the fabric.

---

## Displaying the domain IDs

1. Connect to the switch and log in using an account assigned to the admin role.
2. Enter the **fabricShow** command.

#### Example output of fabric information, including the domain ID (D\_ID)

The principal switch is determined by the arrow ( > ) next to the name of the switch. In this output, the principal switch appears in blue and boldface.

```
switch:admin> fabricshow
Switch ID   Worldwide Name           Enet IP Addr   FC IP Addr     Name
-----
  2: fffc02 10:00:00:60:69:e0:01:46 10.3.220.1     0.0.0.0        "ras001"
  3: fffc03 10:00:00:60:69:e0:01:47 10.3.220.2     0.0.0.0        "ras002"
  5: fffc05 10:00:00:05:1e:34:01:bd 10.3.220.5     0.0.0.0        "ras005"
                                fec0:60:69bc:63:205:1eff:fe34:1bd
  6: fffc06 10:00:00:05:1e:34:02:3e 10.3.220.6     0.0.0.0        "ras006"
  7: fffc07 10:00:00:05:1e:34:02:0c 10.3.220.7     0.0.0.0        "ras007"
10: fffc0a 10:00:00:05:1e:39:e4:5a 10.3.220.10    0.0.0.0        "ras010"
15: fffc0f 10:00:00:60:69:80:47:74 10.3.220.15    0.0.0.0        "ras015"
19: fffc13 10:00:00:05:1e:34:00:ad 10.3.220.19    0.0.0.0        "ras019"
                                fec0:60:69bc:63:219:1eff:fe34:1bd
20: fffc14 10:00:00:05:1e:40:68:78 10.3.220.20    0.0.0.0        "ras020"
25: fffc19 10:00:00:05:1e:37:23:c6 10.3.220.25    0.0.0.0        "ras025"
30: fffc1e 10:00:00:60:69:90:04:1e 10.3.220.30    0.0.0.0        "ras030"
35: fffc23 10:00:00:05:1e:07:c7:26 10.3.220.35    0.0.0.0        "ras035"
40: fffc28 10:00:00:60:69:50:06:7f 10.3.220.40    0.0.0.0        "ras040"
45: fffc2d 10:00:00:05:1e:35:10:72 10.3.220.45    0.0.0.0        "ras045"
46: fffc2e 10:00:00:05:1e:34:c5:17 10.3.220.46    0.0.0.0        "ras046"
47: fffc2f 10:00:00:05:1e:02:aa:f7 10.3.220.47    0.0.0.0        >"ras047"
50: fffc32 10:00:00:60:69:c0:06:64 10.1.220.50    0.0.0.0        "ras050"
(output truncated)
```

The Fabric has 26 switches

The fields in the **fabricShow** display are:

Switch ID	The switch's domain_ID and embedded port D_ID. The numbers are broken down as follows: <b>Example 64: fffc40</b> 64 is the switch domain_ID fffc40 is the hexadecimal format of the embedded port D_ID.
Worldwide Name	The switch's WWN.

## 2 Switch names

Enet IP Addr	The switch's Ethernet IP address for IPv4- and IPv6-configured switches. For IPv6 switches, only the static IP address displays.
FC IP Addr	The switch's Fibre Channel IP address.
Name	The switch's symbolic or user-created name in quotes. An arrow (>) indicates the principal switch.

### Setting the domain ID

1. Connect to the switch and log in on an account assigned to the admin role.
2. Enter the **switchDisable** command to disable the switch.
3. Enter the **configure** command.
4. Enter **y** after the **Fabric Parameters** prompt:  

```
Fabric parameters (yes, y, no, n): [no] y
```
5. Enter a unique domain ID at the **Domain** prompt. Use a domain ID value from 1 through 239 for normal operating mode (FCSW-compatible).  

```
Domain: (1..239) [1] 3
```
6. Respond to the remaining prompts, or press **Ctrl-D** to accept the other settings and exit.
7. Enter the **switchEnable** command to re-enable the switch.

## Switch names

Switches can be identified by IP address, domain ID, World Wide Name (WWN), or by customized switch names that are unique and meaningful.

Switch names can be from 1 to 30 characters long. All switch names must begin with a letter, and can contain letters, numbers, or the underscore character. It is not necessary to use quotation marks.

---

#### NOTE

Changing the switch name causes a domain address format RSCN to be issued and may be disruptive to the fabric.

---

### Customizing the switch name

1. Connect to the switch and log in using an account assigned to the admin role.
2. Enter the **switchName** command and enter a new name for the switch.  

```
switch:admin> switchname newname
```
3. Record the new switch name for future reference.

## Chassis names

Brocade recommends that you customize the chassis name for each platform. Some system logs identify devices by platform names; if you assign meaningful platform names, logs are more useful. All chassis names have a limit of 15 characters, except for the Brocade 300, 5100, 5300, and VA-40FC switches, and the 5410, 5424, 5450, and 5480 embedded switches, which allow 31 characters. Chassis names must begin with a letter, and can contain letters, numbers, or the underscore character.

### Customizing chassis names

1. Connect to the switch and log in as admin.
2. Enter the **chassisName** command.

```
ecp:admin> chassisname newname
```

3. Record the new chassis name for future reference.

## Switch activation and deactivation

By default, the switch is enabled after power is applied and diagnostics and switch initialization routines have finished. You can disable and re-enable it as necessary.

### Disabling a switch

1. Connect to the switch and log in using an account assigned to the admin role.
2. Enter the **switchDisable** command.

All Fibre Channel ports on the switch are taken offline. If the switch was part of a fabric, the fabric is reconfigured.

### Enabling a switch

1. Connect to the switch and log in using an account assigned to the admin role.
2. Enter the **switchEnable** command.

All Fibre Channel ports that passed POST are enabled. If the switch has interswitch links (ISLs) to a fabric, it joins the fabric.

## Switch and enterprise-class platform shutdown

To avoid corrupting your file system, Brocade recommends that you perform graceful shutdowns of Brocade switches and enterprise-class platforms.

*Warm reboot* refers to shutting down the appliance per the instructions below, also known as a *graceful shutdown*. *Cold boot* refers to shutting down the appliance by suddenly shutting down power and then turning it back on, also known as a *hard boot*.

### Powering off a Brocade switch

The following procedure describes how to gracefully shut down a switch.

1. Connect to the switch and log in using an account assigned to the admin role.
2. Enter the **sysShutdown** command.
3. At the prompt, enter **y**.

```
switch:admin> sysshutdown
This command will shutdown the operating systems on your switch.
You are required to power-cycle the switch in order to restore operation.
Are you sure you want to shutdown the switch [y/n]?y
```

4. Wait until the following message displays:

```
Broadcast message from root (ttyS0) Wed Jan 25 16:12:09 2006...

The system is going down for system halt NOW !!
INIT: Switching to runlevel: 0
INIT: Sending processes the TERM signal
Unmounting all filesystems.
The system is halted
flushing ide devices: hda
Power down.
```

5. Power off the switch.

### Powering off a Brocade enterprise-class platform

1. From the active CP in a dual-CP platform, enter the **sysShutdown** command.

---

**NOTE**

When the **sysShutdown** command is issued on the active CP, the active CP, the standby CP, and any AP blades are all shut down.

---

2. At the prompt, enter **y**.
3. Wait until you see the following message:

```
DCX:FID128:admin> sysshutdown
This command will shutdown the operating systems on your switch.
You are required to power-cycle the switch in order to restore operation.
Are you sure you want to shutdown the switch [y/n]?y
HA is disabled
Stopping blade 10
Shutting down the blade....
Stopping blade 12
Shutting down the blade....

Broadcast message from root (pts/0) Fri Oct 10 08:36:48 2008...

The system is going down for system halt NOW !!
```

4. Power off the switch.



## Basic connections

Before connecting a switch to a fabric that contains switches running different firmware versions, you must first set the same PID format on all switches. The presence of different PID formats in a fabric causes fabric segmentation.

- For information on PID formats and related procedures, see [Chapter 3, “Performing Advanced Configuration Tasks”](#).
- For information on configuring the routing of connections, see [“Routing Traffic”](#) on page 63.
- For information on configuring extended interswitch connections, see [“Managing Long Distance Fabrics”](#) on page 441.

### Device connection

To minimize port logins, power off all devices before connecting them to the switch. When powering the devices back on, wait for each device to complete the fabric login before powering on the next one.

For devices that cannot be powered off, first use the **portDisable** command to disable the port on the switch, connect the device, and then use the **portEnable** command to enable the port.

### Switch connection

See the hardware user’s guide of your specific switch for interswitch link (ISL) connection and cable management information. The standard or default ISL mode is L0. ISL Mode L0 is a static mode, with the following maximum ISL distances:

- 10 km at 1 Gbps
- 5 km at 2 Gbps
- 2.5 km at 4 Gbps
- 1 km at 8 Gbps

For more information on extended ISL modes, which enable long distance interswitch links, see [Chapter 20, “Managing Long Distance Fabrics”](#).

## 2 Basic connections

# Performing Advanced Configuration Tasks

---

## In this chapter

- [PIDs and PID binding overview](#) . . . . . 35
- [Ports](#) . . . . . 39
- [Blade terminology and compatibility](#) . . . . . 44
- [Enabling and disabling blades](#) . . . . . 48
- [Blade swapping](#) . . . . . 50
- [Power management](#) . . . . . 53
- [Equipment status](#) . . . . . 54
- [Track and control switch changes](#) . . . . . 56
- [Audit log configuration](#) . . . . . 59

## PIDs and PID binding overview

Port identifiers (*PIDs*, also called *Fabric Addresses*) are used by the routing and zoning services in Fibre Channel fabrics to identify ports in the network. All devices in a fabric must use the same PID format. When you add new equipment to the SAN, you might need to change the PID format on legacy equipment.

Many scenarios cause a device to receive a new PID; for example, unplugging the device from one port and plugging it into a different port as part of fabric maintenance, or changing the domain ID of a switch, which might be necessary when merging fabrics, or changing compatibility mode settings.

Some device drivers use the PID to map logical disk drives to physical Fibre Channel counterparts. Most drivers can either change PID mappings dynamically, also called *dynamic PID binding*, or use the WWN of the Fibre Channel disk for mapping, also called *WWN binding*.

Some older device drivers behave as if a PID uniquely identifies a device; they use *static PID binding*. These device drivers should be updated, if possible, to use WWN or dynamic PID binding instead, because static PID binding creates problems in many routine maintenance scenarios. Fortunately, very few device drivers still behave this way. Many current device drivers enable you to select static PID binding as well as WWN binding. You should only select static binding if there is a compelling reason, and only after you have evaluated the effect of doing so.

### Core PID addressing mode

Core PID is the default PID format for Brocade platforms. It uses the entire 24-bit address space of the domain, area\_ID, and AL\_PA to determine an objects address within the fabric.

The Core PID is a 24-bit address built from the following three 8-bit fields:

- domain, written in hex and the numeric range is from 01-ee (1-239)
- area\_ID, written in hex and the numeric range is from 01-ff (1-255)
- AL\_PA

For example, if a device is assigned an address of 0f1e00, the following would apply:

- 0f is the domain ID.
- 1e is the area ID.
- 00 is the assigned AL\_PA.

From this information, you can determine which switch the device resides on from the domain ID, which port the device is attached to from the area\_ID, and if this device is part of a loop from the AL\_PA number.

For more information on reading and converting hexadecimal, refer to [Appendix E, “Hexadecimal”](#).

### Fixed addressing mode

Fixed addressing mode is the default addressing mode used in all platforms that do not have Virtual Fabrics enabled. When Virtual Fabrics is enabled on the Brocade DCX and DCX-4S, fixed addressing mode is used only on the default partition. With fixed addressing mode enabled, each port has a fixed address assigned by the system based on the port number. This address does not change unless you choose to swap the address using the **portSwap** command.

### 10-bit addressing mode

This is the default mode for all the logical switches created in the Brocade DCX and DCX-4S enterprise-class platforms. This addressing scheme is flexible to support a large number of F\_Ports. In the regular 10-bit addressing mode, the **portAddress --auto** command supports addresses from 0x00 to 0x8F.

---

#### NOTE

The default switch in the Brocade DCX and DCX-4S enterprise-class platform still uses the fixed addressing mode in order to support 4 Gbps blades.

---

The 10-bit addressing mode utilizes the 8-bit area\_ID and the borrowed upper two bits from the AL\_PA portion of the PID. Areas 0x00 through 0x8F use only 8 bits for the port address and support up to 256 NPIV devices. This means a logical switch can support up to 144 ports that can each support 256 devices. Areas 0x90 through 0xFF use an additional two bits from ALPA for the port address. Hence these ports support only 64 NPIV devices per port.

10-bit addressing mode allows for the following functionalities:

- PID is dynamically allocated only when the port is first moved to a logical switch and thereafter it is persistently maintained.
- Shared area limitations are removed on 48-port blades.

- Any port on a 48-port blade can support up to 256 NPIV devices (in fixed addressing mode, only 128 NPIV devices are supported in non-VF mode and 64 NPIV devices in VF mode on a 48-port blade).
- Any port on a 48-port blade can support loop devices.
- Any port on a 48-port blade can support hard port zoning.
- Port index is not guaranteed to be equal to the port area\_ID.

## 256-area addressing mode

This configurable addressing mode is available only in a logical switch on the Brocade DCX and DCX-4S platforms. In this mode, only 256 ports are supported and each port receives a unique 8-bit area address. This mode can be used in FICON environments, which have strict requirements for 8-bit area FC addresses.

There are two types of area assignment modes in the 256-area addressing mode: zero-based and port-based. Zero-based mode, which assigns areas as ports, are added to the partition, beginning at area 0x00. This mode allows FICON customers to make use of the upper ports of a 48-port blade; but this mode may not be compatible with *domain,index* zoning in InteropMode 2, because M-EOS switches are not capable of handling indexes greater than 255. In both zero-based and port-based modes, you can assign from the entire range 0x00 to 0xff for the PID. Port-based mode does not support the upper 16 ports of a 48 port blade in a logical switch.

## WWN-based PID assignment

WWN-based PID assignment is disabled by default. When the feature is enabled, bindings are created dynamically; as new devices log in, they automatically enter the WWN-based PID database. The bindings exist until you explicitly unbind the mappings through the CLI or change to a different addressing mode. If there are any existing devices when you enable the feature, you must manually enter the WWN-based PID assignments through the CLI.

This feature also allows you to configure a PID persistently using a device WWN. When the device logs in to the switch, the PID is bound to the device WWN. If the device is moved to another port in the same switch, or a new blade is hot plugged, the device receives the same PID (area) at its next login.

Once WWN-based PID assignment is enabled you must manually enter the WWN-based PID assignments through the CLI for any existing devices.

---

### ATTENTION

When WWN-base PID assignment is enabled, the area assignment is dynamic and does not guarantee any order in the presence of static wwn-area binding or when the devices are moved around.

---

PID assignments are supported for a maximum of 4096 devices; this includes both point-to-point and NPIV devices. The number of point-to-point devices supported depends directly on the areas available. For example, 448 areas are available on an enterprise-class platform and 256 areas are available on switches. When the number of entries in the WWN-based PID database reaches 4096 areas are used up, the oldest unused entry is purged from the database to free up the reserved area for the new FLOGI.

### *Virtual Fabric considerations*

WWN-base PID assignment is disabled by default and is supported in the default switch on a Brocade DCX and DCX-4S. This feature is not supported on application blades such as the FS8-18, FX8-24, and the FCOE10-24. The total number of ports in the default switch must be 256 or less.

When the WWN-base PID assignment feature is enabled and a new blade is plugged into the chassis, the ports for which the area is not available are disabled.

### *NPIV*

If any NPIV devices have static PIDs configured and the acquired area is not the same as the one being requested, the FDISC coming from that device is rejected and the error is noted in the RASlog.

If the NPIV device has Dynamic Persistent PID set, the same AL\_PA value in the PID is used. This guarantees NPIV devices get the same PID across reboots and AL\_PAs assigned for the device do not depend on the order in which the devices come up. Refer to [Chapter 13, “Administering NPIV”](#) for more information on NPIV.

### *Enabling automatic PID assignment*

---

#### **NOTE**

To activate the WWN-based PID assignment, you do not need to disable the switch.

---

1. Connect to the switch and log in using an account assigned to the admin role.
2. Enter the **configure** command.
3. At the **Fabric Parameters** prompt, type **y**
4. At the **WWN Based persistent PID** prompt, type **y**
5. Press **Enter** to bypass the remaining prompts without changing them.

#### **Example of activating PID assignments**

```
Configure...

Fabric parameters (yes, y, no, n): [no] y

  WWN Based persistent PID (yes, y, no, n): [no] y
  System services (yes, y, no, n): [no]
  ssl attributes (yes, y, no, n): [no]
  rpcd attributes (yes, y, no, n): [no]
  cfgload attributes (yes, y, no, n): [no]
  webtools attributes (yes, y, no, n): [no]
  Custom attributes (yes, y, no, n): [no]
  system attributes (yes, y, no, n): [no]
```

### *Assigning a static PID*

1. Connect to the switch and log in using an account assigned to the admin role.
2. Enter the **wwnAddress -bind** command to assign a 16-bit PID to a given WWN.

### *Clearing PID binding*

1. Connect to the switch and log in using an account assigned to the admin role.
2. Enter the **wwnAddress -unbind** command to clear the PID binding for the specified WWN.

### *Showing PID assignments*

1. Connect to the switch and log in using an account assigned to the admin role.
2. Based on what you want to display, enter the appropriate command:
  - **wwnAddress -show** displays the assigned WWN-PID bindings.
  - **wwnAddress -findPID wwn** displays the PID assigned to the device WWN specified.

## Ports

Because enterprise-class platforms contain interchangeable port blades, their procedures differ from those for fixed-port switches. For example, fixed-port models identify ports only by the port number, while enterprise-class platforms identify ports by *slot/port* notation.

---

#### NOTE

For detailed information about the Brocade 48000 director, and the Brocade DCX and DCX-4S enterprise-class platforms, see the *Brocade 48000 Hardware Reference Manual*, the *Brocade DCX Data Center Backbone Hardware Reference Manual*, and the *Brocade DCX-4S Data Center Backbone Hardware Reference Manual*, respectively.

---

The different blades that can be inserted into a chassis are described as follows:

- Control processor blades (CPs) contain communication ports for system management, and are used for low-level, platform-wide tasks. In the Brocade 48000, CPs are used for intra-platform switching.
- Core blades in the Brocade DCX (CORE8) and DCX-4S (CR4S-8) are used for intra-chassis switching as well as interconnecting two Brocade DCX enterprise-class platforms.
- Port blades are used for host, storage, and interswitch connections.
- AP blades are used for Fibre Channel Application Services and Routing Services, iSCSI bridging, FCIP, Converged Enhanced Ethernet, storage virtualization, and encryption support.

---

#### NOTE

On each port blade, a particular port must be represented by both slot number and port number.

---

The Brocade 48000 has 10 slots that contain control processor, port, and application (AP) blades:

- Slot numbers 5 and 6 contain control processor blades.
- Slot numbers 1 through 4 and 7 through 10 contain port and AP blades.

The Brocade DCX has 12 slots that contain control processor, core, port, and AP blades:

- Slot numbers 6 and 7 contain CPs.
- Slot numbers 5 and 8 contain core blades.
- Slot numbers 1 through 4 and 9 through 12 contain port and AP blades.

The Brocade DCX-4S has 8 slots that contain control processor, core, port, and AP blades:

- Slot numbers 4 and 5 contain CPs.
- Slot numbers 3 and 6 contain core blades.
- Slot numbers 1 and 2, and 7 and 8 contain port and AP blades.

---

## NOTE

The Core blades for the Brocade DCX (CORE8) and the Brocade DCX-4S (CR4S-8) are not interchangeable between the two products.

---

When you have port blades with different port counts in the same director (for example, 16-port blades and 32-port blades, or 16-port blades and 18-port blades with 16 FC ports and 2 GbE ports, or 16-port and 48-port blades), the area IDs no longer match the port numbers. [Table 3](#) lists the port numbering schemes for the Brocade 48000, and the Brocade DCX and DCX-4S enterprise-class platforms.

**TABLE 3 Port numbering schemes for the Brocade 48000, Brocade DCX and DCX-4S enterprise-class platforms**

Port blades	Numbering scheme
FC2-16 FC4-16 FC8-16	Ports are numbered from 0 through 15 from bottom to top.
FC4-32 FC8-32	Ports are numbered from 0 through 15 from bottom to top on the left set of ports and 16 through 31 from bottom to top on the right set of ports.
FC4-48 FC8-48	Ports are numbered from 0 through 23 from bottom to top on the left set of ports and 24 through 47 from bottom to top on the right set of ports.
FC8-64	Ports are numbered from 0 through 32 from bottom to top on the left set of ports and 33 through 64 from bottom to top on the right set of ports.
FC10-6	Ports are numbered from 0 through 5 from bottom to top.
FC4-16IP	Fibre Channel ports are numbered from 0 through 7 from bottom to top. There are also 8 GbE ports (numbered ge0 – ge7, from bottom to top). Going from bottom to top, the 8 FC ports appear on the bottom, followed by the 8 GbE ports at the top.
FA4-18	Fibre Channel ports are numbered from 0 through 15 from bottom to top. There are also 2 GbE ports (numbered A0 - A1, from top to bottom) that are for Storage Application manageability purposes; you cannot address these ports using the CLI.
FR4-18i	Ports are numbered from 0 through 15 from bottom to top. There are also 2 GbE ports (numbered ge0-ge1, from bottom to top). Going from bottom to top, the 2 GbE ports appear on the bottom of the blade followed by 16 FC ports.
FS8-18	Ports are numbered from 0 through 15 from bottom to top. There are also 2 GbE ports (numbered ge0-ge1, from top to bottom). Going from top to bottom, the 2 GbE ports appear on the top of the blade followed by 16 FC ports.
FCOE10-24	Ports are numbered 0 through 11 from bottom to top on the left set of ports and 12 through 24 from bottom to top on the right set of ports.
FX8-24	In the first grouping, there are Fibre Channel ports numbered 0 through 5 from bottom to top on the left set of ports and 6 through 11 from bottom to top on the right set of ports. In the second grouping, there are two 10 GbE ports numbered xge0 and xge1 on the left set of ports and two GbE ports numbered ge4 and ge5 on the right side. In the third grouping, the GbE ports are numbered ge0 through ge3 on the left set of ports and ge6 through ge9 on the right set of ports.

---



## Setting port names

Perform the following steps to specify a port name. For enterprise-class directors, specify the slot number where the blade is installed.

1. Connect to the switch and log in using an account assigned to the admin role.
2. Enter the **portName** command.

### Example of naming port 0

```
ecp:admin> portname 1/0 trunk1
```

## Port identification by slot and port number

The port number is a number assigned to an external port to give it a unique identifier in a switch.

To select a specific port in the Brocade 48000, Brocade DCX and DCX-4S enterprise-class platforms, you must identify both the slot number and the port number using the format *slot number/port number*. No spaces are allowed between the slot number, the slash (/), and the port number.

### Example of enabling port 4 on a blade in slot 2

```
ecp:admin> portenable 2/4
```

## Port identification by port area ID

The relationship between the port number and area ID depends upon the PID format used in the fabric. When Core PID format is in effect, the area ID for port 0 is 0, for port 1 is 1, and so forth.

For 32-port blades (FC4-32, FC8-32), the numbering is contiguous up to port 15; from port 16, the numbering is still contiguous, but starts with 128. For example, port 15 in slot 1 has a port number and area ID of 15; port 16 has a port number and area ID of 128; port 17 has a port number and area ID of 129.

For 48-port blades (FC4-48, FC8-48), the numbering is the same as for 32-port blades for the first 32 ports on the blade. For ports 32 through 47, area IDs are not unique and port index should be used instead of area ID.

For the 64-port blade (FC8-64), the numbering is the same as for 32-port blades for the first 32 ports on the blade. For ports 32 through 64, area IDs are not unique and port index should be used instead of area ID.

If you perform a port swap operation, the port number and area ID no longer match. On 48-port blades, port swapping is supported only on ports 0–15.

To determine the area ID of a particular port, enter the **switchShow** command. This command displays all ports on the current (logical) switch and their corresponding area IDs.

## Port identification by index

With the introduction of 48-port blades, indexing was introduced. Unique area IDs are possible for up to 255 areas, but beyond that there needed to be some way to ensure uniqueness.

A number of fabric-wide databases supported by Fabric OS (including ZoneDB, the ACL DDC, and Admin Domain) allow a port to be designated by the use of a “D,P” (*domain,port*) notation. While the “P” component appears to be the port number, for up to 255 ports it is actually the *area* assigned to that port.

---

**ATTENTION**

Port area schema does not apply to the Brocade DCX-4S enterprise-class platform.

---

If two ports are changed using the **portSwap** command, their respective areas and “P” values are exchanged.

For ports that are numbered above 255, the “P” value is actually a logical index. The first 256 ports continue to have an index value equal to the area\_ID assigned to the port. If a switch is using Core PID format, and no port swapping has been done, the port index value for all ports is the same as the physical port numbers. Using **portSwap** on a pair of ports will exchange those ports’ area\_ID and index values.

---

**NOTE**

The **portSwap** command is not supported for ports above 256.

---

## Swapping port area IDs

If a device that uses port binding is connected to a port that fails, you can use port swapping to make another physical port use the same PID as the failed port. The device can then be plugged into the new port without the need to reboot the device.

Use the following procedure to swap the port area IDs of two physical switch ports. In order to swap port area IDs, the port swap feature must be enabled, and both switch ports must be disabled. The swapped area IDs for the two ports remain persistent across reboots, power cycles, and failovers.

**Brocade 48000 and Brocade DCX platforms only:** You can swap only ports 0 through 15 on the FC4-48 and FC8-48 port blades. You cannot swap ports 16 through 47.

1. Connect to the switch and log in using an account assigned to the admin role.
2. Enable the **portSwapEnable** command to enable the feature.
3. Enter the **portDisable** command on each of the source and destination ports to be swapped.

```
switch:admin>portdisable 1  
ecp:admin>portdisable 1/2
```

4. Enter the **portSwap** command.

```
switch:admin>portswap 1 2  
ecp:admin>portswap 1/1 2/2
```

5. Enter the **portSwapShow** command to verify that the port area IDs have been swapped.

A table shows the physical port numbers and the logical area IDs for any swapped ports.

6. Enter the **portSwapDisable** command to disable the port swap feature.

## Port activation and deactivation

By default, all licensed ports are enabled. You can disable and re-enable them as necessary. Ports that you activate with the Ports on Demand license must be enabled explicitly, as described in [“Ports on Demand”](#) on page 377.

If ports are persistently disabled and you use the **portEnable** command to enable a disabled port, the port will revert to being disabled after a power cycle or a switch reboot. To ensure the port remains enabled, use the **portCfgPersistentEnable** command as instructed below.



#### **CAUTION**

The fabric will be reconfigured if the port you are enabling or disabling is connected to another switch.

The switch with a port that has been disabled will be segmented from the fabric and all traffic flowing between it and the fabric will be lost.

### *Enabling a port*

1. Connect to the switch and log in using an account assigned to the admin role.
2. Enter the appropriate command based on the current state of the port and on whether it is necessary to specify a slot number:
  - To enable a port that is disabled, enter the command **portEnable** *portnumber* or **portEnable** *slotnumber/portnumber*.
  - To enable a port that is persistently disabled, enter the command **portCfgPersistentEnable** *portnumber* or **portCfgPersistentEnable** *slotnumber/portnumber*.

If you change port configurations during a switch failover, the ports may become disabled. To bring the ports online, re-issue the **portEnable** command after the failover is complete.

### *Disabling a port*

1. Connect to the switch and log in using an account assigned to the admin role.
2. Enter the appropriate command based on the current state of the port and on whether it is necessary to specify a slot number:
  - To enable a port that is disabled, enter the command **portDisable** *portnumber* or **portDisable** *slotnumber/portnumber*.
  - To enable a port that is persistently disabled, enter the command **portCfgPersistentDisable** *portnumber* or **portCfgPersistentDisable** *slotnumber/portnumber*.

## Setting port speeds

1. Connect to the switch and log in using an account assigned to the admin role.
2. Enter the **portCfgSpeed** command.

#### **Example of setting the port speed**

The following example sets the speed for port 3 on slot 2 to 4 Gbps:

```
eyp:admin> portcfgspeed 2/3 4
done.
```

The following example sets the speed for port 3 on slot 2 to autonegotiate:

```
eyp:admin> portcfgspeed 2/3 0
done.
```

## Setting the same speed for all ports on the switch

1. Connect to the switch and log in using an account assigned to the admin role.
2. Enter the `switchCfgSpeed` command.

### Example of setting the switch speed

The following example sets the speed for all ports on the switch to 8 Gbps:

```
switch:admin> switchcfgspeed 8
Committing configuration...done.
```

The following example sets the speed for all ports on the switch to autonegotiate:

```
switch:admin> switchcfgspeed 0
Committing configuration...done.
```

## Blade terminology and compatibility

Before configuring a chassis, familiarize yourself with the platform CP blade and port blade nomenclature, as well as the port blade compatibilities. Often in procedures, only the abbreviated names for CP and port blades are used (for example, the FC4-16 blade). [Table 4](#) includes CP and port blade abbreviations and descriptions.

**TABLE 4 Brocade enterprise-class platform terminology and abbreviations**

Term	Abbreviation	Blade ID (slotshow)	Definition
Brocade 48000 control processor blade	CP256	16	The third generation CP blade provided with the Brocade 48000. This CP supports 1, 2, 4, 8, and 10 Gbps port speeds, as well as 16-, 32-, and 48-port blades.
Brocade DCX and DCX-4S control processor blade	CP8	50	The CP blade provided with the Brocade DCX. This CP supports 1, 2, 4, 8, and 10 Gbps port speeds, as well as 16-, 32-, 48-, and 64-port blades. <b>Note:</b> These blades are interchangeable between the Brocade DCX and DCX-4S.
Brocade DCX core blade	CORE8	52	A 16-port blade that provides 8 Gbps connectivity between port blades in the Brocade DCX chassis. <b>Note:</b> These blades are not interchangeable with the Brocade DCX-4S.
Brocade DCX-4S core blade	CR4S-8	46	A 16-port blade that provides 8 Gbps connectivity between port blades in the Brocade DCX-4S chassis. <b>Note:</b> These blades are not interchangeable with the Brocade DCX.
16-port 2-Gbps port blade	FC2-16	4	The second generation Brocade 16-port blade supporting 1 and 2 Gbps port speeds. This port blade is compatible only with the Brocade 48000 CP blades.
16-port 4-Gbps port blade	FC4-16	17	The third generation Brocade platform 16-port blade supporting 1, 2, and 4 Gbps port speeds. This port blade is compatible only with the Brocade 48000 CP blades.
16-port 8-Gbps port blade	FC8-16	21	A 16-port Brocade platform port blade supporting 1, 2, 4, and 8 Gbps port speeds.

**TABLE 4 Brocade enterprise-class platform terminology and abbreviations (Continued)**

Term	Abbreviation	Blade ID (slotshow)	Definition
32-port 4-Gbps port blade	FC4-32	18	A 32-port Brocade platform port blade supporting 1, 2, and 4 Gbps port speeds. This port blade is compatible only with the Brocade 48000 CP blades.
32-port 8-Gbps port blade	FC8-32	55	A 32-port Brocade platform port blade supporting 1, 2, 4, and 8 Gbps port speeds.
48-port 4-Gbps port blade	FC4-48	36	A 48-port Brocade platform port blade supporting 1, 2, and 4 Gbps port speeds in chassis mode 5 with port and exchange-based routing. This port blade is compatible only with the Brocade 48000 CP blades. FC4-48 blades do not support FL_Ports.
48-port 8-Gbps port blade	FC8-48	51	A 48-port Brocade platform port blade supporting 1, 2, 4, and 8 Gbps port speeds. The Brocade DCX and DCX-4S support loop devices on 48-port blades in a Virtual Fabric-enabled environment.
64-port 8-Gbps port blade	FC8-64	77	A 64-port Brocade platform port blade supporting 2, 4, and 8 Gbps port speeds. The Brocade DCX and DCX-4S support loop devices on 64-port blades in a Virtual Fabric-enabled environment. The loop devices can only be attached to ports on a 64-port blade that is not a part of the default logical switch.
6-port 10-Gbps port blade	FC10-6	39	A 6-port Brocade platform port blade supporting 10 Gbps port speed. Blade provides 10-Gbps ISLs. This port blade is compatible only with the Brocade 48000 CP blades (using chassis configuration option 5) and the Brocade DCX and DCX-4S CP blades.
Fibre Channel Router blade	FR4-18i	24	A 16-port Fibre Channel routing and FCIP blade that also has 2 GbE ports and is compatible only with the Brocade 48000 (using chassis configuration option 5) and the Brocade DCX and DCX-4S CP blades.
iSCSI Bridge blade	FC4-16IP	31	An iSCSI bridge blade that enables bridging of iSCSI hosts to Fibre Channel fabrics. It has 8 Fibre Channel optical SFP ports and 8 GbE copper RJ-45 ports. This blade is currently compatible with the Brocade 48000 CP blades (using chassis configuration option 5).
Fibre Channel Application blade	FA4-18	33	An application blade that has 16 (1-, 2-, and 4-Gbps) ports supporting Fibre Channel Application Services and two 10/100/1000 BaseT Ethernet copper interfaces supporting blade management.
Brocade Encryption blade	FS8-18	68	An application blade that provides high performance 32-port auto-sensing 8 Gbps Fibre Channel connectivity with data cryptographic (encryption/decryption) and data compression capabilities.
Converged Enhanced Ethernet blade	FCOE10-24	74	An application blade that provides Converged Enhanced Ethernet to bridge a Fibre Channel and Ethernet SAN.
DCX Extension blade	FX8-24	75	A 24-port Fibre Channel routing and FCIP blade that also has 10 1-GbE and two 10-GbE ports and is compatible only with the Brocade DCX and DCX-4S CP blades.

## CP blades

The control processor (CP) blade provides redundancy and acts as the brains of the enterprise-class platform. The Brocade 48000 supports the CP256 blade. The Brocade DCX and DCX-4S support the CP8 blades.

The CP blades in the Brocade DCX and DCX-4S are hot-swappable. When the CPs from a Brocade DCX are inserted into a Brocade DCX-4S, the switch type changes. The same is true when inserting a CP blade from a Brocade DCX-4S into a Brocade DCX. When a CP blade with a Fabric OS prior to v6.2.0 is inserted into a Brocade DCX-4S, the blade becomes faulty. You can correct this issue by upgrading the firmware on the CP blade in a Brocade DCX or DCX-4S chassis.

Mixed CP blades are not supported on a single chassis, except during specific upgrade procedures detailed in the *Brocade 48000 Hardware Reference Manual*. CP4 and CP8 blades cannot be mixed in the same chassis under any circumstances. Brocade recommends that each Brocade platform have only one type of CP blade installed and that each CP (primary and secondary partition) maintains the same firmware version.

For more information on maintaining firmware in your enterprise-class platform, refer to [Chapter 9, “Installing and Maintaining Firmware”](#).

## Core blades

Core blades provide intra-chassis switching and ICL connectivity between DCX platforms. The Brocade DCX supports two CORE8 core blades. The Brocade DCX-4S supports two CR4S-8 core blades. This blade is not interchangeable or hot-swappable with the Brocade DCX core blades. If you try to interchange the blades they become faulty.

The Brocade 48000 does not support core blades.

## Port and application blade compatibility

[Table 5](#) identifies which port and application blades are supported for each Brocade platform.

**TABLE 5** Port blades supported by each platform

Port blades	Brocade 48000 (CP4)	Brocade DCX and DCX-4S
FA4-18	Supported	Supported
FC10-6	Supported	Supported
FC4-16	Supported	Unsupported
FC4-16IP	Supported	Unsupported
FC4-32	Supported	Unsupported
FC4-48	Supported	Unsupported
FC8-16	Supported	Supported
FC8-32	Supported	Supported
FC8-48	Supported	Supported
FC8-64	Unsupported	Supported
FCOE10-24 <sup>1</sup>	Unsupported	Supported
FR4-18i	Supported	Supported

**TABLE 5** Port blades supported by each platform (Continued)

Port blades	Brocade 48000 (CP4)	Brocade DCX and DCX-4S
FS8-18	Unsupported	Supported
FX8-24	Unsupported	Supported

1. During power up when an FCOE10-24 is detected first before any other AP blade in a chassis with Fabric OS v6.3.0 and later, all other AP and FC8-64 blades will be faulted. If a non-FCOE10-24 blade is detected first, then any subsequently-detected FCOE10-24 blades will be faulted. Blades are powered up starting with slot 1.

The maximum number of application blades supported on a Brocade DCX is eight with any combination. For example, 4 FA4-18, 8 FR4-18i. There is no restriction on port blades (FC8-16, FC8-32, FC8-48, FC10-6 and FC8-64). The FC8-64 is supported, but only with Fabric OS v6.4.0.

The maximum number of application blades supported on a Brocade DCX-4S is four with any combination. There is no restriction on port blades (FC8-16, FC8-32, FC8-48, FC10-6, and FC8-64). The FC8-64 is supported, but only with Fabric OS v6.4.0.

[Table 6](#) lists the maximum number of application blades you can insert in a Brocade DCX and DCX-4S backbone chassis for a specific Fabric OS release. Software functionality is not supported across application blades.

**TABLE 6** Blade compatibility within a Brocade DCX and DCX-4S backbone

Intelligent blade	Fabric OS v6.2.0		Fabric OS v6.3.0		Fabric OS v6.4.0	
	DCX	DCX-4S	DCX	DCX-4S	DCX	DCX-4S
FR4-18i <sup>1</sup>	8	4	8	4	8	4
FA4-18 <sup>2</sup>	2	4	2	4	4	4
FS8-18	4	4	4	4	4	4
FCOE10-24 <sup>3</sup>	n/a	n/a	2	2	2	2
FX8-24 <sup>4</sup>	n/a	n/a	2	4	4	4

1. On the Brocade 48000, the blade can co-exist with an FC4-16IP, but the iSCSI devices are not exported and imported for FC routing services. The iSCSI functionality over FCIP is not supported, but the FCIP link is the same as other FC E\_Ports. This is not restricted by software.

2. The hardware limit is enforced by software. The FA4-18 blade can co-exist with the FR4-18i (and interoperable at the Layer 2 level), but there is no multi-protocol-level interoperability support provided. Coexistence implies that both types of blades are able to reside in the same chassis. Additionally, FA4-18 blade Layer 2 functions should be compatible with FCR, FCIP, and iSCSI (iSCSI on the Brocade 48000 only). Specifically for FCR coexistence, physical devices directly connected to the FA4-18 blade can be exported to edge fabrics and physical devices directly connected to the FA4-18 blade can communicate with devices imported into the backbone fabric. Similar coexistence of physical devices connected to the FA4-18 blade applies to FCIP and iSCSI.

3. Not compatible with other application blades or with the FC8-64 in the same chassis. Refer to [Table 5](#) on page 46 for more information.

4. The hardware limit is enforced by software.

### FX8-24 compatibility notes

When you have an FR4-18i and an FX8-24 blade in your chassis, the following guidelines need to be followed:

- The FR4-18i and Brocade 7500 GbE ports cannot be connected to either the FX8-24 or Brocade 7800 GbE ports. The ports may come online, but they will not communicate with each other. Running physical cables between the FR4 -18i and FX8-24 blades is not supported.
- The port configuration is maintained separately for the GbE ports of the FR4 -18i and FX8-24 blades. The port configuration data of one blade is never applied to the other type even if an FX8-24 replaces an FR4-18i in the same slot of a chassis. However, if an FR4 -18i blade is replaced with an FX8-24 blade and then replaced back with an FR4 -18i, the FR4 -18i previous IP configuration data would be applied to the new FR4 -18i. The same behavior applies if you were to replace the FX8-24 with an FX8-24.
- When Virtual Fabrics is disabled, replacing an FR4 -18i with an FX8-24 (and vice-versa) is allowed without any pre-conditions
- When Virtual Fabrics is enabled (regardless of whether the FR4 -18i or FX8-24 blade is in the default switch), replacing an FR4 -18i with an FX8-24 (and vice-versa) without rebooting or power cycling the chassis will fault the blade with reason code 91. However, after blade removal, if you reboot or power cycle the chassis, inserting the other blade type is allowed.
- The data paths in both blades are interoperable between FC ports. FR4-18i FC ports can stream data over FX8-24 GbE ports and vice versa.
- The FX8-24 blade cannot co-exist with the FA4-18, FS8-18, and FCOE10-24 blades. For example, you cannot have an FA4-18 virtual device exported to an edge fabric, getting encrypted over an FS8-18 blade, and then going over an FX8-24 FCIP distance VE\_Port. There is no software enforcement to detect the above configuration.

## Enabling and disabling blades

Port blades are enabled by default. In some cases, you will need to disable a port blade to perform diagnostics. When diagnostics are executed manually (from the Fabric OS command line), many commands require the port blade to be disabled. This ensures that diagnostic activity does not interfere with normal fabric traffic.

If you need to replace an application blade with a different application blade, there are extra steps you need to take to ensure that the previous configuration is not interfering with your new application blade.

### Enabling blades

1. Connect to the switch and log in as admin.
2. Enter the **bladeEnable** command with the slot number of the port blade you want to enable.

```
ecp:admin> bladeenable 3  
Slot 3 is being enabled
```



### ***FA4-18 application blade enabling exceptions***

The Brocade 48000 director supports up to two FA4-18 blades in a chassis. The Brocade DCX and DCX-4S Backbones support up to four FA4-18 blades in a chassis.

### ***FC4-48 and FC8-48 port blade enabling exceptions***

Because the area IDs are shared with different port IDs, the FC4-48 and FC8-48 blades support only F\_ and E\_Ports. They do not support FL\_Ports.

Port swapping on an FC4-48 or FC8-48 is supported only on ports 0–15. For the FC8-32 port blade, port swapping is supported on all 32 ports. This means that if you replace a 32-port blade where a port has been swapped on ports 16–31 with a 48-port blade, the 48-port blade faults. To correct this, reinsert the 32-port blade and issue **portSwap** to restore the original area IDs to ports 16–31.

### ***FR4-18i application blade enabling exceptions***

Note the following exceptions to enabling the FR4-18i application blade:

- You have inserted the FR4-18i blade into a slot that was previously empty or contained an FA4-18, FC4-16IP, FC4-48, FC8-16, FC8-32, FC8-48, FC10-6, FS8-18.

If the FR4-18i blade is operational and the platform is rebooted, then after the successful bootup of the system the blade continues operations using the previous configurations.

If a previously configured FR4-18i blade is removed and another or the same FR4-18i blade is inserted into the same slot, then the ports use the previous configuration and come up enabled. If you do not want to use the previous configuration, you must clear the configuration information, remove the blade, and then reseat the blade.

If a previously-configured FR4-18i blade is removed and an FC4-48, FC8-16, FC8-32, FC8-48, or FC10-6 blade is plugged in, then—other than the port's EX\_Port configuration—all the remaining port configurations previously applied to the FR4-18i ports can be used. The EX\_Port configuration on those ports is disabled before the FC4 or FC8 port blade becomes operational. When a blade is present in the slot, then any requested port configuration is validated against the blade's capabilities before accepting the request. Also, hot swapping causes the ports on the FR4-18i to be persistently disabled which later need to be enabled.

---

#### **NOTE**

The FC4-16IP blade is not supported in either the Brocade DCX or DCX-4S enterprise-class platform.

---

- You have turned on the power to the chassis and the FR4-18i blade in that slot was not active prior to the power-on you must persistently enable the ports manually. For instructions on how to manually persistently enable a port, refer to "[Port activation and deactivation](#)" on page 42.

---

#### **ATTENTION**

The ports of an FR4-18i are persistently disabled only if an FR4-18i was not previously in that slot. You can replace an FR4-18i with another one with no change in the port states.

---

To summarize:

- When an FC4-16, FC4-32, FC8-16, FC8-32, FC10-6, FC4-16IP, FA4-18, FS8-18, or FX8-24 blade is replaced by an FR4-18i blade, the current port configuration continues to be used, and all ports on the FR4-18i blade are persistently disabled.

## 3 Blade swapping

- When an FR4-18i blade is replaced by an FC4-16, FC4-32, FC8-16, FC8-32, FC8-48, or FC8-64 blade, then the EX\_Port configuration is removed from any ports that were configured as EX\_Ports (equivalent to disabling the EX\_Port configuration using the **portCfgEXPort** command). All remaining port configurations are retained.

---

### NOTE

This is not true for the 8-Gbps port blades. Because FC8- type blades support EX\_Ports, they are still retained in the configuration, but the ports are persistently disabled.

The FC10-6 blade does not support EX\_Ports.

---

## Disabling blades

1. Connect to the switch and log in as admin.
2. Enter the **bladeDisable** command with the slot number of the port blade you want to disable.

```
ecp:admin> bladedisable 3  
Slot 3 is being disabled
```

## Blade swapping

Blade swapping allows you to swap one blade with another of the same type; in this way, you can perform a FRU replacement with minimal traffic disruption. The entire operation is accomplished when the **bladeSwap** command runs on the Fabric OS. The Fabric OS then validates each command before actually implementing the command on the enterprise-class platform. If an error is encountered then blade swap quits without disrupting traffic flowing through the blades. If an unforeseen error does occur during the **bladeSwap** command, an entry will be made into the RASlog and all ports that have been swapped as part of the blade swap operation will be swapped back. On successful completion of the command, the source and destination blades are left in a disabled state allowing you to complete the cable move.

Blade swapping is based on port swapping and has the same restrictions:

- Shared area ports cannot be swapped.
- Ports that are part of a trunk group cannot be swapped.
- GbE ports cannot be swapped.
- Swapping ports between different logical switches is not supported. The ports on the source and destination blades need to be in the same logical switch.
- Undetermined board types cannot be swapped. For example, a blade swap will fail if the blade type cannot be identified.
- Blade swapping is not supported when swapping to a different model of blade or a different port count. For example, you cannot swap an FC8-32 blade with an FC8-48 port blade.

---

### NOTE

This feature is not supported on the FX8-24 DCX Extension blade.

---

## Swapping blades

The `bladeSwap` command performs the following operations:

### 1. Blade selection

The selection process includes selecting the switch and the blades to be affected by the swap operation. [Figure 2](#) shows the source and destination blades are identified to begin the process.

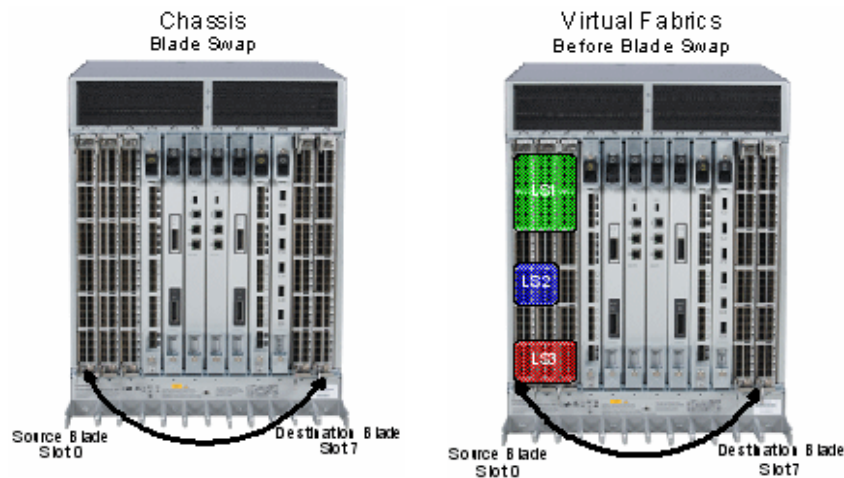

**FIGURE 2** Identifying the blades

### 2. Blade validation

The validation process includes determining the compatibility between the blades selected for the swap operation:

- **Blade technology.** Both blades must be of compatible technology types (for example, Fibre Channel to Fibre Channel, Ethernet to Ethernet, application to application, etc).
- **Port Count.** Both blades must support the same number of front ports. For example, 16-ports to 16-ports, 32-ports to 32-ports, 48-ports to 48-ports, and so on.
- **Availability.** The ports on the destination blade must be available for the swap operation and not attached to any other devices.

### 3. Port preparation

The process of preparing ports for a swap operation includes basic operations such as insuring the source and destination ports are offline, or verifying that none of the destination ports have failed.

The preparation process also includes any special handling of ports associated with logical switches. For example [Figure 3](#) shows the source blade has ports in a logical switch or logical fabric, then the corresponding destination ports must be included in the associated logical switch or logical fabric of the source ports.

### 3 Blade swapping

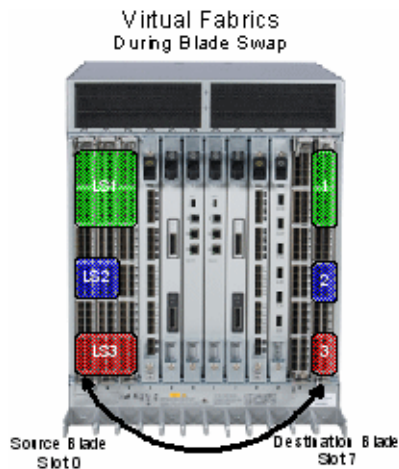

FIGURE 3 Blade swap with Virtual Fabrics during the swap

#### 4. Port swapping

The swap ports action is effectively an iteration of the **portSwap** command for each port on the source blade to each corresponding port on the destination blade.

In [Figure 4](#) shows Virtual Fabrics, where the blades can be carved up into different logical switches as long as they are carved the same way. If slot 1 and slot 2 ports 0-7 are all in the same logical switch, then blade swapping slot 1 to slot 2 will work. The entire blade does not need to be in the same partition.

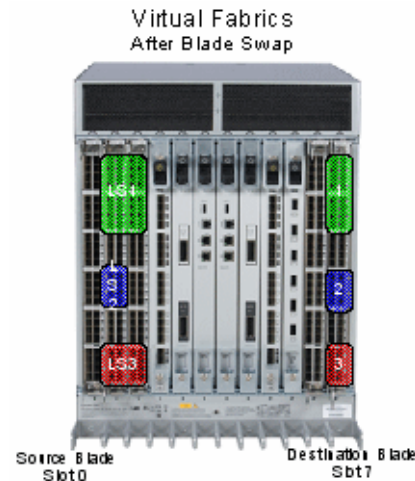

FIGURE 4 Blade swap with Virtual Fabrics after the swap

## Swapping blades

1. Connect to the director and log in using an account assigned to the admin role.
2. Enter the **bladeSwap** command.

If no errors are encountered, the blade swap will complete successfully. If errors are encountered, the command is interrupted and the ports are set back to their original configuration.

3. Once the command completes successfully, move the cables from the source blade to the destination blade.
4. Enter the **bladeEnable** command on the destination blade to enable all user ports.

## Power management

All blades are powered on by default when the switch chassis is powered on. Blades cannot be powered off when POST or AP initialization is in progress.

To manage power and ensure that more critical components are the least affected by a power changes, you can specify the order in which the components are powered off, using the **powerOffListSet** command

The power monitor compares the available power with the power required to determine if there will be enough power to operate. If it is predicted to be less power available than required, the power-off list is processed until there is enough power for operation. By default, the processing begins with slot 1 and proceeds to the last slot in the chassis. As power becomes available, slots are powered up in the reverse order. During the initial power up of a chassis, or using the **slotPowerOn** command, or the insertion of a blade, the available power is compared to required power before power is applied to the blade.

---

### NOTE

Some FRUs in the chassis may use significant power, yet cannot be powered off through software. For example, a missing blower FRU may change the power computation enough to affect how many slots can be powered up.

---

The **powerOffListShow** command displays the power off order.

---

### NOTE

In the Brocade DCX and DCX-4S the core blades and CPs cannot be powered off from the CLI interface. You must manually power off the blades by lowering the slider or removing power from the chassis. If there is no CP up and running then physical removal or powering off the chassis is required.

---

## Powering off a port blade

1. Connect to the switch and log in as admin.
2. Enter the **slotPowerOff** command with the slot number of the port blade you want to power off.

```
ecp:admin> slotpoweroff 3  
Slot 3 is being powered off
```

## Powering on a port blade

1. Connect to the switch and log in as admin.
2. Enter the **slotPowerOn** command with the slot number of the port blade you want to power on.

```
ecp:admin> slotpoweron 3  
Powering on slot 3
```

## Equipment status

You can check the status of switch operation, High Availability features, and fabric connectivity.

### Checking switch operation

1. Connect to the switch and log in using an account assigned to the admin role.
2. Enter the **switchShow** command. This command displays a switch summary and a port summary.
3. Check that the switch and ports are online.
4. Use the **switchStatusShow** command to further check the status of the switch.

### Verifying High Availability features (directors and enterprise-class platforms only)

High Availability (HA) features provide maximum reliability and nondisruptive management of key hardware and software modules.

1. Connect to the switch and log in using an account assigned to the admin role.
2. Enter the **chassisShow** command to verify the model of the field-replaceable units (FRUs).
3. Enter the **haShow** command to verify HA is enabled, the heartbeat is up, and that the HA state is synchronized between the active and standby CP blades.
4. Enter the **fanShow** to display the current status and speed of each fan in the system. Refer to the hardware reference manual of your system to determine the appropriate values.
5. Enter the **psShow** to display the current status of the switch power supplies. Refer to the hardware reference manual of your system to determine the appropriate values.
6. Enter the **slotShow -m** command to display the inventory and the current status of each slot in the system.

#### Example of the slot information displayed for a DCX chassis

```
DCX:FID128:admin> slotshow -m
```

Slot	Blade Type	ID	Model Name	Status
1	SW BLADE	55	FC8-32	ENABLED
2	SW BLADE	51	FC8-48	ENABLED
3	SW BLADE	39	FC10-6	ENABLED
4	SW BLADE	51	FC8-48	ENABLED
5	CORE BLADE	52	CORE8	ENABLED
6	CP BLADE	50	CP8	ENABLED
7	CP BLADE	50	CP8	ENABLED
8	CORE BLADE	52	CORE8	ENABLED
9	SW BLADE	37	FC8-16	ENABLED
10	AP BLADE	43	FS8-18	ENABLED
11	SW BLADE	55	FC8-32	ENABLED
12	AP BLADE	24	FR4-18i	ENABLED

The possible fields and their values are outlined below.

Field	Value
Slot	Displays the physical slot number.
Blade Type	Displays the blade type. SW BLADE: The blade is a port blade. CP BLADE: The blade is a control processor. CORE BLADE: The blade is a core blade (Brocade DCX and DCX-4S only). AP BLADE: The blade is the FR4-18i blade. UNKNOWN: The blade is not present or its type is not recognized.
ID	Displays the hardware ID of the blade type. See <a href="#">Table 4</a> on page 44 for a list of blades and their corresponding IDs.
Model Name	Displays the model name of the blade.
Status	Displays the status of the blade. DIAG RUNNING POST1: The blade is present, powered on, and running the post-initialization power-on self test (POST). DIAG RUNNING POST2: The blade is present, powered on, and running the POST. ENABLED: The blade is on and enabled. DISABLED: The blade is powered on but disabled. FAULTY: The blade is faulty because an error was detected. The reason code numbers displayed are used by Support personnel to assist with problem diagnosis. Review the system error logs for more information. INITIALIZING: The blade is present, powered on, and initializing hardware components. INSERTED, NOT POWERED ON: The blade is present in the slot but is turned off. LOADING: The blade is present, powered on, and loading the initial configuration. POWERING UP: The blade is present and powering on. UNKNOWN: The blade is inserted but its state cannot be determined. VACANT: The slot is empty.

## Verifying fabric connectivity

1. Connect to the switch and log in using an account assigned to the admin role.
2. Enter the **fabricShow** command. This command displays a summary of all the switches in the fabric.

The output of the **fabricShow** command is discussed in [“Domain IDs”](#) on page 28.

## Verifying device connectivity

1. Connect to the switch and log in using an account assigned to the admin role.
2. *Optional:* Enter the **switchShow** command to verify devices, hosts, and storage are connected.
3. *Optional:* Enter the **nsShow** command to verify devices, hosts, and storage have successfully registered with the name server.

### 3 Track and control switch changes

4. Enter the **nsAllShow** command to display the 24-bit Fibre Channel addresses of all devices in the fabric.

```
switch:admin> nsallshow
{
  010e00 012fe8 012fef 030500 030b04 030b08 030b17 030b18
  030b1e 030b1f 040000 050000 050200 050700 050800 050de8
  050def 051700 061c00 071a00 073c00 090d00 0a0200 0a07ca
  0a07cb 0a07cc 0a07cd 0a07ce 0a07d1 0a07d2 0a07d3 0a07d4
  0a07d5 0a07d6 0a07d9 0a07da 0a07dc 0a07e0 0a07e1 0a0f01
  0a0f02 0a0f0f 0a0f10 0a0f1b 0a0f1d 0b2700 0b2e00 0b2fe8
  0b2fef 0f0000 0f0226 0f0233 0f02e4 0f02e8 0f02ef 210e00
  211700 211fe8 211fef 2c0000 2c0300 611000 6114e8 6114ef
  611600 620800 621026 621036 6210e4 6210e8 6210ef 621400
  621500 621700 621a00
  75 Nx_Ports in the Fabric }
```

The number of devices listed should reflect the number of devices that are connected.

## Track and control switch changes

The track changes feature allows you to keep a record of specific changes that may not be considered switch events, but may provide useful information. The output from the track changes feature is dumped to the system messages log for the switch. Use the **errDump** or **errShow** command to view the log.

Items in the log created from the Track changes feature are labeled *TRCK*.

Trackable changes are:

- Successful login
- Unsuccessful login
- Logout
- Configuration file change from task
- Track changes on
- Track changes off

An SNMP-TRAP mode can also be enabled (see the **trackChangesHelp** command in the *Fabric OS Command Reference*).

### Enabling the track changes feature

1. Connect to the switch and log in using an account assigned to the admin role.
2. Enter the **trackChangesSet 1** command to enable the track changes feature.

A message displays, verifying that the track changes feature is on:

```
switch:admin> trackchangesset 1
Committing configuration...done.
```

3. View the log using the commands **errDump | more** to display a page at a time or **errShow** to view one line at a time.

```
2008/10/10-08:13:36, [TRCK-1001], 5, FID 128, INFO, ras007, Successful login
by user admin.
```



## Displaying the status of the track changes feature

1. Connect to the switch and log in using an account assigned to the admin role.
2. Enter the **trackChangesShow** command.

The status of the track changes feature is displayed as either on or off. The display includes whether or not the track changes feature is configured to send SNMP traps.

```
switch:admin> trackchangesshow
Track changes status: ON
Track changes generate SNMP-TRAP: NO
```

## Viewing the switch status policy threshold values

The policy parameter determines the number of failed or inoperable units for each contributor that triggers a status change in the switch.

Each parameter can be adjusted so that a specific threshold must be reached before that parameter changes the overall status of a switch to MARGINAL or DOWN. For example, if the FaultyPorts DOWN parameter is set to 3, the status of the switch will change if three ports fail. Only one policy parameter needs to pass the MARGINAL or DOWN threshold to change the overall status of the switch.

For more information about setting policy parameters, see the *Fabric Watch Administrator's Guide*.

1. Connect to the switch and log in using an account assigned to the admin role.
2. Enter the **switchStatusPolicyShow** command.

Whenever there is a switch change, an error message is logged and an SNMP **connUnitStatusChange** trap is sent.

The output is similar to the following:

```
ecp:admin> switchstatuspolicyshow
The current overall switch status policy parameters:
          Down    Marginal
-----
PowerSupplies    3         0
Temperatures    2         1
    Fans         2         1
    WWN          0         1
    CP           0         1
    Blade        0         1
    CoreBlade    0         1
    Flash        0         1
MarginalPorts   112        44
FaultyPorts     112        44
MissingSFPs     0          0
```

## Setting the switch status policy threshold values

1. Connect to the switch and log in using an account assigned to the admin role.
2. Enter the **switchStatusPolicySet** command.

### 3 Track and control switch changes

The current switch status policy parameter values are displayed. You are prompted to enter values for each DOWN and MARGINAL threshold parameter.

---

**NOTE**

By setting the DOWN and MARGINAL values for a parameter to 0,0 that parameter is no longer used in setting the overall status for the switch.

---

3. Verify the threshold settings you have configured for each parameter.

Enter the **switchStatusPolicyShow** command to view your current switch status policy configuration.

**Example output from a switch**

The following example displays what is typically seen from a Brocade 300, 4100, 4900, 5000, 5410, 5424, 5450, 5460, 5470, 5480, 5100, 5300, 5424, 7500, 7500E, 7600, 7800, 8000, and a VA-40FC switch, but the quantity and types vary by platform.

```
switch:admin> switchstatuspolicyset
```

To change the overall switch status policy parameters

The current overall switch status policy parameters:

	Down	Marginal
PowerSupplies	3	0
Temperatures	2	1
Fans	2	1
WWN	0	1
CP	0	1
Blade	0	1
CoreBlade	0	1
Flash	0	1
MarginalPorts	112	44
FaultyPorts	112	44
MissingSFPs	0	0

Note that the value, 0, for a parameter, means that it is NOT used in the calculation.

\*\* In addition, if the range of settable values in the prompt is (0..0),

\*\* the policy parameter is NOT applicable to the switch.

\*\* Simply hit the Return key.

The minimum number of

```
Bad PowerSupplies contributing to DOWN status: (0..4) [3]
Bad PowerSupplies contributing to MARGINAL status: (0..4) [0]
Bad Temperatures contributing to DOWN status: (0..32) [2]
Bad Temperatures contributing to MARGINAL status: (0..32) [1]
Bad Fans contributing to DOWN status: (0..3) [2]
Bad Fans contributing to MARGINAL status: (0..3) [1]
Down WWN contributing to DOWN status: (0..2) [0]
Down WWN contributing to MARGINAL status: (0..2) [1]
Down CP contributing to DOWN status: (0..2) [0]
Down CP contributing to MARGINAL status: (0..2) [1]
Down Blade contributing to DOWN status: (0..8) [0]
Down Blade contributing to MARGINAL status: (0..8) [1]
Down CoreBlade contributing to DOWN status: (0..2) [0]
Down CoreBlade contributing to MARGINAL status: (0..2) [1]
Out of range Flash contributing to DOWN status: (0..1) [0]
```

```
Out of range Flash contributing to MARGINAL status: (0..1) [1]
MarginalPorts contributing to DOWN status: (0..1800) [112]
MarginalPorts contributing to MARGINAL status: (0..1800) [44]
FaultyPorts contributing to DOWN status: (0..1800) [112]
FaultyPorts contributing to MARGINAL status: (0..1800) [44]
MissingSFPs contributing to DOWN status: (0..576) [0]
MissingSFPs contributing to MARGINAL status: (0..576) [0]
No change
```

On the Brocade 48000, and Brocade DCX and DCX-4S enterprise-class platforms, the command output includes parameters related to CP blades.

## Audit log configuration

When managing SANs you may want to audit certain classes of events to ensure that you can view and generate an audit log for what is happening on a switch, particularly for security-related event changes. These events include login failures, zone configuration changes, firmware downloads, and other configuration changes—in other words—critical changes that have a serious effect on the operation and security of the switch.

Important information related to event classes is also tracked and made available. For example, you can track changes from an external source by the user name, IP address, or type of management interface used to access the switch.

Auditable events are generated by the switch and streamed to an external host through a configured system message log daemon (syslog). You specify a filter on the output to select the event classes that are sent through the system message log. The filtered events are streamed chronologically and sent to the system message log on an external host in the specified audit message format. This ensures that they can be easily distinguished from other system message log events that occur in the network. Then, at some regular interval of your choosing, you can review the audit events to look for unexpected changes.

Before you configure audit event logging, familiarize yourself with the following audit event log behaviors and limitations:

- By default, *all event classes* are configured for audit; to create an audit event log *for specific events*, you must explicitly set a filter with the *class* operand and then enable it.
- Audited events are generated specific to a switch and have no negative impact on performance.
- The last 256 events are persistently stored on the switch and are streamed to a system message log.
- The audit log depends on the system message log facility and IP network to send messages from the switch to a remote host. Because the audit event log configuration has no control over these facilities, audit events can be lost if the system message log and IP network facilities fail.
- If too many events are generated by the switch, the system message log becomes a bottleneck and audit events are dropped by the Fabric OS.
- If the user name, IP address, or user interface is not transported, *None* is used instead for each of the respective fields.
- For High Availability, the audit event logs exist independently on both active and standby CPs. The configuration changes that occur on the active CP are propagated to the standby CP and take effect.
- Audit log configuration is also updated through a configuration download.

## Auditable event classes

Before configuring an audit log, you must select the event classes you want audited. The audit log includes:

- SEC-3001 through SEC-3017
- SEC-3024 through SEC-3029
- ZONE-3001 through ZONE-3012

Table 7 identifies auditable event classes and the **auditCfg** command operands used to enable auditing of a specific class.

**TABLE 7** **auditCfg** event class operands

Operand	Event class	Description
1	Zone	Audit zone event configuration changes, but not the actual values that were changed. For example, a message may state, "Zone configuration has changed," but the syslog does not display the actual values that were changed.
2	Security	Audit any user-initiated security events for all management interfaces. For events that have an impact on an entire fabric, an audit is generated only for the switch from which the event was initiated.
3	Configuration	Audit configuration downloads of existing SNMP configuration parameters. Configuration uploads are not audited.
4	Firmware	Audit firmware download start, firmware complete, and any other errors encountered during a firmware download.
5	Fabric	Audit administrative domain-related changes.

### NOTE

Only the active CP can generate audit messages because event classes being audited occur only on the active CP. Audit messages cannot originate from other blades in an enterprise-class platform.

Audit events have the following message format:

```
AUDIT, <Timestamp>, [<Event ID>], <Severity>, <Event Class>, <User ID>/<Role>/<IP address>/<Interface>, <Admin Domain>/<Switch name>/<FID>, <Reserved>, <Event-specific information>
```

Switch names are logged for switch components and enterprise-class platform names for enterprise-class platform components. For example, an enterprise-class platform name may be FWDL or RAS and a switch component name may be zone, name server, or SNMP.

Pushed messages contain the administrative domain of the entity that generated the event. Refer to the *Fabric OS Message Reference* for details on message formats. For more information on setting up the system error log daemon, refer to the *Fabric OS Troubleshooting and Diagnostics Guide*.

## Verifying host syslog prior to configuring the audit log

Audit logging assumes that your syslog is operational and running. Before configuring an audit log, you must perform the following steps to ensure that the host syslog is operational.

1. Set up an external host machine with a system message log daemon running to receive the audit events that will be generated.
2. On the switch where the audit configuration is enabled, enter the **syslogdIpAdd** command to add the IP address of the host machine so that it can receive the audit events.  
  
You can use IPv4, IPv6, or DNS names for the **syslogdIpAdd** command.
3. Ensure the network is configured with a network connection between the switch and the remote host.
4. Check the host SYSLOG configuration. If all error levels are not configured, you may not see some of the audit messages.

## Configuring an audit log for specific event classes

1. Connect to the switch from which you want to generate an audit log and log in using an account assigned to the admin role.
2. Enter the **auditCfg --class** command, which defines the specific event classes to be filtered.

```
switch:admin> auditcfg --class 2,4
Audit filter is configured.
```

The **auditCfg** event class operands are identified in [Table 7](#) on page 60.

3. Enter the **auditCfg --enable** command, which enables audit event logging based on the classes configured in [step 2](#).

```
switch:admin> auditcfg --enable
Audit filter is enabled.
```

To disable an audit event configuration, enter the **auditCfg --disable** command.

4. Enter the **auditCfg --show** command to view the filter configuration and confirm that the correct event classes are being audited, and the correct filter state appears (enabled or disabled).

```
switch:admin> auditcfg --show
Audit filter is enabled.
2-SECURITY
4-FIRMWARE
```

5. Verify the audit event log setup by making a change affecting an enabled event class and confirming that the remote host machine receives the audit event messages.

### Example of the SYSLOG (system message log) output for audit logging

```
Oct 10 08:52:06 10.3.220.7 raslogd: AUDIT, 2008/10/10-08:20:19 (GMT),
[SEC-3020], INFO, SECURITY, admin/admin/10.3.220.13/telnet/CLI,
ad_0/ras007/FID 128, , Event: login, Status: success, Info: Successful login
attempt via REMOTE, IP Addr: 10.3.220.13.
```

```
Oct 10 08:52:23 10.3.220.7 raslogd: 2008/10/10-08:20:36, [CONF-1001], 13, WWN
10:00:00:05:1e:34:02:0c | FID 128, INFO, ras007, configUpload completed
successfully. All config parameters are uploaded.
```

```
Oct 10 09:00:04 10.3.220.7 raslogd: AUDIT, 2008/10/10-08:28:16 (GMT),
[SEC-3021], INFO, SECURITY, admin/NONE/10.3.220.13/None/CLI, None/ras007/FID
128, , Event: login, Status: failed, Info: Failed login attempt via REMOTE, IP
Addr: 10.3.220.13.
```

### 3 Audit log configuration

# Routing Traffic

---

## About this chapter

• Routing overview . . . . .	63
• Inter-switch links . . . . .	66
• Gateway links . . . . .	69
• Inter-chassis links . . . . .	71
• Routing policies . . . . .	73
• Route selection . . . . .	76
• Frame order delivery . . . . .	78
• Lossless Dynamic Load Sharing on ports . . . . .	79
• Frame Redirection . . . . .	81

## Routing overview

Data moves through a fabric from switch to switch and from storage to server along one or more paths that make up a *route*. Routing policies determine the path for each frame of data.

Before the fabric can begin to route, it must discover the route a packet should take to reach the intended destination. Route tables are lists that indicate the next hop to which packets are directed to reach a destination. Route tables include network addresses, the next address in the data path, and a cost to reach the destination network. There are two kinds of routing protocols on intranet networks, Distance Vector and Link State.

- Distance Vector is based on hop count. This is the number of switches that a frame passes through to get from the source switch to the destination switch.
- Link State is based on a metric value based on a cost. The cost could be based on bandwidth, line speed, or round-trip-time.

With the link-state method, switches that discover a route identify the networks to which they are attached, receiving an initial route table from the principal switch. After an initial message is sent out, the switch only notifies the others when changes occur.

It is recommended that no more than seven hops occur between any two switches. This limit is not required or enforced by FSPF. Its purpose is to ensure that a frame is not delivered to a destination after R\_A\_TOV has expired.

Unicast, multicast, and broadcast traffic are supported. Both Unicast Class 2 and 3 traffic are supported. Broadcast and multicast are supported in Class 3 only.

## Path versus route selection

Paths are possible ways to get from one switch to another. Each Inter-Switch Link (ISL) has a metric cost based on bandwidth. The cumulative cost is based on the sum of all costs of all traversed ISLs.

Route selection is the path that is chosen. Paths that are selected from the routing database are chosen based on the minimal cost.

## FSPF

Fabric Shortest Path First (FSPF) is a link state path selection protocol that directs traffic along the shortest path between the source and destination based upon the link cost. FSPF is also referred to as Layer 2 routing. FSPF detects link failures, determines the shortest route for traffic, updates the routing table, provides fixed routing paths within a fabric, and maintains correct ordering of frames. FSPF keeps track of the state of the links on all switches in the fabric and associates a cost with each link. The protocol computes paths from a switch to all the other switches in the fabric by adding the cost of all links traversed by the path, and chooses the path that minimizes the costs. This collection of the link states, including costs, of all the switches in the fabric constitutes the topology database or link state database. Once established, FSPF programs the hardware routing tables for all active ports on the switch. FSPF is not involved in frame switching. FSPF uses several frames to perform its functions. Since it may run before fabric routing is set up, FSPF does not use the routing tables to propagate the frames, but floods the frames throughout the fabric hop-by-hop. Frames are first flooded on all the ISLs; as the protocol progresses, it builds a spanning tree rooted on the Principal Switch. Frames are only sent on the Principal ISLs that belong to the spanning tree. When there are multiple ISLs between switches, the first ISL to respond to connection requests becomes the Principal ISL. Only one ISL from each switch will be used as the Principal ISL. [Figure 5](#) shows the thicker red lines as principal ISLs, and thinner green lines as regular ISLs.

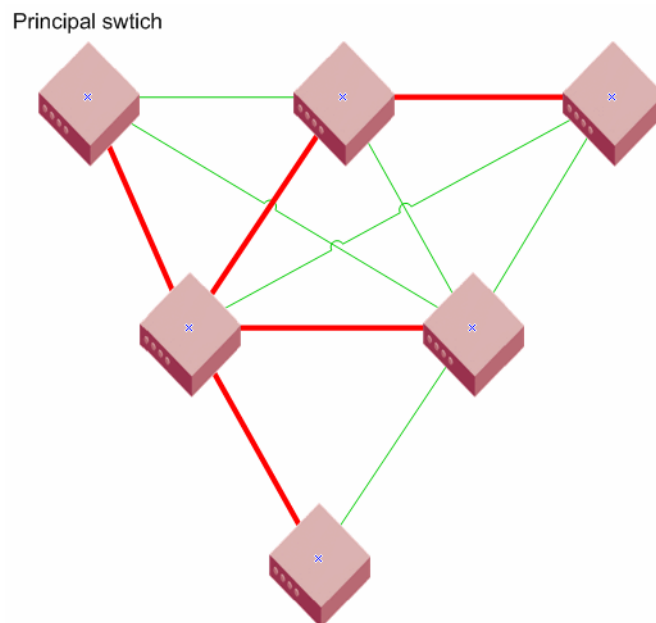

**FIGURE 5** Principal ISLs

---

### ATTENTION

FSPF only supports 16 ISLs in a zone, including Traffic Isolation Zones.

---



FSPF makes minimal use of the ISL bandwidth, leaving virtually all of it available for traffic. In a stable fabric, a switch transmits 64 bytes every 20 seconds in each direction. FSPF frames have the highest priority in the fabric. This guarantees that a control frame is not delayed by user data and that FSPF routing decisions occur very quickly during convergence.

FSPF guarantees a routing loop free topology at all times. It is essential for a fabric to include many physical loops because without loops there would be no multiple paths between switches, and therefore no redundancy. If a link went down, part of the fabric becomes isolated. FSPF ensures that the topology is loop free and that the frame is never forwarded over the same ISL more than once.

FSPF calculates paths based on the destination domain ID. The fabric protocol must complete domain ID assignments before routing can begin. ISLs provide the physical pathway when the Source ID (SID) address has a frame destined to a port on a remote switch Destination ID (DID). When an ISL is attached or removed from a switch, the FSPF updates the route tables to reflect the addition or deletion of the new routes.

As each host transmits a frame to the switch, the switch reads the SID and DID in the frame header. If the domain ID of the destination address is the same as the switch (intra-switch communications), the frame buffer is copied to the destination port and a credit R\_RDY is sent to the host. The switch only needs to read word zero and word one of the Fibre Channel frame to perform what is known as cut-through routing. A frame may begin to emerge from the output port before it has been entirely received by the input port. The entire frame does not need to be buffered in the switch.

If the destination domain ID is different than the source domain ID, then the switch consults the FSPF route table to identify which local E\_Port provides the Fabric Shortest Path First to the remote domain.

## Fibre Channel NAT

Within an edge fabric or across a backbone fabric, the standard Fibre Channel fabric shortest path first (FSPF) protocol determines how frames are routed from the source Fibre Channel device to the destination FC device. The source or destination device can be a proxy device.

Fibre Channel fabrics require that all ports be identified by a unique PID. In a single fabric, FC protocol guarantees that domain IDs are unique, and so a PID formed by a domain ID and area ID is unique within a fabric. However, the domain IDs and PIDs in one fabric may be duplicated within another fabric, just as IP addresses that are unique to one private network are likely to be duplicated within another private network.

In an IP network, a network router can maintain network address translation (NAT) tables to replace private network addresses with public addresses when a packet is routed out of the private network, and to replace public addresses with private addresses when a packet is routed from the public network to the private network. The Fibre Channel routing equivalent to this IP-NAT is the Fibre Channel network address translation (FC-NAT). Using FC-NAT, the proxy devices in a fabric can have PIDs that are different from the real devices they represent, allowing the proxy devices to have appropriate PIDs for the address space of their corresponding fabric.

## Inter-switch links

An inter-switch link (ISL) is a link between two switches, E\_Port-to-E\_Port. The ports of the two switches automatically come online as E\_Ports, once the login process finishes successfully. For more information on the login process refer to [Chapter 1, “Understanding Fibre Channel Services”](#).

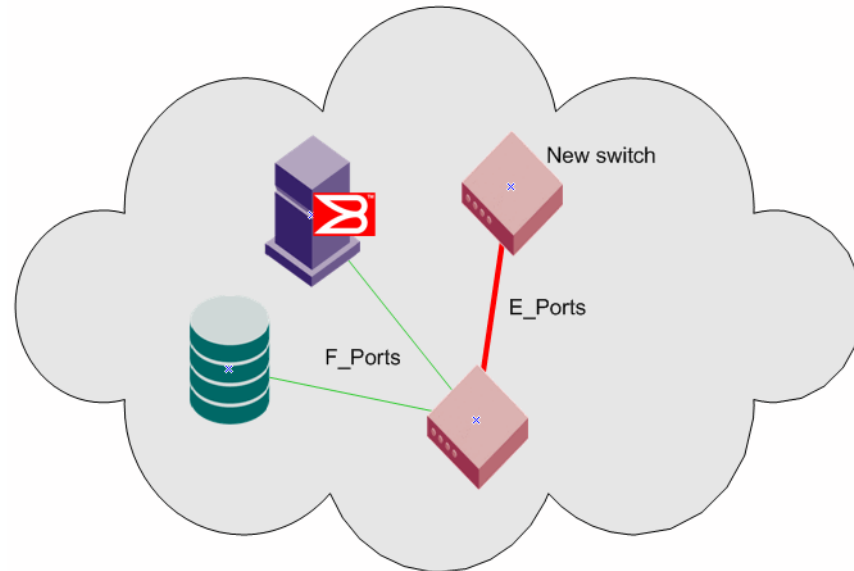

**FIGURE 6** New switch added to existing fabric

You can connect new switches to existing switches and this expands your fabric. [Figure 6](#) shows a new switch being added into an existing fabric. The thicker red line is the newly formed ISL. When connecting two switches together, you need to verify that the following parameters are different:

- Domain ID
- Switch name
- Chassis name

You must also verify the following fabric parameters are identical on each switch for a fabric to merge:

- R\_A\_TOV
- E\_D\_TOV
- Data field size
- Sequence level switching
- Disable device probing
- Suppress class F traffic
- Per-frame route priority
- BB credit
- PID format

There are non-fabric parameters that must match as well, such as zoning. Some fabric services, such as Management Server must match. If it is enabled in the fabric, then the switch you are introducing into the fabric must also have it enabled. If you experience a segmented fabric, refer to the *Fabric OS Troubleshooting and Diagnostics Guide* to fix the problem.

## Buffer credits

In order to prevent the dropping of frames in the fabric, a device can never send frames without the receiving device being able to receive them, so an end-to-end flow control is used on the switch. Flow control in Fibre Channel uses buffer-to-buffer credits which are distributed by the switch. When all buffer-to-buffer credits are utilized, a device will wait for a VC\_RDY or an R\_RDY primitive from the destination switch before resuming I/O. The primitive is dependent on whether you have R\_RDYs enabled on your switch using the **portCfgISLMode** command. When a device logs into a fabric, it typically requests anywhere from two to sixteen buffer credits from the switch, depending on device type, driver version, and configuration. This determines the maximum number of frames the port may transmit before receiving an acknowledgement from the receiving device.

For more information on how to set the buffer-to-buffer credits on an extended link, refer to [Chapter 20, "Managing Long Distance Fabrics"](#).

## Virtual Channels

Virtual channels create multiple logical data paths across a single physical link or connection. They are allocated their own network resources such as queues and buffer-to-buffer credits. Virtual channel technology is the fundamental building block used to construct Adaptive Networking services. For more information on Adaptive Networking services, refer to [Chapter 18, "Optimizing Fabric Behavior"](#).

Virtual channels are divided into three priority groups. P1 is the highest which is used for Class F, F\_RJT, and ACK traffic. P2 is the next highest which is used for data frames. The data virtual channels can be further prioritized to provide higher levels of Quality of Service. P3 is the lowest and is used for broadcast and multicast traffic.

## 4 Inter-switch links

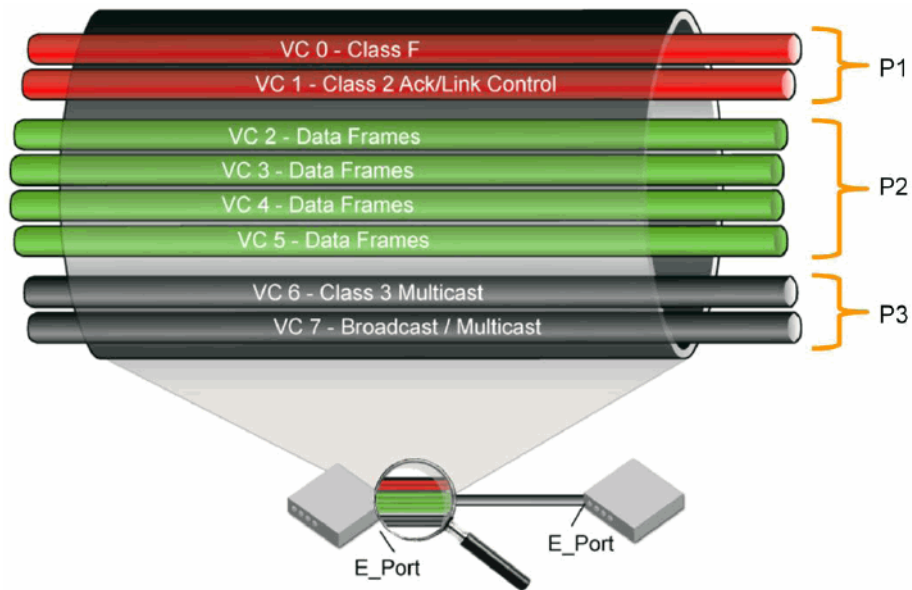

**FIGURE 7** Virtual Channels on a 1/2/4 Gbps ISL

Quality of Service (QoS) is a licensed traffic shaping feature available in Fabric OS. QoS allows the prioritization of data traffic based on the SID/DID of each frame. Through the use of QoS zones, traffic can be divided into three priorities: high, medium, and low. The seven data VC channels, VC8-14, are used to multiplex data frames based upon QoS Zones when congestion occurs. For more information on QoS zones refer to [Chapter 18, "Optimizing Fabric Behavior"](#).

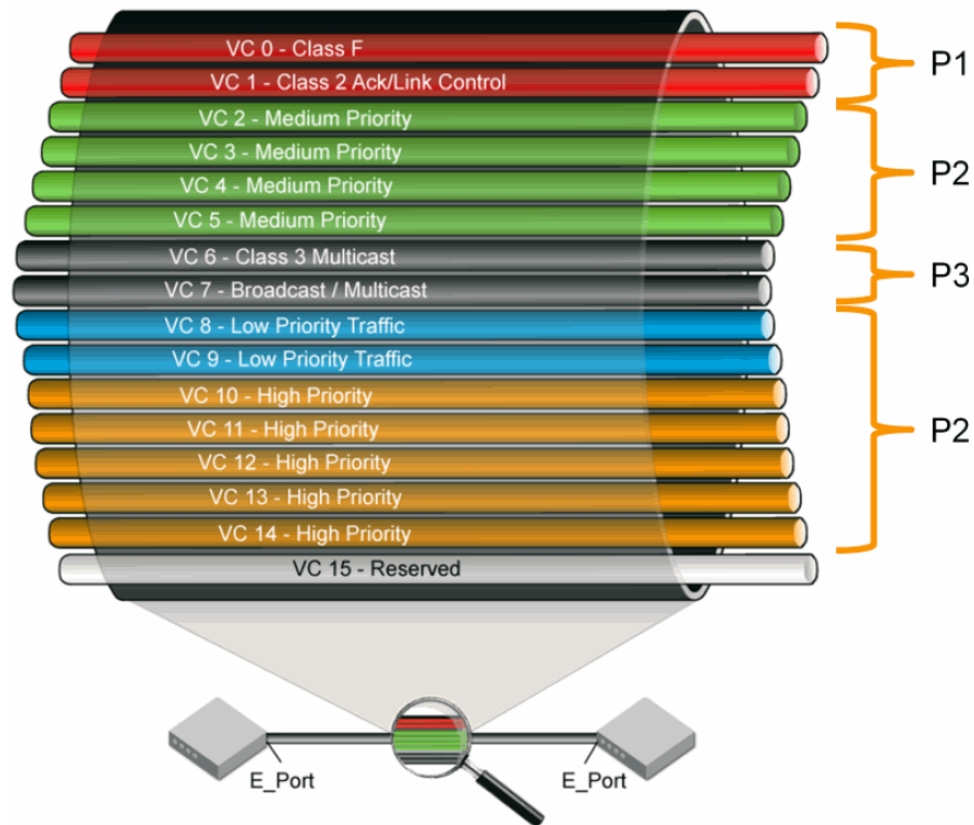
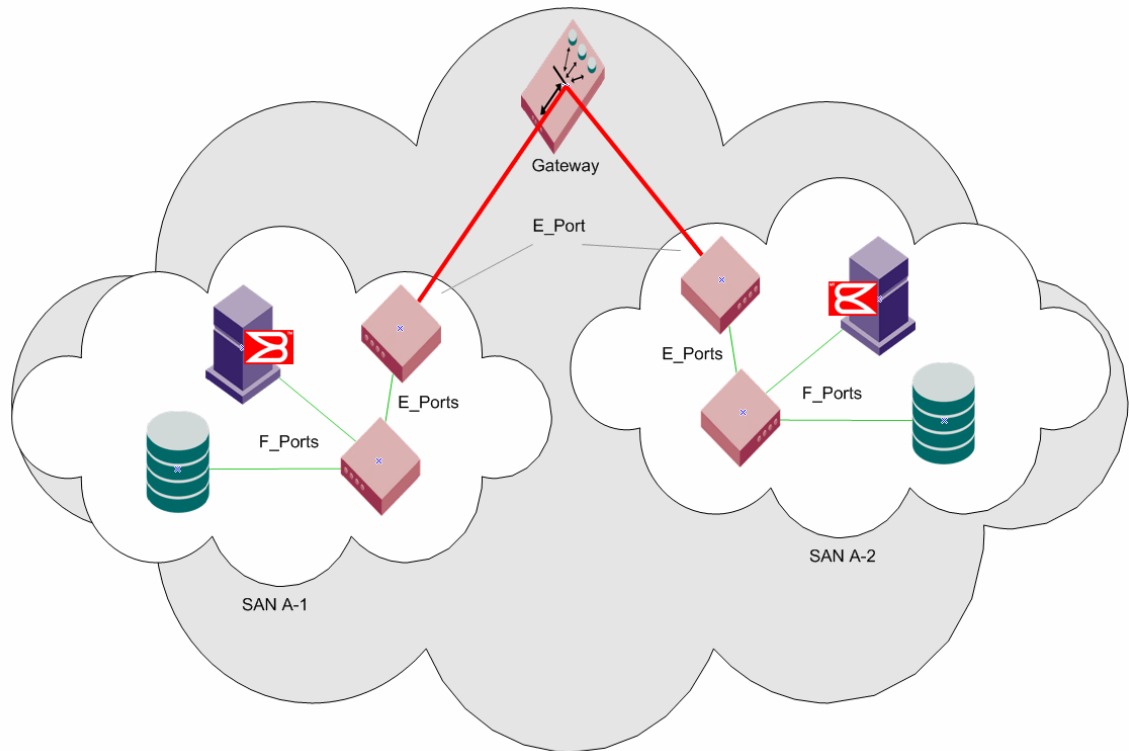

FIGURE 8 Virtual Channels on an 8 Gbps ISL

## Gateway links

A gateway merges SANs into a single fabric by establishing point-to-point E\_Port connectivity between two Fibre Channel switches that are separated by a network with a protocol such as IP or SONET.

Except for link initialization, gateways are transparent to switches; the gateway simply provides E\_Port connectivity from one switch to another. [Figure 9](#) shows two separate SANs, A-1 and A-2, merged together using a gateway.



**FIGURE 9** Gateway link merges SAN

By default, switch ports initialize links using the Exchange Link Parameters (ELP) mode 1. However, gateways expect initialization with ELP mode 2, also referred to as ISL R\_RDY mode. Therefore, to enable two switches to link through a gateway, the ports on both switches must be set for ELP mode 2.

Any number of E\_Ports in a fabric can be configured for gateway links, provided the following guidelines are followed:

- All switches in the fabric are using the core PID format, as described in [“Configuring a link through a gateway”](#) on page 70.
- The switches connected to both sides of the gateway are included when determining switch count maximums.
- Extended links (those created using the Extended Fabrics licensed feature) are not supported through gateway links.

### Configuring a link through a gateway

1. Connect to the switch at one end of the gateway and log in using an account assigned to the admin role.
2. Enter the `portCfgIsiMode` command.
3. Repeat steps 1 through 2 for any additional ports that will be connected to the gateway.
4. Repeat this procedure on the switch at the other end of the gateway.

**Example of enabling a gateway link on slot 2, port 3.**

```

ecp:admin> portcfgislmode 2/3, 1
Committing configuration...done.
ISL_R_RDY Mode is enabled for port 3. Please make sure the PID
formats are consistent across the entire fabric.

```

## Inter-chassis links

An Inter-chassis link (ICL) is a licensed feature used to interconnect two Brocade DCX Backbones, two Brocade DCX-4S, or a Brocade DCX and a Brocade DCX-4S Backbone. ICL ports in the core blades are used to interconnect two Brocade Backbones, potentially increasing the number of usable ports in the Brocade DCX or DCX-4S chassis. The ICL ports on CORE8 and CR4S-8 blades are internally managed as E\_Ports. These ports use proprietary connectors instead of traditional SFPs. When two Brocade Backbones are interconnected by ICLs, each chassis still requires a unique domain and is managed as a separate switch.

On the Brocade DCX there are two ICL connectors at ports ICL0 and ICL1 on each core blade, each aggregating a set of 16 ports. Thus, each core blade provides 32 ICL ports and there are 64 ICL ports available for the entire Brocade DCX chassis. All the ICL connector ports must be connected to the same two Brocade DCX or DCX-4S chassis.

The Brocade DCX-4S has 2 ICL connector ports at ICL0 and ICL1, each aggregating a set of 8 ports. Thus, each core blade provides 16 ICL ports and there are 32 ICL ports available for the entire Brocade DCX-4S chassis. All the ICL connector ports must be connected to the same two Brocade DCX or DCX-4S chassis.

Only cross ICL group connections are allowed:

- ICL0 <--> ICL1
- ICL1 <--> ICL0

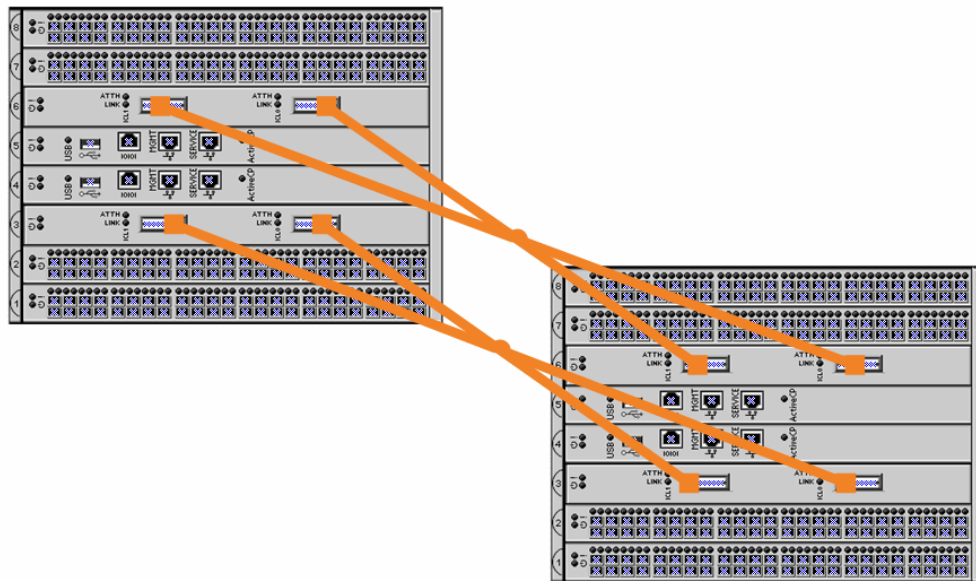

FIGURE 10 DCX-4S allowed ICL connections

The following ICL connections are not allowed:

- ICLO <--> ICLO
- ICL1 <--> ICL1

Refer to the *Brocade DCX Data Center Backbone Hardware Reference Manual* for detailed ICL connection information.

ICL ports can be used only with an ICL license. For more information on how license enforcement occurs, see [Chapter 16, “Administering Licensing”](#). After the addition or removal of a license, the license enforcement is performed on the ICL ports only when you issue the **portDisable** or **portEnable** commands on the switch for the ports. All ICL ports must be disabled, and then re-enabled for the license to take effect. An ICL license must be installed on both platforms forming the ICL connection.

There are two LEDs — a status LED and an attention LED — for each ICL connector port. The following table describes the behavior of the LEDs.

**TABLE 8 LED behavior**

LED	Color	Description	Action
Status	Black	No connection with peer blade.	NA
	Green	ICL connection with peer blade is good.	NA
Attention	Black	ICL is fully operational.	NA
	Blinking Yellow	One or more links in the ICL connection is NOT operational.	Reconnect the ICL cables or replace the ICL cables.

The ICL ports appear as regular ports, with some restrictions. All port parameters associated with ICL ports are static and all **portCfg** commands are blocked from changing any of the ICL port parameters. The only management associated with ICL ports and cables is monitoring the status of the LEDs on the ICL ports and any maintenance if the ATTENTION LED is blinking yellow. For additional information about the LED status for blades and ports, see the *Brocade DCX Hardware Installation manual*.

When you connect two Brocade Backbones, the following features are supported:

- 8 Gbps speed
- Trunking
- Buffer-to-buffer credit sharing
- QoS

### Supported topologies

The triangular topology is supported between three Brocade DCX or DCX-4S chassis. On an ICL break the chassis that has the connections of the other two, is the main chassis. Any error messages relating to a break in the topology will appear in this chassis' RASlog.



If one ICL is broken but there is a regular ISL, the triangular topology still holds given the ISL cost is lower than the total cost through the ICL linear topology. If a direct ICL link between two switches is broken the triangular topology is considered broken when the ISL path between the two switches is a multiple hop. In this case the triangular topology broken message will still be posted independent of the cost of the ISL path being lesser or greater than the ICL path between the two switches. Refer to the *Brocade DCX Backbone Hardware Reference Manual* and the *Brocade DCX-4S Backbone Hardware Reference Manual* for instructions on how to cable ICLs.

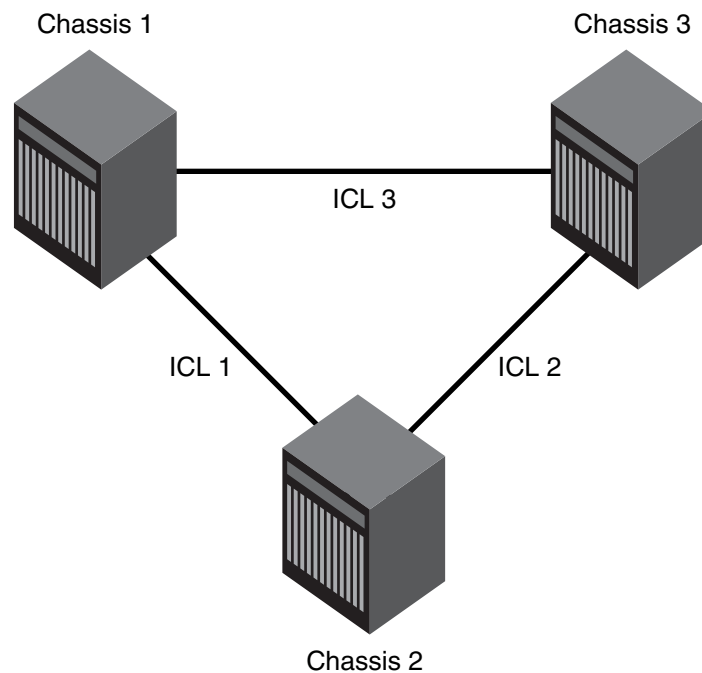

**FIGURE 11** ICL triangular topology

**Virtual Fabrics considerations:** In Virtual Fabrics, the ICL ports can be split across the logical switch, base switch and default switch. The triangular topology requirement still needs to be met for each fabric individually. The present restriction on ICL being part of only logical switches with “Allow XISL Use” attribute off still applies.

## Routing policies

By default, all routing protocols place their routes into a routing table. You can control the routes that a protocol places into each table and the routes from that table that the protocol advertises by defining one or more routing policies and then applying them to the specific routing protocol.

The routing policy is responsible for selecting a route based on one of two user-selected routing policies:

- Port-based routing
- Exchange-based routing

On the Brocade 300, 4100, 4900, 5000, 5410, 5424, 5450, 5460, 5470, 5480, 5100, 5300, 5424, 7500, 7500E, 7600, 7800, 8000, and VA-40FC switches, the Brocade 48000 director, and the Brocade DCX and DCX-4S enterprise-class platforms (all 4 Gbps ASICs and later) routing is handled by the FSPF protocol and either the port-based routing or exchange-based routing policies.

Each switch can have its own routing policy and different policies can exist in the same fabric.

---

### ATTENTION

For most configurations, the default routing policy is optimal and provides the best performance. You should change the routing policy only if there is a performance issue that is of concern, or if a particular fabric configuration or application requires it.

---

## Displaying the current routing policy

1. Connect to the switch and log in as admin.
2. Enter the **aptPolicy** command with no parameters.

The current policy is displayed, followed by the supported policies for the switch.

### Example of the output from the aptPolicy command.

In the following example, the current policy is exchange-based routing (3) with the additional AP dedicated link policy.

```
switch:admin> aptpolicy
Current Policy: 3 1(ap)

3 0(ap): Default Policy
1: Port Based Routing Policy
3: Exchange Based Routing Policy
    0: AP Shared Link Policy
    1: AP Dedicated Link Policy
```

## Exchange-based routing

The choice of routing path is based on the Source ID (SID), Destination ID (DID), and Fibre Channel originator exchange ID (OXID), optimizing path utilization for the best performance. Thus, every exchange can take a different path through the fabric. Exchange-based routing requires the use of the Dynamic Load Sharing (DLS) feature; when this policy is in effect, you cannot disable the DLS feature.

Exchange-based routing is also known as Dynamic Path Selection (DPS). DPS is where exchanges or communication between end-devices in a fabric are assigned to egress ports in ratios proportional to the potential bandwidth of the ISL or trunk group. When there are multiple paths to a destination, the input traffic will be distributed across the different paths in proportion to the bandwidth available on each of the paths. This improves utilization of the available paths, thus reducing possible congestion on the paths. Every time there is a change in the network (which changes the available paths), the input traffic can be redistributed across the available paths. This is a very easy and non-disruptive process when the exchange-based routing policy is engaged.

## Port-based routing

The choice of routing path is based only on the incoming port and the destination domain. To optimize port-based routing, DLS can be enabled to balance the load across the available output ports within a domain.

Using port-based routing, you can assign a static route, in which the path chosen for traffic does not change when a topology change occurs unless the path becomes unavailable. If the static route violates FSPF, it is not used. In contrast, exchange-based routing policies always employ dynamic path selection.

---

**NOTE**

**For FC routers only:** When an FC router is in port-based routing mode, the backbone traffic is load-balanced based on SID and DID. When an FC router is in exchange-based routing mode, the backbone traffic is load-balanced based on SID, DID, and OXID.

---

Whatever routing policy a switch is using applies to the VE\_Ports as well. For more information on VE\_Ports, refer to the *Fibre Channel over IP Administrator's Guide*.

## AP route policy

On the Brocade 7500 switch and FR4-18i blade, eight internal physical links are used by EX\_ and VEX\_Port functionality. The links are shared by both ingress and egress traffic on EX\_ and VEX\_Ports. The AP (appliance) route policy dedicates some links for ingress traffic and some links for egress traffic.

The AP Dedicated Link Policy relieves internal congestion in an environment where:

- There is a large amount of traffic going through both directions at the same time.
- There is a reduction of the effect of slow devices on the overall switch performance.

It is recommended that the default AP Shared Link Policy be used for most environments. Also, it is recommended that you design a SAN that localizes Host to Target traffic by reducing the amount of traffic through the router. Two additional AP policies are supported under exchange-based routing:

- AP Shared Link policy (default)
- AP Dedicated Link policy

The AP policies are independent of the routing policies. Every routing policy supports both AP policies.

---

**ATTENTION**

Setting this policy is a disruptive process.

---

## Routing in Virtual Fabrics

Virtual Fabrics support DPS on all partitions. DPS is limited where multiple paths are available for a logical fabric frame entering a Virtual Fabric chassis from a base fabric that is sent out using one of the dedicated ISLs in a logical switch.

The AP policy affecting the DPS behavior, whether it is exchange-based, device-based, or port-based, is configured on a per logical switch basis. IOD and DLS settings are set per logical switch as well. IOD and DLS settings for the base switch affect all traffic going over the base fabric including any logical fabric traffic that uses the base fabric.

**CAUTION**

**Setting the routing policy is disruptive to the fabric because it requires that you disable the switch where the routing policy is being changed.**

---

### *Setting the routing policy*

1. Connect to the switch and log in as admin.
2. Enter the **switchDisable** command to disable the switch.
3. Take the appropriate following action based on the route policy you choose to implement:
  - If Exchange-based policy is required, enter the **aptPolicy 3** command.
  - If Port-based policy is required, enter the **aptPolicy 1** command.

### *Setting up the AP route policy*

1. Connect to the switch and log in as admin.
2. Enter the **switchDisable** command to disable the switch.
3. Take the appropriate following action based on the route policy you choose to implement:
  - If AP Shared Link policy (default) is required, enter the **aptPolicy -ap 0** command.
  - If AP Dedicated Link policy is required, enter the **aptPolicy -ap 1** command.

## Route selection

Selection of specific routes can be dynamic, so that the router can constantly adjust to changing network conditions; or it may be static, so that data packets always follow a predetermined path.

### Dynamic Load Sharing

The exchange-based routing policy depends on the Fabric OS Dynamic Load Sharing feature (DLS) for dynamic routing path selection. When using the exchange-based routing policy, DLS is enabled by default and cannot be disabled. In other words, you cannot enable or disable DLS when the exchange-based routing policy is in effect.

When the port-based policy is in force, you can enable DLS to optimize routing. When DLS is enabled, it shares traffic among multiple equivalent paths between switches. DLS recomputes load sharing when any of the following occurs:

- a switch boots up
- an E\_Port goes offline and online
- an EX\_Port goes offline
- a device goes offline

### *Setting DLS*

1. Connect to the switch and log in as admin.
2. Enter the **dlsShow** command to view the current DLS setting.

One of the following messages appears:

- “DLS is set” indicates that dynamic load sharing is turned on.
- “DLS is not set” indicates that dynamic load sharing is turned off.

- "DLS is set with Lossless enabled." DLS is enabled with the Lossless feature. Load sharing is recomputed with every change in the fabric, and existing routes can be moved to maintain optimal balance. In Lossless mode, no framers are lost during this operation.
- "DLS is set by default with current routing policy. DLS is set with Lossless enabled." Indicates that the current routing policy (exchange-based) requires DLS to be enabled by default. In addition, the lossless option is enabled. Frame loss is prevented during a load sharing re-computation. If you get this message, you cannot perform [step 3](#), so you are done with this procedure.

3. Enter the **dlsSet** command to enable DLS or enter the **dlsReset** command to disable it.

#### Example of setting and resetting DLS.

```
switch:admin> dlsshow
DLS is not set
switch:admin> dlsset
switch:admin> dlsshow
DLS is set
switch:admin> dlsreset
switch:admin> dlsshow
DLS is not set
```

## Static route assignment

A static route can be assigned only when the active routing policy is port-based routing. When exchange-based routing is active, you cannot assign static routes.

Static routes are supported only on the Brocade 4100 and 5000 platforms.

Static routes are not supported on the Brocade 300, 4900, 5410, 5424, 5450, 5460, 5470, 5480, 5100, 5300, 5424, 7500, 7500E, 7600, 7800, 8000, and VA-40FC switches, and the Brocade 48000 or Brocade DCX or DCX-4S enterprise-class platforms. Instead, use the traffic isolation feature to create a dedicated path for interswitch traffic. See "[Traffic Isolation Zoning](#)" on page 267 for information about this feature.

### *Assigning a static route*

1. Connect to the switch and log in as admin.
2. Enter the **uRouteConfig** command.

#### Example of configuring a route

The following example shows how to configure a static route for all traffic coming in from port 1 and addressed to domain 2 to go through port 5:

```
switch:admin> urouteconfig 1 2 5
done.
```

### *Removing a static route*

1. Connect to the switch and log in as admin.
2. Enter the **uRouteRemove** command.

## Frame order delivery

The order of delivery of frames is maintained within a switch and determined by the routing policy in effect. The frame delivery behaviors for each routing policy are:

- Port-based routing  
All frames received on an incoming port destined for a destination domain are guaranteed to exit the switch in the same order in which they were received.
- Exchange-based routing  
All frames received on an incoming port for a given exchange are guaranteed to exit the switch in the same order in which they were received. Because different paths are chosen for different exchanges, this policy does not maintain the order of frames across exchanges.

If even one switch in the fabric delivers out-of-order exchanges, then exchanges are delivered to the target out-of-order, regardless of the policy configured on other switches in the fabric.

---

### NOTE

Some devices do not tolerate out-of-order exchanges; in such cases, use the port-based routing policy.

---

In a stable fabric, frames are always delivered in order, even when the traffic between switches is shared among multiple paths. However, when topology changes occur in the fabric (for example, if a link goes down), traffic is rerouted around the failure, and some frames could be delivered out of order. Most destination devices tolerate out-of-order delivery, but some do not.

By default, out-of-order frame-based delivery is allowed to minimize the number of frames dropped. Enabling in-order delivery (IOD) guarantees that frames are either delivered in order or dropped. You should only force in-order frame delivery across topology changes if the fabric contains destination devices that cannot tolerate occasional out-of-order frame delivery.

## Forcing in-order frame delivery across topology changes

1. Connect to the switch and log in as admin.
2. Enter the **iodSet** command.

---

### NOTE

This command can cause a delay in the establishment of a new path when a topology change occurs; use it with care.

---

3. Confirm the in-order delivery has been set by entering the **iodShow** command.

## Restoring out-of-order frame delivery across topology changes

1. Connect to the switch and log in as admin.
2. Enter the **iodReset** command.

## Lossless Dynamic Load Sharing on ports

Lossless Dynamic Load Sharing (DLS) allows you to rebalance port paths without causing input/output (I/O) failures. For devices where In-Order Delivery (IOD) of frames is required, you can set IOD separately. You can use this feature with the Brocade300, 5100, 5300, and VA-40FC switches, and the FC8-16/32/64/48 port blades, the FC8-32 and FX8-18 application blades in the Brocade DCX and DCX-4S enterprise-class platforms. On the Brocade 7800 switch and the FX8-24 application blade, Lossless DLS is supported only on FC to FC port flows.

---

### ATTENTION

When you implement Lossless DLS, the switches in the fabric must all have either Fabric OS v6.3.0 or they must all have Fabric OS v6.4.0 installed to guarantee no frame loss.

---

Lossless DLS must be implemented along the path between the target and initiator. You can use Lossless DLS on ports connecting switches to perform the following functions:

- Eliminate dropped frames and I/O failures by rebalancing the paths going over the ISLs whenever there is a fabric event that might result in suboptimal utilization of the ISLs.
- Eliminate the frame delay caused by establishing a new path when a topology change occurs.

Lossless mode means no frame loss during a rebalance and only takes effect if DLS is enabled. Lossless DLS can be enabled on fabric topology in order to have zero frame drops during rebalance operations. If the end device also requires the order of frames to be maintained during the rebalance operation then IOD needs to be enabled. However this combination of Lossless DLS and IOD is supported only in specific topologies, such as in a FICON environment.

You can disable or enable IOD when Lossless DLS is enabled. You can also choose between exchange- or port-based policies with Lossless DLS. Events that cause a rebalance include the following:

- Adding an E-port.
- Adding a slave E-port.
- Removing an E-port, however frame loss will occur on traffic flows to this port.
- Removing an F-port, however frame loss will occur on traffic flows to this port.

Lossless DLS does the following whenever paths need to be rebalanced:

- Pauses ingress traffic by not returning credits. Frames that are already in transit are not dropped.
- Change the existing path to a more optimal path.

#### If IOD is enabled

- Wait for sufficient time for frames already received to be transmitted. This is needed to maintain IOD.
- Resume traffic.

[Table 9](#) shows the effect of frames when you have a specific routing policy turned on with IOD.

**TABLE 9** Combinations of routing policy and IOD with Lossless DLS enabled

Policy	IOD	Rebalance result with Lossless DLS enabled
Port-based	Disabled	No frame loss, but out of order frames may occur.
Port-based	Enabled	No frame loss and no out of order frames. Topology restrictions apply. Intended for FICON environment.

**TABLE 9 Combinations of routing policy and IOD with Lossless DLS enabled (Continued)**

Policy	IOD	Rebalance result with Lossless DLS enabled
Exchange-based	Disabled	No frame loss, but out of order frames may occur.
Exchange-based	Enabled	No frame loss and no out of order frames. Topology restrictions apply. Intended for FICON environment.

## Lossless core

Lossless core works with the default configuration of the Brocade DCX and DCX-4S to prevent frame loss during a core blade removal and insertion. This feature is on by default and cannot be disabled. Lossless core has the following limitations:

- Only supported with IOD disabled which means Lossless core cannot guarantee in-order delivery of exchanges.
- ICL limitations.
- Traffic flow limitations.

### *ICL Limitations*

If ICL ports are connected during a core blade removal, then it is equivalent to removing external E\_Ports which cause I/O disruption on the ICL ports that have been removed.

If ICL ports are connected during a core blade insertion, then it is equivalent to adding external E\_Ports which may cause I/O disruption due to reroutes. Lossless DLS, if enabled, takes effect to prevent I/O disruption.

### *Traffic flow limitations*

The FA4-18 and FR4-18i AP blades, which are supported on the Brocade DCX and DCX-4S, may continue to experience frame drops after core blade removal or insertion. The path between an FC10-6, FA4-18, and FR4-18i blade and an FX8-24 blade, or vice-versa, will experience I/O disruption because the FC10-6, FA4-18, and FR4-18i blades do not support this feature.

## Configuring Lossless Dynamic Load Sharing

You configure Lossless DLS switch- or chassis-wide by using the **dlsSet** command to specify that no frames are dropped while rebalancing or rerouting traffic.

1. Connect to the switch and log in using an account assigned to the admin role.
2. Enter the appropriate **dlsSet** command to enable or disable Lossless Dynamic Load Sharing.

```
switch:admin>dlsset --enable lossLess
switch:admin>dlsset --disable lossLess
```

## Lossless Dynamic Load Sharing in Virtual Fabrics

Enabling Lossless Dynamic Load Sharing is optional on logical switches in a Virtual Fabric. If you enable this feature, it must be on a per logical switch basis and can affect other logical switches in the fabric. XISL use must be disabled for Lossless DLS to be enabled



**Example of how DLS affects other logical switches in the fabric**

On a Brocade DCX platform, logical switch 1 consists of ports 0 through 5 in slot 1. Logical switch 2 consists of ports 6–10 in slot 1. The Lossless DLS feature is enabled on logical switch 1. Because ports 0–10 in slot 1 belong to a logical switch where Lossless DLS is turned on, the traffic in logical switch 2 is affected whenever traffic for logical switch 1 is rebalanced.

---

**ATTENTION**

Although, this feature is enabled for a specific logical switch, you must have chassis-level permissions to use this feature.

---

This effect on logical switch 2 is based on the configuration on logical switch 2:

- If logical switch 2 has IOD enabled (**iodSet** only), then IOD is enforced.
- If logical switch 2 has Lossless DLS enabled, then traffic will be paused and resumed.
- If logical switch 2 has no IOD (**iodReset**), traffic will be paused and resumed.

To avoid this behavior, it is recommended to define your logical switches as follows:

- Define logical switches that require Lossless DLS at the blade boundary.
- Define logical switches that require Lossless DLS only using supported blades. For example, do not use blades that support IOD, but do not support Lossless DLS.

For more information on Virtual Fabrics and chassis-level permissions, see the [“Managing Virtual Fabrics”](#) chapter.

---

**NOTE**

Downgrading from Fabric OS v6.2.0 is not supported if Lossless DLS is enabled.

If you have Lossless DLS is enabled, but DLS, IOD and port-based are not enabled, and since Fabric OS v6.3.0 does not support this combination, the downgrade fails.

---

## Frame Redirection

Frame Redirection provides a means to redirect traffic flow between a host and a target that use virtualization and encryption applications, such as SAS and DMM, so that those applications can perform without having to reconfigure the host and target. You can use this feature if the hosts and targets are not directly attached.

Frame Redirection depends on the wide distribution of the Defined Zone Database. The Defined Database on Fabric OS switches is pushed out to all other Fabric OS switches in the fabric that support Frame Redirection. RD zones exist only in the defined configuration and cannot be added to the effective configuration.

Frame Redirection uses a combination of special frame redirection zones and Name Server changes to spoof the mapping of real device WWNs to Virtual PIDs.

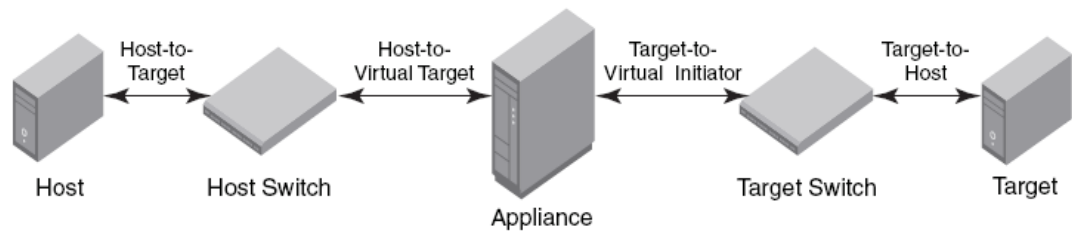

**FIGURE 12** Single Host and Target

Figure 12 demonstrates the flow of frame redirection traffic. A frame starts at the host with a destination to the target. The port where the appliance is attached to the host switch acts as the virtual initiator and the port where the appliance is attached to the target switch is the virtual target.

## Creating a frame redirect zone

The first time this command is run the following zone objects are created by default:

- The base zone object, "red\_\_\_\_\_base".
  - The RD zone configuration, "r\_e\_d\_i\_r\_c\_\_fg".
1. Connect to the switch and log in using an account assigned to the admin role.
  2. Enter the **zone --rdcreate** command.
  3. Enter the **cfgSave** command to save the frame redirect zones to the defined configuration.

### Example of creating a frame redirect zone.

The following example creates an RD Zone, given a host (10:10:10:10:10:10:10:10), target (20:20:20:20:20:20:20:20), VI (30:30:30:30:30:30:30:30), and VT (40:40:40:40:40:40:40:40):

```
switch:admin>zone --rdcreate 10:10:10:10:10:10:10:10 20:20:20:20:20:20:20:20 \
30:30:30:30:30:30:30:30 40:40:40:40:40:40:40:40 restartable noFCR
```

## Deleting a frame redirect zone

1. Connect to the switch and log in using an account assigned to the admin role.
2. Enter the **zone --rdDelete** command to remove the base RD zone, "red\_\_\_\_\_base".  
When the base zone is removed, the RD zone configuration "r\_e\_d\_i\_r\_c\_\_fg" is removed as well.
3. Enter the **zone --cfgSave** command to save changes to the defined configuration.

### Example of deleting a frame redirect zone.

```
switch:admin> zone --rddelete \
red_0917_10_10_10_10_10_10_10_10_20_20_20_20_20_20_20_20
```

## Viewing redirect zones

1. Connect to the switch and log in using an account assigned to the admin role.
2. Enter the **cfgShow** command.

# Managing User Accounts

---

## In this chapter

- [User accounts overview](#) ..... 83
- [Local database user accounts](#) ..... 88
- [Local account database distribution](#) ..... 90
- [Password policies](#) ..... 91
- [The boot PROM password](#) ..... 95
- [The authentication model using RADIUS and LDAP](#) ..... 99

## User accounts overview

In addition to the default accounts—root, factory, admin, and user—Fabric OS supports up to 252 additional user-defined accounts in each logical switch (domain). These accounts expand your ability to track account access and audit administrative activities.

Each user-defined account is associated with the following:

- Admin Domain list — Specifies the Administrative Domains a user account is allowed to log in to.
- Home Admin Domain — Specifies the Admin Domain that the user is logged in to by default. The home Admin Domain must be a member of the user’s Admin Domain list.
- Role — Determines functional access levels within the bounds of the user’s current Admin Domain.
- Virtual Fabric list — Specifies the Virtual Fabric a user account is allowed to log in to.
- Home Virtual Fabric — Specifies the Virtual Fabric that the user is logged in to by default. The home Virtual Fabric must be a member of the user’s Virtual Fabric list.
- LF Role List — Determines functional access levels within the bounds of the user’s Virtual Fabrics.

---

### NOTE

Admin Domains are mutually exclusive from Virtual Fabrics permissions when setting up user accounts. You will need to set up different user accounts for each feature.

You cannot have Admin Domain mode and Virtual Fabrics mode enabled at the same time.

---

For more information about Admin Domains, refer to [Chapter 15, “Managing Administrative Domains”](#).

For more information about Virtual Fabrics, refer to refer to [Chapter 10, “Managing Virtual Fabrics”](#).

Fabric OS provides three options for authenticating users—remote RADIUS services, remote LDAP service, and the local switch user database. All options allow users to be centrally managed using the following methods:

- **Remote RADIUS server:** Users are managed in a remote RADIUS server. All switches in the fabric can be configured to authenticate against the centralized remote database.
- **Remote LDAP server:** Users are managed in a remote LDAP server. All switches in the fabric can be configured to authenticate against the centralized remote database.
- **Local user database:** Users are managed using the local user database. The local user database is manually synchronized using the **distribute** command to push a copy of the switch's local user database to all other Fabric OS v5.3.0 and later switches in the fabric.

## Role-Based Access Control (RBAC)

Role-Based Action Control (RBAC) defines the capabilities that a user account has based on the role the account has been assigned. For each role, there is a set of predefined permissions on the jobs and tasks that can be performed on a fabric and its associated fabric elements. Fabric OS uses RBAC to determine which commands a user can issue.

When you log in to a switch, your user account is associated with a predefined role. The role that your account is associated with determines the level of access you have on that switch and in the fabric. The chassis-role permission is not a role like the other role types, but a permission that is applied to a user account. You can use the **userConfig** command to add this permission to a user account. For clarity, this permission has been added to [Table 10](#), which outlines the Fabric OS predefined roles.

**TABLE 10** Fabric OS roles

Role name	Duties	Description
Admin	All administration	All administrative commands excluding chassis-specific commands.
BasicSwitchAdmin	Restricted switch administration	Mostly monitoring with limited switch (local) commands.
FabricAdmin	Fabric and switch administration	All switch and fabric commands, excludes user management and Admin Domains commands.
Operator	General switch administration	Routine switch maintenance commands.
SecurityAdmin	Security administration	All switch security and user management functions.
SwitchAdmin	Local switch administration	Most switch (local) commands, excludes security, user management, and zoning commands.
User	Monitoring only	Nonadministrative use, such as monitoring system activity.
ZoneAdmin	Zone administration	Zone management commands only.

**Admin Domain considerations:** Legacy users with no Admin Domain specified and their current role is admin will have access to AD 0 through 255 (physical fabric admin); otherwise, they will have access to ADO only.

If some Admin Domains have been defined for the user and all of them are inactive, the user will not be allowed to log in to any switch in the fabric. If no Home Domain is specified for a user, the system provides a default home domain.

The default home domain for the predefined account is ADO. For user-defined accounts, the default home domain is the Admin Domain in the user's Admin Domain list with the lowest ID.

## Role permissions

Table 11 describes the types of permissions that are assigned to roles.

**TABLE 11** Permission types

Abbreviation	Definition	Description
O	Observe	The user can run commands using options that display information only, such as running <code>userConfig --show -a</code> to show all users on a switch.
M	Modify	The user can run commands using options that create, change, and delete objects on the system, such as running <code>userConfig --change username -r rolename</code> to change a user's role.
OM	Observe and Modify	The user can run commands using both observe and modify options; if a role has modify permissions, it almost always has observe.
N	None	The user is not allowed to run commands in a given category.

Table 12 shows the permission type for categories of commands that each role is assigned. The permissions apply to all commands within the specified category. For a complete list of commands and role permissions, see the *Fabric OS Command Reference*.

**TABLE 12** RBAC permissions matrix

Category	Role permission								
	Admin	Basic Switch Admin	Fabric Admin	Operator	Security Admin	Switch Admin	User	Zone Admin	
Admin Domains	OM	N	N	N	O	N	N	N	
Admin Domains—Selection	OM	OM	OM	OM	OM	OM	OM	OM	
Access Gateway	OM	O	O	OM	N	OM	O	O	
APM	OM	O	OM	O	N	OM	O	N	
Audit	OM	O	O	O	OM	O	O	O	
Authentication	OM	N	N	N	OM	N	N	N	
Blade	OM	O	OM	OM	N	OM	O	N	
Converged Enhanced Ethernet (FCoE)	OM	O	OM	O	O	O	O	O	
Chassis Configuration <sup>1</sup>	OM	O	OM	OM	N	OM	O	N	
Chassis Management <sup>2</sup>	OM	O	OM	OM	N	N	O	N	
Configure	OM	O	O	O	OM	O	N	O	
Configuration Management	OM	O	O	O	O	O	N	O	
Data Migration Manager	OM	N	N	N	N	N	N	N	
DCE	OM	N	OM	N	O	O	O	N	
Debug	N	N	N	N	N	N	N	N	
Diagnostics	OM	O	OM	OM	N	OM	O	N	
Encryption Configuration	OM	N	O	N	OM	N	N	N	

**TABLE 12 RBAC permissions matrix (Continued)**

Category	Role permission							
	Admin	Basic Switch Admin	Fabric Admin	Operator	Security Admin	Switch Admin	User	Zone Admin
Encryption Management	OM	N	OM	N	O	N	N	N
Ethernet Configuration	OM	O	OM	O	N	OM	O	N
Fabric	OM	O	OM	O	O	O	O	O
Fabric Distribution	OM	N	OM	N	OM	N	N	N
Fabric Routing	OM	O	OM	O	O	O	O	O
Fabric Watch	OM	O	OM	OM	N	OM	O	N
FICON	OM	O	OM	OM	N	OM	O	N
FIPS Bootprom	N	N	N	N	N	N	N	N
FIPS Configuration	OM	N	N	N	OM	N	N	N
Firmware Key Management	OM	O	O	O	OM	O	O	O
Firmware Management	OM	O	OM	OM	OM	OM	O	O
FRU Management	OM	O	OM	OM	N	OM	O	N
HA (High Availability)	OM	O	OM	O	O	OM	O	N
IPsec Management	OM	O	O	O	OM	O	N	N
iSCSI	OM	O	OM	O	N	O	O	O
License	OM	O	OM	OM	O	OM	O	O
LDAP	OM	N	N	N	OM	OM	N	N
Local User Environment	OM	OM	OM	OM	OM	OM	OM	OM
Logging	OM	O	OM	OM	OM	OM	O	O
Management Access Configuration	OM	O	OM	OM	N	OM	O	N
Management Server	OM	O	OM	OM	N	OM	O	O
Name Server	OM	O	OM	O	N	OM	O	O
Nx_Port Management	OM	O	OM	OM	N	OM	O	N
Physical Computer System	O	O	O	O	O	O	O	O
PKI	OM	O	O	O	OM	O	O	N
Port Mirroring	OM	N	N	N	N	N	N	N
QoS	OM	OM	OM	OM	O	OM	O	O
RADIUS	OM	N	N	N	OM	N	N	N
Reboot	OM	O	OM	OM	OM	OM	O	O
Routing—Advanced	OM	O	OM	O	N	O	O	N
Routing—Basic	OM	O	OM	OM	N	OM	O	O
Security	OM	O	OM	N	OM	O	O	N
Session Management	OM	OM	OM	OM	OM	OM	O	N

**TABLE 12** RBAC permissions matrix (Continued)

Category	Role permission							
	Admin	Basic Switch Admin	Fabric Admin	Operator	Security Admin	Switch Admin	User	Zone Admin
SNMP	OM	O	OM	O	OM	OM	O	N
Statistics	OM	O	OM	OM	N	OM	O	N
Statistics—Device	OM	O	OM	OM	N	OM	O	N
Statistics—Port	OM	O	OM	OM	N	OM	O	N
Switch Configuration	OM	O	OM	OM	OM	OM	O	O
Switch Management	OM	O	OM	OM	O	OM	O	O
Switch Management—IP Configuration	OM	O	OM	OM	OM	OM	O	N
Switch Port Configuration	OM	OM	OM	OM	O	OM	O	O
Switch Port Management	OM	OM	OM	OM	O	OM	O	O
Topology	OM	O	OM	O	N	O	O	N
USB Management	OM	N	N	N	OM	N	N	N
User Management	OM	N	N	N	OM	N	N	N
WWN Card	OM	N	OM	OM	N	OM	O	N
Zoning	OM	O	OM	O	O	O	O	OM

1. Only with the chassis role permission added to the user's admin role account.
2. Only with the chassis role permission added to the user's admin role account.

## The management channel

The management channel is the communication established between the management workstation and the switch. [Table 13](#) shows the number of simultaneous login sessions allowed for each role when authenticated locally. The roles are displayed in alphabetic order which does not reflect their importance. When authenticating using LDAP or RADIUS, the total number of sessions on a switch may not exceed 32.

**TABLE 13** Maximum number of simultaneous sessions

Role name	Maximum sessions
Admin	2
BasicSwitchAdmin	4
FabricAdmin	4
Operator	4
SecurityAdmin	4
SwitchAdmin	4
User	4
ZoneAdmin	4

## Local database user accounts

User **add**, **change**, and **delete** operations are subject to the *subset* rule: an admin with ADlist 0-10 or LFlist 1-10 cannot perform operations on an *admin*, *user*, or *any* role with an ADlist 11-25 or LFlist 11-128. The user account being changed must have an ADlist or LFlist that is a subset of the account that is making the change.

In addition to the default administrative and user accounts, Fabric OS supports up to 252 user-defined accounts in each logical switch (domain). These accounts expand your ability to track account access and audit administrative activities.

### Default accounts

Table 14 lists the predefined accounts offered by Fabric OS available in the local switch user database. The password for all default accounts should be changed during the initial installation and configuration for each switch.

**TABLE 14** Default local user accounts

Account name	Role	Admin Domain	Logical Fabric	Description
admin	Admin	ADO-255 home: 0	LF1-128 home: 128	Most commands have <i>observe-modify</i> permission.
factory	Factory	ADO-255 home: 0	LF1-128 home: 128	Reserved.
root	Root	ADO-255 home: 0	LF1-128 home: 128	Reserved.
user	User	ADO home: 0	LF-128 home: 128	Most commands have <i>observe-only</i> permission.

**Admin Domain and Virtual Fabric considerations:** Administrators can act on other accounts only if that account has an Admin Domain or Logical Fabric list that is a subset of the administrator.

### Displaying account information

1. Connect to the switch and log in using an account assigned to the admin role.
2. Enter the appropriate **show** operands for the account information you want to display:
  - **userConfig --show -a** to show all account information for a logical switch
  - **userConfig --show username** to show account information for the specified account
  - **userConfig --showad -a adminDomain\_ID** to show all accounts permitted to select the specified adminDomain\_ID
  - **userConfig --showlf -l logicalFabric\_ID** for each LF in an LF\_ID\_list, displays a list of users that include that LF in their LF permissions.

### Creating an account

1. Connect to the switch and log in using an account assigned to the admin role.
2. Enter the **userConfig --add** command.
3. In response to the prompt, enter a password for the account.

The password is not displayed when you enter it on the command line.



### *Deleting an account*

This procedure can be performed on local user accounts.

1. Connect to the switch and log in using an account assigned to the admin role.
2. Enter the **userConfig --delete** command.

---

**NOTE**

You cannot delete the default accounts. An account cannot delete itself. All active CLI sessions for the deleted account are logged out.

---

3. At the prompt for confirmation, enter **y**.

### *Changing account parameters*

This procedure can be performed on local user accounts.

When changing account parameters, if you change the ADlist for the user account, all of the currently active sessions for that account will be logged out. For more information about changing the Admin Domain on an account, refer to [Chapter 15, “Managing Administrative Domains”](#).

1. Connect to the switch and log in using an account assigned to the admin role.
2. Enter the **userConfig --change** command.

## Local account passwords

The following rules apply to changing passwords:

- Users can change their own passwords.
- Only users with Admin roles can change the password for another account. When changing an Admin account password, you must provide the current password.
- An admin with ADlist 0-10 or LFlist 1-10 cannot change the password on an *admin*, *user*, or *any* role with an ADlist 11-25 or LFlist 11-128. The user account being changed must have an ADlist that is a subset of the account that is making the change.
- A new password must have at least one character different from the old password.
- You cannot change passwords using SNMP.

### *Changing the password for the current login account*

1. Connect to the switch and log in.
2. Enter the **passwd** command.
3. Enter the requested information at the prompts.

### *Changing the password for a different account*

1. Connect to the switch and log in using an account assigned to the admin role.
2. Enter the **passwd** command specifying the name of the account for which the password is being changed.
3. Enter the requested information at the prompts.

## Local account database distribution

Fabric OS allows you to distribute the user database and passwords to other switches in the fabric. When the switch accepts a distributed user database, it replaces the local user database with the user database it receives.

By default, switches accept the user databases and passwords distributed from other switches. The 'Locked' status of a user account is not distributed as part of local user database distribution.

When distributing the user database, the database may be rejected by a switch for one of the following reasons:

- One of the target switches does not support local account database distribution.
- One of the target switch's user database is protected.
- One of the remote switches has logical switches defined.

### Distributing the local user database

When distributing the local user database, all user-defined accounts residing in the receiving switches are logged out of any active sessions.

1. Connect to the switch and log in using an account assigned to the admin role.
2. Enter the **distribute -p PWD -d** command.

---

#### NOTE

If Virtual Fabrics mode is enabled and there are logical switches defined other than the default logical switch, then distributing the password database to switches is not supported.

If the **distribute** command is issued from a pre-Fabric OS v6.2.0, switches running Fabric OS v6.2.0 or later will reject it.

---

### Accepting distribution of user databases on the local switch

1. Connect to the switch and log in using an account assigned to the admin role.
2. Enter the **fddCfg --localaccept PWD** command.

### Rejecting distributed user databases on the local switch

1. Connect to the switch and log in using an account assigned to the admin role.
2. Enter the **fddCfg --localreject PWD** command.

## Password policies

The password policies described in this section apply to the local switch user database only. Configured password policies (and all user account attribute and password state information) are synchronized across CPs and remain unchanged after an HA failover. Password policies can also be manually distributed across the fabric (see [“Local account database distribution”](#) on page 90). Following is a list of the configurable password policies:

- Password strength
- Password history
- Password expiration
- Account lockout

All password policies are enforced during logins to the standby CP. However, you may observe that the password enforcement behavior on the standby CP is inconsistent with prior login activity because password state information from the active CP is automatically synchronized with the standby CP, thereby overwriting any password state information that was previously stored there. Also, password changes are not permitted on the standby CP.

Password authentication policies configured using the `passwdCfg` command are *not* enforced during initial prompts to change default passwords.

### Password strength policy

The password strength policy is enforced across all user accounts, and enforces a set of format rules to which new passwords must adhere. The password strength policy is enforced only when a new password is defined. The total of the other password strength policy parameters (lowercase, uppercase, digits, and punctuation) must be less than or equal to the value of the `MinLength` parameter.

Use the following attributes to set the password strength policy:

- Lowercase  
Specifies the minimum number of lowercase alphabetic characters that must appear in the password. The default value is zero. The maximum value must be less than or equal to the `MinLength` value.
- Uppercase  
Specifies the minimum number of uppercase alphabetic characters that must appear in the password. The default value is zero. The maximum value must be less than or equal to the `MinLength` value.
- Digits  
Specifies the minimum number of numeric digits that must appear in the password. The default value is zero. The maximum value must be less than or equal to the `MinLength` value.
- Punctuation  
Specifies the minimum number of punctuation characters that must appear in the password. All printable, non-alphanumeric punctuation characters except the colon ( : ) are allowed. The default value is zero. The maximum value must be less than or equal to the `MinLength` value.

- **MinLength**  
Specifies the minimum length of the password. The minimum can be from 8 to 40 characters. New passwords must be between the minimum length specified and 40 characters. The default value is 8. The maximum value must be greater than or equal to the MinLength value.
- **Repeat**  
Specifies the length of repeated character sequences that will be disallowed. For example, if the “repeat” value is set to 3, a password “passAAAword” is disallowed because it contains the repeated sequence “AAA”. A password of “passAAword” would be allowed because no repeated character sequence exceeds two characters. The range of allowed values is 1 – 40. The default value is 1.
- **Sequence**  
Specifies the length of sequential character sequences that will be disallowed. A sequential character sequence is defined as a character sequence in which the ASCII value of each contiguous character differs by one. The ASCII value for the characters in the sequence must all be increasing or decreasing. For example, if the “sequence” value is set to 3, a password “passABCword” is disallowed because it contains the sequence “ABC”. A password of “passABword” would be allowed because it contains no sequential character sequence exceeding two characters. The range of allowed values is 1 – 40. The default value is 1.

### Example of a password strength policy

The following example shows a password strength policy that requires passwords to contain at least 3 uppercase characters, 4 lowercase characters and 2 numeric digits; the minimum length of the password is 9 characters.

```
passwdcfg --set -uppercase 3 -lowercase 4 -digits 2 -minlength 9
```

## Password history policy

The password history policy prevents users from recycling recently used passwords, and is enforced across all user accounts when users are setting their own passwords. The password history policy is enforced only when a new password is defined.

Specify the number of past password values that are disallowed when setting a new password. Allowable password history values range between 0 and 24. If the value is set to 0, it means that the new password cannot be set to current password, but can be set to 1 previous password. The default value is 1, which means the current and one previous password cannot be reused. The value 2 indicates that the current and the two previous passwords cannot be used (and so on, up to 24 passwords).

This policy does not verify that a new password meets a minimal standard of difference from prior passwords, rather, it only determines whether or not a newly-specified password is identical to one of the specified number (1-24) of previously used passwords.

The password history policy is not enforced when an administrator sets a password for another user; instead, the user’s password history is preserved and the password set by the administrator is recorded in the user’s password history.

## Password expiration policy

The password expiration policy forces expiration of a password after a configurable period of time, and is enforced across all user accounts. A warning that password expiration is approaching is displayed when the user logs in. When a user's password expires, he or she must change the password to complete the authentication process and open a user session. You can specify the number of days prior to password expiration during which warnings will commence. Password expiration does not disable or lock out the account.

Use the following attributes to set the password expiration policy:

- **MinPasswordAge**  
Specifies the minimum number of days that must elapse before a user can change a password. MinPasswordAge values range from 0 to 999. The default value is zero. Setting this parameter to a non-zero value discourages users from rapidly changing a password in order to circumvent the password history setting to select a recently-used password. The MinPasswordAge policy is not enforced when an administrator changes the password for another user.
- **MaxPasswordAge**  
Specifies the maximum number of days that can elapse before a password must be changed, and is also known as the password expiration period. MaxPasswordAge values range from 0 to 999. The default value is zero. Setting this parameter to zero disables password expiration.
- **Warning**  
Specifies the number of days prior to password expiration that a warning about password expiration is displayed. Warning values range from 0 to 999. The default value is 0 days.

---

**NOTE**

When MaxPasswordAge is set to a non-zero value, MinPasswordAge and Warning must be set to a value that is less than or equal to MaxPasswordAge.

---

## Account lockout policy

The account lockout policy disables a user account when that user exceeds a specified number of failed login attempts, and is enforced across all user accounts. You can configure this policy to keep the account locked until explicit administrative action is taken to unlock it, or the locked account can be automatically unlocked after a specified period. Administrators can unlock a locked account at any time.

A failed login attempt counter is maintained for each user on each switch instance. The counters for all user accounts are reset to zero when the account lockout policy is enabled. The counter for an individual account is reset to zero when the account is unlocked after a lockout duration period expires.

The admin account can also have the lockout policy enabled on it. The admin account lockout policy is disabled by default and uses the same lockout threshold as the other roles. It can be automatically unlocked after the lockout duration passes or when it is manually unlocked by either a user account that has a securityAdmin or other Admin role.

**Virtual Fabric considerations:** The home logical fabric context is used to validate user enforcement for the account lockout policy.

The following commands are used to manage the account lockout policy.

- `userConfig --change account_name -u`
- `passwdCfg --disableadminlockout`

Note that the account-locked state is distinct from the account-disabled state.

Use the following attributes to set the account lockout policy:

- **LockoutThreshold**  
Specifies the number of times a user can attempt to log in using an incorrect password before the account is locked. The number of failed login attempts is counted from the last successful login. LockoutThreshold values range from 0 to 999, and the default value is 0. Setting the value to 0 disables the lockout mechanism.
- **LockoutDuration**  
Specifies the time, in minutes, after which a previously locked account is automatically unlocked. LockoutDuration values range from 0 to 99999, and the default value is 30. Setting the value to 0 disables lockout duration, and would require a user to seek administrative action to unlock the account. The lockout duration begins with the first login attempt after the LockoutThreshold has been reached. Subsequent failed login attempts do not extend the lockout period.

### *Enabling the admin lockout policy*

1. Log in to the switch using an account that is an Admin role or securityAdmin role.
2. Enter the `passwdCfg --enableadminlockout` command.

### *Unlocking an account*

1. Log in to the switch using an account that is an Admin role or securityAdmin role.
2. Enter the `userConfig --change account_name -u` command specifying the name of the user account that is locked out.

### *Disabling the admin lockout policy*

1. Log in to the switch using an account that is an Admin role or securityAdmin role.
2. Enter the `passwdCfg --disableadminlockout` command.

### *Denial of service implications*

The account lockout mechanism may be used to create a denial of service condition by repeatedly attempting to log in to an account using an incorrect password. Selected privileged accounts are exempted from the account lockout policy to prevent them from being locked out from a denial of service attack. However these privileged accounts may then become the target of password guessing attacks. Audit logs should be examined to monitor if such attacks are attempted.

## The boot PROM password

The boot PROM password provides an additional layer of security by protecting the boot PROM from unauthorized use. Setting a recovery string for the boot PROM password enables you to recover a lost boot PROM password by contacting your switch service provider. Without the recovery string, a lost boot PROM password cannot be recovered.

Although you can set the boot PROM password without also setting the recovery string, it is strongly recommended that you set both the password and the recovery string. If your site procedures dictate that you set the boot PROM password without the recovery string, see [“Setting the boot PROM password for a switch without a recovery string”](#) on page 97.

To set the boot PROM password with or without a recovery string, refer to the section that applies to your switch model or enterprise-class platform.



### CAUTION

**Setting the boot PROM password requires accessing the boot prompt, which stops traffic flow through the switch until the switch is rebooted. Perform this procedure during a planned downtime.**

## Setting the boot PROM password for a switch with a recovery string

This procedure applies to the following switch models: Brocade 300, 4100, 4900, 5000, 5410, 5424, 5450, 5460, 5470, 5480, 5100, 5300, 7500, 7500E, 7600, 7800 and 8000 switches. If your switch is not listed, please contact your switch support provider for instructions.

1. Connect to the serial port interface as described in [“Connecting to Fabric OS through the serial port”](#) on page 16.
2. Reboot the switch.
3. Press **ESC** within four seconds after the message “Press escape within 4 seconds...” displays.

The following options are available:

Option	Description
1 Start system.	Continues the system boot process.
2 Recovery password.	Lets you set the recovery string and the boot PROM password.
3 Enter command shell.	Provides access to boot parameters.

4. Enter **2**.

- If no password was previously set, the following message displays:

```
Recovery password is NOT set. Please set it now.
```

- If a password was previously set, the following messages display:

```
Send the following string to Customer Support for password recovery:
afHTpyLsDolPz0Pk5GzhIw==
Enter the supplied recovery password.
Recovery Password:
```

5. Enter the recovery password (string).

The recovery string must be between 8 and 40 alphanumeric characters. A random string that is 15 characters or longer is recommended for higher security. The firmware prompts for this password only once. It is not necessary to remember the recovery string because it is displayed the next time you enter the command shell.

The following prompt displays:

```
New password:
```

6. Enter the boot PROM password, then re-enter it when prompted. The password must be eight alphanumeric characters (any additional characters are not recorded). Record this password for future use.

The new password is automatically saved.

7. Reboot the switch by typing the **reset** command at the prompt.

### Setting the boot PROM password for a director with a recovery string

This procedure applies to the following enterprise-class platforms: Brocade 48000 director and Brocade DCX and DCX-4S Data Center Backbones.

The boot PROM and recovery passwords must be set for each CP blade on Brocade 48000, Brocade DCX and DCX-4S enterprise-class platforms.

1. Connect to the serial port interface on the standby CP blade, as described in [“Connecting to Fabric OS through the serial port”](#) on page 16.
2. Connect to the active CP blade by serial or Telnet and enter the **haDisable** command to prevent failover during the remaining steps.
3. Reboot the standby CP blade by sliding the On/Off switch on the ejector handle of the standby CP blade to Off, and then back to On.
4. Press **ESC** within four seconds after the message “Press escape within 4 seconds...” displays.

The following options are available:

Option	Description
1	Start system. Continues the system boot process.
2	Recovery password. Lets you set the recovery string and the boot PROM password.
3	Enter command shell. Provides access to boot parameters.

5. Enter **2**. Take the following appropriate action based on whether you find the password was previously set:

- If no password was previously set, the following message displays:

```
Recovery password is NOT set. Please set it now.
```

- If a password was previously set, the following messages display:

```
Send the following string to Customer Support for password recovery:  
afHTpyLsDo1Pz0Pk5GzhIw==  
Enter the supplied recovery password.  
Recovery Password:
```

6. Enter the recovery password (string).



The recovery string must be between 8 and 40 alphanumeric characters. A random string that is 15 characters or longer is recommended for higher security. The firmware only prompts for this password once. It is not necessary to remember the recovery string because it is displayed the next time you enter the command shell.

The following prompt displays:

```
New password:
```

7. Enter the boot PROM password, then re-enter it when prompted. The password must be eight alphanumeric characters (any additional characters are not recorded). Record this password for future use.

The new password is automatically saved (the **saveEnv** command is not required).

8. Connect to the active CP blade using serial or Telnet and enter the **haEnable** command to restore high availability; then fail over the active CP blade by entering the **haFailover** command.

Traffic flow through the active CP blade resumes when the failover is complete.

9. Connect the serial cable to the serial port on the new standby CP blade (previously the active CP blade).
10. Repeat [step 2](#) through [step 7](#) for the new standby CP blade (each CP blade has a separate boot PROM password).
11. Connect to the active CP blade by serial or Telnet and enter the **haEnable** command to restore high availability.

Although you can set the boot PROM password without also setting the recovery string, it is strongly recommended that you set both the password and the string as described in [“Setting the boot PROM password for a switch with a recovery string”](#) on page 95. If your site procedures dictate that you must set the boot PROM password without the string, follow the procedure that applies to your switch model.

## Setting the boot PROM password for a switch without a recovery string

This procedure applies to the following switch models: Brocade 300, 4100, 4900, 5000, 5410, 5424, 5450, 5460, 5470, 5480, 5100, 5300, 7500, 7500E, 7600, 7800, 8000, and VA-40FC switches.

The password recovery instructions contained within this section are only for the switches listed. If your switch is not listed, contact your switch support provider for instructions.

1. Create a serial connection to the switch as described in [“Connecting to Fabric OS through the serial port”](#) on page 16.
2. Reboot the switch by entering the **reboot** command.
3. Press **ESC** within four seconds after the message “Press escape within 4 seconds...” displays.

The following options are available:

Option	Description
1	Start system. Continues the system boot process.
2	Recovery password. Lets you set the recovery string and the boot PROM password.
3	Enter command shell. Provides access to boot parameters.

4. Enter **3**.

5. At the shell prompt, enter the **passwd** command.

---

**NOTE**

The **passwd** command only applies to the boot PROM password when it is entered from the boot interface.

---

6. Enter the boot PROM password at the prompt, then re-enter it when prompted. The password must be eight alphanumeric characters (any additional characters are not recorded). Record this password for future use.
7. Enter the **saveEnv** command to save the new password.
8. Reboot the switch by entering the **reset** command.

### Setting the boot PROM password for a director without a recovery string

This procedure applies to the following enterprise-class platforms: Brocade 48000 director, Brocade DCX and DCX-4S Data Center Backbones.

On the Brocade 48000 director and Brocade DCX enterprise-class platforms, set the password on the standby CP blade, fail over, and then set the password on the previously active (now standby) CP blade to minimize disruption to the fabric.

1. Determine the active CP blade by opening a Telnet session to either CP blade, connecting as admin, and entering the **haShow** command.
2. Connect to the active CP blade by serial or Telnet and enter the **haDisable** command to prevent failover during the remaining steps.
3. Create a serial connection to the standby CP blade as described in [“Connecting to Fabric OS through the serial port”](#) on page 16.
4. Reboot the standby CP blade by sliding the On/Off switch on the ejector handle of the standby CP blade to Off, and then back to On.

This causes the blade to reset.

5. Press **ESC** within four seconds after the message `Press escape within 4 seconds...` displays.

The following options are available:

Option	Description
1	Start system. Continues the system boot process.
2	Recovery password. Lets you set the recovery string and the boot PROM password.
3	Enter command shell. Provides access to boot parameters.

6. Enter **3**.
7. Enter the **passwd** command at the shell prompt.

---

**NOTE**

The **passwd** command applies only to the boot PROM password when it is entered from the boot interface.

---

8. Enter the boot PROM password at the prompt, then re-enter it when prompted. The password must be eight alphanumeric characters (any additional characters are not recorded). Record this password for future use.
9. Enter the **saveEnv** command to save the new password.
10. Reboot the standby CP blade by entering the **reset** command.
11. Connect to the active CP blade by serial or Telnet and enter the **haEnable** command to restore high availability; then fail over the active CP blade by entering the **haFailover** command.  
Traffic resumes flowing through the newly active CP blade after it has completed rebooting.
12. Connect the serial cable to the serial port on the new standby CP blade (previously the active CP blade).
13. Repeat [step 3](#) through [step 10](#) for the new standby CP blade.
14. Connect to the active CP blade by serial or Telnet and enter the **haEnable** command to restore high availability.

---

**NOTE**

To recover lost passwords refer to the *Fabric OS Troubleshooting and Diagnostics Guide*.

---

## The authentication model using RADIUS and LDAP

Fabric OS supports the use of either the local user database and the remote authentication dial-in user service (RADIUS) at the same time; or the local user database and lightweight directory access protocol (LDAP) using Microsoft Active Directory in Windows at the same time. A switch can be configured to try both RADIUS or LDAP and local switch authentication.

When configured to use either RADIUS or LDAP, the switch acts as a network access server (NAS) and RADIUS or LDAP client. The switch sends all authentication, authorization, and accounting (AAA) service requests to the RADIUS or LDAP server. The RADIUS or LDAP server receives the request, validates the request, and sends its response back to the switch.

The supported management access channels that integrate with RADIUS or LDAP include serial port, Telnet, SSH, Web Tools, and API. All these require the switch IP address or name to connect. The RADIUS server accepts both IPv4 and IPv6 address formats, while the LDAP server accepts only an IPv4 address. For accessing both the active and standby CP, and for the purpose of HA failover, both CP IP addresses of a director should be included in the RADIUS or LDAP server configuration.

---

**NOTE**

For systems such as the Brocade 48000 and Brocade DCX enterprise-class platforms, the switch IP addresses are aliases of the physical Ethernet interfaces on the CP blades. When specifying client IP addresses for the logical switches in such systems, make sure the CP IP addresses are used.

---

When configured for RADIUS or LDAP, a switch becomes a RADIUS or LDAP client. In either of these configurations, authentication records are stored in the RADIUS or LDAP host server database. Login and logout account name, assigned role, and time-accounting records are also stored on the RADIUS or LDAP server for each user.

By default, the RADIUS and LDAP services are disabled, so AAA services default to the switch's local database.

## 5 The authentication model using RADIUS and LDAP

To enable RADIUS or LDAP service, it is strongly recommended that you access the CLI through an SSH connection so that the shared secret is protected. Multiple login sessions can configure simultaneously, and the last session to apply a change leaves its configuration in effect. After a configuration is applied, it persists after a reboot or an HA failover.

To enable LDAP service, you need to install a certificate on the Microsoft Active Directory server.

The configuration applies to all switches and on a director the configuration replicates itself on a standby CP blade if one is present. It is saved in a configuration upload and applied in a configuration download.

You should configure at least two RADIUS servers so that if one fails, the other will assume service.

You can set the configuration with both RADIUS or LDAP service and local authentication enabled so that if the RADIUS or LDAP servers do not respond due to power failure or network problems, the switch uses local authentication.

Consider the effects of the use of RADIUS or LDAP service on other Fabric OS features. For example, when RADIUS or LDAP service is enabled, all account passwords must be managed on the RADIUS or LDAP server. The Fabric OS mechanisms for changing switch passwords remain functional; however, such changes affect only the involved switches locally. They do not propagate to the RADIUS or LDAP server, nor do they affect any account on the RADIUS or LDAP server.

When RADIUS or LDAP is set up for a fabric that contains a mix of switches with and without RADIUS or LDAP support, the way a switch authenticates users depends on whether a RADIUS or LDAP server is set up for that switch. For a switch with RADIUS or LDAP support and configuration, authentication bypasses the local password database. For a switch without RADIUS or LDAP support or configuration, authentication uses the switch's local account names and passwords.

[Table 15](#) on page 100 outlines the **aaaConfig** command options used to set up the authentication mode.

**TABLE 15 Authentication configuration options**

aaaConfig options	Description	Equivalent setting in Fabric OS v5.1.0 and earlier	
		--radius	--switchdb <sup>1</sup>
--authspec "local"	Default setting. Authenticates management connections against the local database only. If the password does not match or the user is not defined, the login fails.	Off	On
--authspec "radius"	Authenticates management connections against any RADIUS databases only. If the RADIUS service is not available or the credentials do not match, the login fails.	On	Off
--authspec "radius;local"	Authenticates management connections against any RADIUS databases first. If RADIUS fails <i>for any reason</i> , authenticates against the local user database.	not supported	not supported

TABLE 15 Authentication configuration options (Continued)

aaaConfig options	Description	Equivalent setting in Fabric OS v5.1.0 and earlier	
		--radius	--switchdb <sup>1</sup>
--authspec "radius;local" --backup	Authenticates management connections against any RADIUS databases. If RADIUS fails because the service is not available, it then authenticates against the local user database. The --backup option directs the service to try the secondary authentication database only if the primary authentication database is not available.	On	On
--authspec "ldap"	Authenticates management connections against any LDAP databases only. If LDAP service is not available or the credentials do not match, the login fails.	n/a	n/a
--authspec "ldap; local"	Authenticates management connections against any LDAP databases first. If LDAP fails for any reason, it then authenticates against the local user database.	n/a	On
--authspec "ldap; local" --backup	Authenticates management connections against any LDAP databases first. If LDAP fails for any reason, it then authenticates against the local user database. The --backup option states to try the secondary authentication database only if the primary authentication database is not available.	n/a	On

1. Fabric OS v5.1.0 and earlier aaaConfig --switchdb <on | off> setting.

## Setting the switch authentication mode

1. Connect to the switch and log in using an account assigned to the admin role.
2. Enter the `aaaConfig --authspec` command.

## Fabric OS user accounts

RADIUS and LDAP servers allow you to set up user accounts by their true network-wide identity rather than by the account names created on a Fabric OS switch. With each account name, assign the appropriate switch access roles. For LDAP servers, you can use the `ldapCfg --maprole <ldap_role name> <switch_role>` command to map an LDAP server role to one of the default roles available on a switch.

RADIUS and LDAP support all the defined RBAC roles described in [Table 10](#) on page 84.

Users must enter their assigned RADIUS or LDAP account name and password when logging in to a switch that has been configured with RADIUS or LDAP. After the RADIUS or LDAP server authenticates a user, it responds with the assigned switch role in a *Brocade Vendor-Specific Attribute* (VSA). If the response does not have a VSA role assignment, the User role is assigned. If no Administrative Domain is assigned, then the user is assigned to the default Admin Domain ADO.

You can set a user password expiration date and add a warning for RADIUS login. The password expiry date must be specified in UTC and in MM/DD/YYYY format. The password warning specifies the number of days prior to the password expiration that a warning of password expiration notifies the user. You either specify both attributes or none. If you specify a single attribute or there is a syntax error in the attributes, the password expiration warning will not be issued. If your RADIUS server maintains its own password expiration attributes, you must set the exact date twice to use this feature, once on your RADIUS server and once in the VSA attribute. If the dates do not match, then the RADIUS server authentication fails.

The syntax used for assigning VSA-based account switch roles on a RADIUS server is described in [Table 16](#).

**TABLE 16** Syntax for VSA-based account roles

Item	Value	Description
Type	26	1 octet
Length	7 or higher	1 octet, calculated by the server
Vendor ID	1588	4 octet, Brocade SMI Private Enterprise Code
Vendor type	1	1 octet, Brocade-Auth-Role; valid attributes for the Brocade-Auth-Role are: Admin BasicSwitchAdmin FabricAdmin Operator SecurityAdmin SwitchAdmin User ZoneAdmin
	2	<i>Optional:</i> Specifies the Admin Domain or Virtual Fabric member list. For more information on Admin Domains or Virtual Fabrics, see <a href="#">“RADIUS configuration with Admin Domains or Virtual Fabrics”</a> on page 104. Brocade-AVPairs1
	3	Brocade-AVPairs2
	4	Brocade-AVPairs3
	5	Brocade-AVPairs4
	6	Brocade Password ExpiryDate
	7	Brocade Password ExpiryWarning
Vendor length	2 or higher	1 octet, calculated by server, including vendor-type and vendor-length
Attribute-specific data	ASCII string	Multiple octet, maximum 253, indicating the name of the assigned role and other supported attribute values such as Admin Domain member list.

## Fabric OS users on the RADIUS server

All existing Fabric OS mechanisms for managing local switch user accounts and passwords remain functional when the switch is configured to use RADIUS. Changes made to the local switch database do not propagate to the RADIUS server, nor do the changes affect any account on the RADIUS server.

## Windows 2000 IAS

To configure a Windows 2000 internet authentication service (IAS) server to use VSA to pass the Admin role to the switch in the dial-in profile, the configuration specifies the Vendor code (1588), Vendor-assigned attribute number (1), and attribute value (admin), as shown in [Figure 13](#).

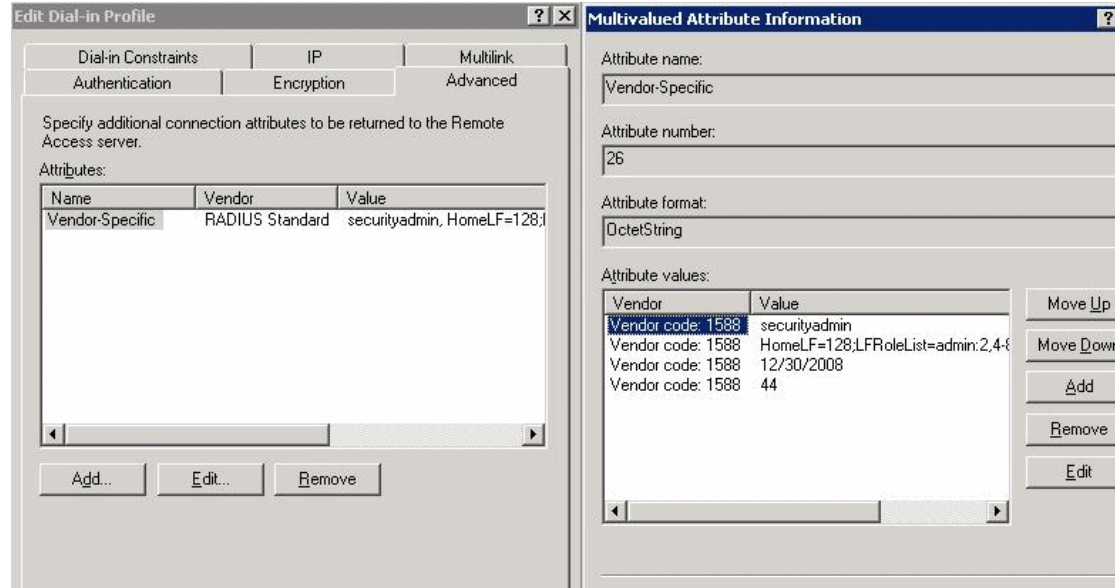

FIGURE 13 Windows 2000 VSA configuration

## Linux FreeRadius server

For the configuration on a Linux FreeRadius server, define the values outlined in [Table 17](#) in a vendor dictionary file called `dictionary.brocade`.

TABLE 17 `dictionary.brocade` file entries

Include	Key	Value
VENDOR	Brocade	1588
ATTRIBUTE	Brocade-Auth-Role	1 string Brocade
	Brocade-AVPairs1, 2, 3, 4	2, 3, 4, 5 string Admin Domain or Virtual Fabric member list
	Brocade-Passwd-ExpiryDate	6 string MM/DD/YYYY in UTC
	Brocade-Passwd-WarnPeriod	7 integer in days

After you have completed the dictionary file, define the role for the user in a configuration file. For example, to grant the user `jsmith` the Admin role, you would add the following statement to the configuration file:

```
swladmin      Auth-Type := Local, User-Password == "myPassword"
              Brocade-Auth-Role = "admin",
              Brocade-AVPairs1 = "HomeLF=70",
              Brocade-AVPairs2 =
              "LFRoleList=admin:2,4-8,70,80,128;ChassisRole=admin",
              Brocade-Passwd-ExpiryDate = "11/10/2008",
              Brocade-Passwd-WarnPeriod = "30"
```

### ***RADIUS configuration with Admin Domains or Virtual Fabrics***

When configuring users with Admin Domains or Virtual Fabrics, you must also include the Admin Domain or Virtual Fabric member list. This section describes the way that you configure attribute types for this configuration.

The values for the new attribute types use the syntax *key=val[;key=val]*, where *key* is a text description of attributes, *value* is the attribute value for the given key, the equal sign (=) is the separator between key and value, and the semi-colon (;) is an optional separator for multiple key-value pairs.

Multiple key-value pairs can appear for one Vendor-Type code. Key-value pairs with the same key name may be concatenated across multiple Vendor-Type codes. You can use any combination of the Vendor-Type codes to specify key-value pairs. Note that a switch always parses these attributes from *Vendor-Type code 2* to *Vendor-Type code 4*.

Only four kinds of keys are accepted; all other keys are ignored. The following keys are accepted:

- *HomeAD* is the designated home Admin Domain for the account. The valid range of values is from 0 to 255. The first valid HomeAD key-value pair is accepted by the switch, and any additional HomeAD key-value pairs are ignored.
- *ADList* is a comma-separated list of Administrative Domain numbers to which this account is a member. Valid numbers range from 0 to 255. A dash between two numbers specifies a range. Multiple ADlist key-value pairs within the same or across the different Vendor-Type codes are concatenated. Multiple occurrences of the same Admin Domain number are ignored.
- *HomeLF* is the designated home Virtual Fabric for the account. The valid values are between 1 to 128 and chassis context. The first valid HomeLF key-value pair is accepted by the switch, additional HomeLF key-value pairs are ignored.
- *LFRoleList* is a comma-separated list of Virtual Fabric ID numbers to which this account is a member. Valid numbers range from 1 to 128. A dash between two numbers specifies a range. Multiple Virtual Fabric list key-value pairs within the same or across the different Vendor-Type codes are concatenated. Multiple occurrences of the same Virtual Fabric ID number are ignored.

RADIUS authentication requires that the account have a valid role through the attribute type Brocade-Auth-Role. The additional attribute values ADList, HomeAD, HomeLF, and LFRoleList are optional. If they are unspecified, the account can log in with ADO as its member list and home Admin Domain or VF128 as its member list and home Virtual Fabric. If there is an error in the ADlist, HomeAD, LFRoleList, or HomeLF specification, the account cannot log in until the AD list or Virtual Fabric list is corrected; an error message is displayed.

For example, on a Linux FreeRadius Server, the user (user-za) with the following settings takes the “zoneAdmin” role, with AD member list: 1, 2, 4, 5, 6, 7, 8, 9, 12; the Home Admin Domain will be 1.

```
user-za Auth-Type := Local, User-Password == "password"
Brocade-Auth-Role = "ZoneAdmin",
Brocade-AVPairs1 = "ADList=1,2,6,"
Brocade-AVPairs2 = "ADList=4-8;ADList=7,9,12"
```

In the next example, on a Linux FreeRadius Server, the user takes the “operator” role, with ADList 1, 2, 4, 5, 6, 7, 8, 9, 12, 20 and HomeAD 2.

```
user-opr Auth-Type := Local, User-Password == "password"
Brocade-Auth-Role = "operator",
Brocade-AVPairs1 = "ADList=1,2;HomeAD=2",
Brocade-AVPairs2 = "ADList=-4-8,20;ADList=7,9,12"
```



In the next example, on a Linux FreeRadius Server, the user takes the “zoneAdmin” role, with VList 2, 4, 5, 6, 7, 8, 10, 11, 12, 13, 15 17, 19, 22, 23, 24, 25, 29, 31 and HomeLF 1.

```
user300 Auth-Type := Local, User-Password == "password"
Brocade-Auth-Role = "zoneadmin",
Brocade-AVPairs1 = "HomeLF=1;LFRoleList=securityadmin:2,4-8,10"
Brocade-AVPairs2 = "LFRoleList=admin:11-13, 15, 17, 19;user:22-25,29,31"
```

## The RADIUS server

---

### NOTE

To set up the RADIUS server, you must know the switch IP address, in either IPv4 or IPv6 notation, or the name to connect to switches. Use the **ipAddrShow** command to display a switch IP address.

---

For Brocade directors, the switch IP addresses are aliases of the physical Ethernet interfaces on the CP blades. When specifying client IP addresses for the logical switches in these systems, make sure the CP blade IP addresses are used. For accessing both the active and standby CP blade, and for the purpose of HA failover, both of the CP blade IP addresses must be included in the RADIUS server configuration.

User accounts should be set up by their true network-wide identity, rather than by the account names created on a Fabric OS switch. Along with each account name, the administrator must assign appropriate switch access roles. To manage a fabric, these roles can be User, Admin, and SecurityAdmin.

### *Configuring RADIUS server support with Linux*

The following procedures work for FreeRADIUS on Solaris and Red Hat Linux. FreeRADIUS is a freeware RADIUS server that you can find at the following web site:

[www.freeradius.org](http://www.freeradius.org)

Follow the installation instructions at the web site. FreeRADIUS runs on Linux (all versions), FreeBSD, NetBSD, and Solaris. If you make a change to any of the files used in this configuration, you must stop the server and restart it for the changes to take effect.

FreeRADIUS installation places the configuration files in `$PREFIX/etc/raddb`. By default, the PREFIX is `/usr/local`.

Configuring RADIUS service on Linux consists of the following tasks:

- Adding the Brocade attribute to the server
- Creating the user
- Enabling clients

#### **Adding the Brocade attribute to the server**

1. Create and save the file `$PREFIX/etc/raddb/dictionary.brocade` with the following information:

```
#
# dictionary.brocade
#
VENDOR Brocade 1588

#
# attributes
#
```

## 5 The authentication model using RADIUS and LDAP

ATTRIBUTE	Brocade-Auth-Role	1	string	Brocade
ATTRIBUTE	Brocade-AVPairs1	2	string	Brocade
ATTRIBUTE	Brocade-AVPairs2	3	string	Brocade
ATTRIBUTE	Brocade-AVPairs3	4	string	Brocade
ATTRIBUTE	Brocade-AVPairs4	5	string	Brocade
ATTRIBUTE	Brocade-Passwd-ExpiryDate	6	string	Brocade
ATTRIBUTE	Brocade-Passwd-WarnPeriod	7	string	Brocade

This defines the Brocade vendor ID as 1588, the Brocade attribute 1 as Brocade-Auth-Role and 6 as Brocade-Passwd-ExpiryDate, both are string values. The Brocade attribute 7 as Brocade-Passwd-WarnPeriod, and it is an integer value.

2. Open the file `$PREFIX/etc/raddb/dictionary` in a text editor and add the line:

```
$INCLUDE dictionary.brocade
```

As a result, the file `dictionary.brocade` is located in the RADIUS configuration directory and loaded for use by the RADIUS server.

### Creating the user

1. Open the `$PREFIX/etc/raddb/user` file in a text editor.
2. Add the user names and their roles for users accessing the switch and authenticating through RADIUS.

The user will log in using the role specified with Brocade-Auth-Role. The valid roles include Root, Admin, SwitchAdmin, ZoneAdmin, SecurityAdmin, BasicSwitchAdmin, FabricAdmin, Operator and User. You must use quotation marks around "password" and "role".

### Example of adding a user name to the RADIUS authentication

For example, to set up an account called JohnDoe with the Admin role with a password expiry date of May 28, 2008 and a warning period of 30 days:

```
JohnDoe Auth-Type := Local
User-Password == "johnPassword",
Brocade-Auth-Role = "admin",
Brocade-Auth-Role = "admin",
Brocade-Passwd-ExpiryDate = "05/28/08",
Brocade-Passwd-WarnPeriod = 30
```

### Example of using the local system password to authenticate users

The next example uses the local system password file to authenticate users.

```
swadmin Auth-Type := System
Brocade-Auth-Role = "admin",
Brocade-AVPairs1 = "HomeLF=70",
Brocade-AVPairs2 = "LFRoleList=admin:2,4-8,70,80,128",
Brocade-AVPairs3 = "ChassisRole=switchadmin",
Brocade-Passwd-ExpiryDate = "11/10/2008",
Brocade-Passwd-WarnPeriod = "30"
```

When you use network information service (NIS) for authentication, the only way to enable authentication with the password file is to force the Brocade switch to authenticate using password authentication protocol (PAP); this requires the `-a pap` option with the `aaaConfig` command.

**Enabling clients**

Clients are the switches that will use the RADIUS server; each client must be defined. By default, all IP addresses are blocked.

The Brocade 48000 director, Brocade DCX and DCX-4S enterprise-class platforms send their RADIUS requests using the IP address of the active CP. When adding clients, add both the active and standby CP IP addresses so that, in the event of a failover, users can still log in to the switch.

1. Open the `$PREFIX/etc/raddb/client.config` file in a text editor and add the switches that are to be configured as RADIUS clients.

For example, to configure the switch at IP address 10.32.170.59 as a client:

```
client 10.32.170.59
    secret      = Secret
    shortname   = Testing Switch
    nastype     = other
```

In this example, *shortname* is an alias used to easily identify the client. *Secret* is the shared secret between the client and server. Make sure the shared secret matches that configured on the switch (see [“Adding a RADIUS or LDAP server to the switch configuration”](#) on page 114).

2. Save the file `$PREFIX/etc/raddb/client.config` then start the RADIUS server as follows:

```
$PREFIX/sbin/radiusd
```

***Configuring RADIUS server support with Windows 2000***

The instructions for setting up RADIUS on a Windows 2000 server are listed here for your convenience but are not guaranteed to be accurate for your network environment. Always check with your system administrator before proceeding with setup.

**NOTE**

All instructions involving Microsoft Windows 2000 can be obtained from [www.microsoft.com](http://www.microsoft.com) or your Microsoft documentation. Confer with your system or network administrator prior to configuration for any special needs your network environment may have.

Configuring RADIUS service on Windows 2000 consists of the following steps:

1. Installing internet authentication service (IAS)

For more information and instructions on installing IAS, refer to the Microsoft Web site.

2. Enabling the Challenge Handshake Authentication Protocol (CHAP)

If CHAP authentication is required, then Windows must be configured to store passwords with reversible encryption. Reverse password encryption is not the default behavior; it must be enabled.

**NOTE**

If a user is configured prior to enabling reverse password encryption, then the user's password is stored and cannot utilize CHAP. To use CHAP, the password must be re-entered after encryption is enabled. If the password is not re-entered, then CHAP authentication will not work and the user will be unable to authenticate from the switch.

3. Configuring a user

## 5 The authentication model using RADIUS and LDAP

IAS is the Microsoft implementation of a RADIUS server and proxy. IAS uses the Windows native user database to verify user login credentials; it does not list specific users, but instead lists *user groups*. Each user group should be associated with a specific switch login role. For example, you should configure a user group for root, admin, factory, switchAdmin, and user, and then add any users whose logins you want to associate to the appropriate group.

### 4. Configuring the server

For more information and instructions on configuring the server, refer to the Microsoft Web site. Below is the information you will need to configure the RADIUS server for a Brocade switch. A client is the device that uses the RADIUS server; in this case, it is the switch.

- a. For the Add RADIUS Client window, provide the following:

Client address (IP or DNS)—Enter the IP address of the switch.

Client-Vendor—Select **RADIUS Standard**.

Shared secret—Provide a password. Shared secret is a password used between the client device and server to prevent IP address spoofing by unwanted clients. Keep your shared secret password in a safe place. You will need to enter this password in the switch configuration.

After clicking Finish, add a new client for all switches on which RADIUS authentication will be used.

- b. In the Internet Authentication Service window, right-click the Remote Access Policies folder; then select **New Remote Access Policy** from the pop-up window.

A remote access policy must be created for each Brocade login role (Root, Admin, Factory, SwitchAdmin, and User) for which you want to use RADIUS. Apply this policy to the user groups that you already created.

- c. In the Vendor-Specific Attribute Information window, enter the vendor code value **1588**. Click the **Yes. It conforms** radio button and then click **Configure Attribute**.

- d. In the Configure VSA (RFC compliant) window, enter the following values and click **OK**.

Vendor-assigned attribute number—Enter the value **1**.

Attribute format—Enter **String**.

Attribute value—Enter the login role (Root, Admin, SwitchAdmin, User, etc.) the user group must use to log in to the switch.

- e. After returning to the Internet Authentication Service window, add additional policies for all Brocade login types for which you want to use the RADIUS server. After this is done, you can configure the switch.

### ***RSA RADIUS server***

Traditional password-based authentication methods are based on *one-factor* authentication, where you confirm your identity using a memorized password. Two-factor authentication increases the security by using a second factor to corroborate identification. The first factor is either a PIN or password and the second factor is the RSA SecurID token.

RSA SecurID with an RSA RADIUS server is used for user authentication. The Brocade switch does not communicate directly with the RSA Authentication Manager, so the RSA RADIUS server is used in conjunction with the switch to facilitate communication.

To learn more about how RSA SecurID works, visit [www.rsa.com](http://www.rsa.com) for more information.

### Setting up the RSA RADIUS server

For more information on how to install and configure the RSA Authentication Manager and the RSA RADIUS server, refer to your documentation or visit [www.rsa.com](http://www.rsa.com).

1. Create user records in the RSA Authentication Manager.
2. Configure the RSA Authentication Manager by adding an agent host.
3. Configure the RSA RADIUS server.

Setting up the RSA RADIUS server involves adding RADIUS clients, users, and vendor specific attributes to the RSA RADIUS server.

- a. Add the following data to the `vendor.ini` file:

```
vendor-product = Brocade
dictionary = brocade
ignore-ports = no
port-number-usage = per-port-type
help-id = 2000
```

- b. Create a `brocade.dct` file that needs to be added into the `dictionary.dcm` file located in the following path:

```
C:\Program Files\RSA Security\RSA RADIUS\Service
```

[Figure 14](#) on page 110 shows what the `brocade.dct` file should look like and [Figure 15](#) on page 110 shows what needs to be modified in the `brocade.dcm` file.

---

#### NOTE

The dictionary files for RSA RADIUS Server must remain in the installation directory. Do not move the files to other locations on your computer.

---

Add *Brocade-VSA macro* and define the attributes as follows:

- vid (Vendor-ID): 1588
- type1 (Vendor-Type): 1
- len1 (Vendor-Length): >=2

## 5 The authentication model using RADIUS and LDAP

```
#####
# brocade.dct -- Brocade Dictionary
#
# (See readme.dct for more details on the format of this file)
#####
#
# Use the Radius specification attributes in lieu of the Brocade one:
#
@radius.dct

MACRO Brocade-VSA(t,s) 26 [vid=1588 type1=%t% len1=+2 data=%s%]

ATTRIBUTE Brocade-Auth-Role Brocade-VSA(1,string) r
ATTRIBUTE Brocade-Passwd-ExpiryDate Brocade-VSA(6,string) r
ATTRIBUTE Brocade-Passwd-WarnPeriod Brocade-VSA(7,integer) r

#####
# brocade.dct -- Brocade Dictionary
#####
```

FIGURE 14 Example of a Brocade DCT file

```
#####
# dictiona.dcm
#####

# Generic Radius

@radius.dct

#
# Specific Implementations (vendor specific)
#
@3comsw.dct
@aat.dct
@acc.dct
@accessbd.dct
@agere.dct
@agns.dct
@airespace.dct
@alcatel.dct
@altiga.dct
@annex.dct
@aptis.dct
@ascend.dct
@ascndvsa.dct
@axc.dct
@brocade.dct
@bandwagn.dct
@brocade.dct <-----
```

FIGURE 15 Example of the *dictiona.dcm* file

- c. When selecting items from the **Add Return List Attribute**, select *Brocade-Auth-Role* and type the string *Admin*. The string will equal the role on the switch.

- d. Add the Brocade profile.
- e. In **RSA Authentication Manager**, edit the user records that will be authenticating using RSA SecurID.

## LDAP configuration and Microsoft Active Directory

LDAP provides user authentication and authorization using the Microsoft Active Directory service in conjunction with LDAP on the switch. There are two modes of operation in LDAP authentication, FIPS mode and non-FIPS mode. This section discusses LDAP authentication in non-FIPS mode. For more information on LDAP in FIPS mode, refer to [Chapter 7, “Configuring Security Policies”](#). The following are restrictions when using LDAP in non-FIPS mode:

- There is no password change through Active Directory.
- There is no automatic migration of newly created users from the local switch database to Active Directory. This is a manual process explained later.
- Only IPv4 is supported for LDAP.
- LDAP authentication is used on the local switch only and not for the entire fabric.
- You can use the User-Principal-Name and not the Common-Name for AD LDAP authentication. To provide backward compatibility, authentication based on the Common Name is still supported for Active Directory LDAP 2000 and 2003. Common Name based-authentication is not recommended for new installations.
- A user can belong to multiple groups as long as one of the groups has the same name as the Brocade role name. Among those groups, one group name must match with either the Brocade role or be mapped to a switch role in the Brocade switch.
- A user can be part of any Organizational Unit (OU).
- Active Directory LDAP 2000, 2003, and 2003 is supported.

Roles for Brocade-specific users can be added through the Microsoft Management Console. Groups created in Active Directory must correspond directly to the RBAC user roles on the switch. Role assignments can be achieved by including the user in the respective group. A user can be assigned to multiple groups like Switch Admin and Security Admin. For LDAP servers, you can use the `ldapCfg --maprole ldap_role name switch_role` command to map an LDAP server role to one of the default roles available on a switch. For more information on RBAC roles, see [“Role-Based Access Control \(RBAC\)”](#) on page 84.

---

### NOTE

All instructions involving Microsoft Active Directory can be obtained from [www.microsoft.com](http://www.microsoft.com) or your Microsoft documentation. Confer with your system or network administrator prior to configuration for any special needs your network environment may have.

---

Following is the overview of the process used to set up LDAP:

1. Install a Certificate Authority (CA) certificate on the Windows Active Directory server for LDAP. Follow Microsoft instructions for generating and installing CA certificates on a Windows server.
2. Create a user in Microsoft Active Directory server. For instructions on how to create a user, refer to [www.microsoft.com](http://www.microsoft.com) or Microsoft documentation to create a user in your Active Directory.

## 5 The authentication model using RADIUS and LDAP

3. Create a group name that uses the switch's role name so that the Active Directory group's name is the same as the switch's role name.

or

Use the `ldapCfg --maprole ldap_role_name switch_role` command to map an LDAP server role to one of the default roles available on the switch.

4. Associate the user to the group by adding the user to the group.

For instructions on how to create a user refer to [www.microsoft.com](http://www.microsoft.com) or Microsoft documentation to create a user in your Active Directory.

5. Add the user's Administrative Domains or Virtual Fabrics to the CN\_list by editing the `adminDescription` value.

This will map the Admin Domains or Virtual Fabrics to the user name. Multiple Admin Domains can be added as a string value separated by the underscore character ( `_` ). Virtual Fabrics are added as a string value separate by a colon ( `,` ) and entered as a range.

6. Add the attribute `brcdAdVfData` to the existing Active Directory schema.

### *Creating a user*

To create a user in Active Directory, refer to [www.microsoft.com](http://www.microsoft.com) or Microsoft documentation. There are no special attributes to set. You can use a fully qualified name for logging in, for example you can log in as "user@domain.com".

### *Creating a group*

To create a group in Active Directory, refer to [www.microsoft.com](http://www.microsoft.com) or Microsoft documentation. You will need to verify that the group has the following attributes:

- The name of the group has to match the RBAC role.
- The Group Type must be *Security*.
- The Group Scope must be *Global*.
- Any user you create must have domain users as their primary group.
- If the user you created is not a member of the Users OU then the User Principal Name, in the format of "user@domain", is required to login.

### *Assigning the group (role) to the user*

To assign the user to a group in Active Directory, refer to [www.microsoft.com](http://www.microsoft.com) or Microsoft documentation. You will need to verify that the user has the following attributes:

- Update the `memberOf` field with the login role (Root, Admin, SwitchAdmin, User, etc.) that the user must use to log in to the switch.

or

If you have a user-defined group, then use the `ldapCfg --maprole ldap_role_name switch_role` command to map an LDAP server role to one of the default roles available on a switch.



### *Adding an Admin Domain or Virtual Fabric list*

1. From the Windows Start menu, select **Programs> Administrative Tools> ADSI.msc**  
 ADSI is a Microsoft Windows Resource Utility. This will need to be installed to proceed with the rest of the setup. For Windows 2003, this utility comes with Service Pack 1 or you can download this utility from the Microsoft web site.
2. Go to **CN=Users**
3. Right click on select **Properties**. Click the **Attribute Editor** tab.
4. Double-click the **adminDescription** attribute.  
 This opens the String Attribute Editor dialog box.
5. Perform the appropriate action based on whether you are using Administrative Domains or Virtual Fabrics:
  - If you are using Administrative Domains, enter the value of the Admin Domain separated by an underscore ( **\_** ) into the **Value** field.  
**Example for adding Admin Domains**  
`adlist_0_10_200_endAd`  
 Home Admin Domain (homeAD) for the user will be the first value in the *adlist* (Admin Domain list). If a user has no values assigned in the *adlist* attribute, then the homeAD '0' will be the default administrative domain for the user.
  - If you are using Virtual Fabrics, enter the value of the logical fabric separated by a semi-colon ( **;** ) into the **Value** field.  
**Example for adding Virtual Fabrics**  
`HomeLF=10;LFRoleList=admin:128,10;ChassisRole=admin`  
 In this example, the logical switch that would be logged into by default is 10. If 10 is not available then the lowest FID available will be chosen. You would have permission to enter logical switch 128 and 10 in an admin role and you would also have the chassis role permission of admin.

---

#### **NOTE**

You can perform batch operations using the *Ldifde.exe* utility. For more information on importing and exporting schemas, refer to your Microsoft documentation or visit [www.microsoft.com](http://www.microsoft.com).

---

### *Adding attributes to the Active Directory Schema*

To create a group in Active Directory, refer to [www.microsoft.com](http://www.microsoft.com) or Microsoft documentation. You will need to verify that the schema has the following attributes:

- Add a new attribute **brcdAdvfData** as Unicode String.
- Add **brcdAdvfData** to the person's properties.

## Authentication servers on the switch

At least one RADIUS or LDAP server must be configured before you can enable RADIUS or LDAP service. You can configure the RADIUS or LDAP service even if it is disabled on the switch. You can configure up to five RADIUS or LDAP servers. You must be logged in as admin or switchAdmin to configure the RADIUS service.

---

### NOTE

On dual-CP enterprise-class platforms (Brocade 48000, Brocade DCX and DCX-4S backbones), the switch sends its RADIUS or LDAP request using the IP address of the active CP. When adding clients, add both the active and standby CP IP addresses so that users can still log in to the switch in the event of a failover.

---

RADIUS or LDAP configuration is chassis-based configuration data. On platforms containing multiple switch instances, the configuration applies to all instances. The configuration is persistent across reboots and firmware downloads. On a chassis-based system, the command must replicate the configuration to the standby CP.

Multiple login sessions can invoke the command simultaneously. The last session that applies the change is the one whose configuration is in effect. This configuration is persistent after an HA failover.

The RADIUS or LDAP servers are contacted in the order they are listed, starting from the top of the list and moving to the bottom.

### *Adding a RADIUS or LDAP server to the switch configuration*

1. Connect to the switch and log in using an account assigned to the admin role.
2. Enter the `aaaConfig --add` command.

At least one RADIUS or LDAP server must be configured before you can enable the RADIUS or LDAP service.

If no RADIUS or LDAP configuration exists, turning on the RADIUS authentication mode triggers an error message. When the command succeeds, the event log indicates that the configuration is enabled or disabled.

### *Enabling and disabling a RADIUS or LDAP server*

1. Connect to the switch and log in using an account assigned to the admin role.
2. Enter the `aaaConfig --authspec` command to enable RADIUS or LDAP using the local database.

You must specify the type of server as either RADIUS or LDAP, but not both. Local is used for local authentication if the user authentication fails on the RADIUS or LDAP server.

#### Example of enabling RADIUS

```
switch:admin> aaaconfig --authspec "radius;local" --backup
```

### *Deleting a RADIUS or LDAP server from the configuration*

1. Connect to the switch and log in using an account assigned to the admin role.
2. Enter the `aaaConfig --remove` command.

When the command succeeds, the event log indicates that the server is removed.

### *Changing a RADIUS or LDAP server configuration*

1. Connect to the switch and log in using an account assigned to the admin role.
2. Enter the `aaaConfig --change` command.

### *Changing the order in which RADIUS or LDAP servers are contacted for service*

1. Connect to the switch and log in using an account assigned to the admin role.
2. Enter the `aaaConfig --move` command.

When the command succeeds, the event log indicates that a server configuration is changed.

### *Displaying the current RADIUS configuration*

1. Connect to the switch and log in using an account assigned to the admin role.
2. Enter the `aaaConfig --show` command.

If a configuration exists, its parameters are displayed. If RADIUS or LDAP service is not configured, only the parameter heading line is displayed. Parameters include:

Position	The order in which servers are contacted to provide service.
Server	The server names or IPv4 or IPv6 addresses. IPv6 is not supported when using PEAP authentication.
Port	The server ports.
Secret	The shared secrets.
Timeouts	The length of time servers have to respond before the next server is contacted.
Authentication	The type of authentication being used on servers.

## Configuring local authentication as backup

It is useful to enable local authentication so that the switch can take over authentication locally if the RADIUS or LDAP servers fail to respond because of power outage or network problems.

**Example of enabling local authentication, enter the following command for RADIUS**

```
switch:admin> aaaconfig --authspec "radius;local" --backup
```

**Example for LDAP**

```
switch:admin> aaaconfig --authspec "ldap;local" --backup
```

For details about this command see [Table 15](#) on page 100.

When local authentication is enabled and the RADIUS or LDAP servers fail to respond, you can log in to the default switch accounts (admin and user) or any user-defined account. You must know the passwords of these accounts.

When the command succeeds, the event log indicates that local database authentication is disabled or enabled.

## 5 The authentication model using RADIUS and LDAP

# Configuring Protocols

---

## In this chapter

- Security protocols ..... 117
- Secure Copy ..... 118
- Secure Shell protocol ..... 119
- Secure Sockets Layer protocol ..... 122
- Simple Network Management Protocol ..... 127
- Telnet protocol ..... 129
- Listener applications ..... 131
- Ports and applications used by switches ..... 131

## Security protocols

Security protocols provide endpoint authentication and communications privacy using cryptography. Typically, you are authenticated to the switch while the switch remains unauthenticated to you. This means that you can be sure with what you are communicating. The next level of security, in which both ends of the conversation are sure with whom they are communicating, is known as two-factor authentication. Two-factor authentication requires public key infrastructure (PKI) deployment to clients.

Fabric OS supports the secure protocols shown in [Table 18](#).

**TABLE 18** Secure protocol support

Protocol	Description
HTTPS	HTTPS is a Uniform Resource Identifier scheme used to indicate a secure HTTP connection. Web Tools supports the use of hypertext transfer protocol over secure socket layer (HTTPS).
IPsec	Internet Protocol Security (IPsec) is a framework of open standards for providing confidentiality, authentication and integrity for IP data transmitted over untrusted links or networks.
LDAPS	Lightweight Directory Access Protocol over SSL uses a certificate authority (CA). By default, LDAP traffic is transmitted unsecured. You can make LDAP traffic confidential and secure by using Secure Sockets Layer (SSL) / Transport Layer Security (TLS) technology in conjunction with LDAP.
SCP	Secure Copy (SCP) is a means of securely transferring computer files between a local and a remote host or between two remote hosts, using the Secure Shell (SSH) protocol. Configuration upload and download support the use of SCP.
SNMP	SNMP is used in network management systems to monitor network-attached devices for conditions that warrant administrative attention. Supports SNMPv1, v2, and v3.

**TABLE 18** Secure protocol support

Protocol	Description
SSH	Secure Shell (SSH) is a network protocol that allows data to be exchanged over a secure channel between two computers. Encryption provides confidentiality and integrity of data. SSH uses public-key cryptography to authenticate the remote computer and allow the remote computer to authenticate the user, if necessary.
SSL	Fabric OS uses secure socket layer (SSL) to support HTTPS. A certificate must be generated and installed on each switch to enable SSL. Supports SSLv3, 128-bit encryption by default.

[Table 19](#) describes additional software or certificates that you must obtain to deploy secure protocols.

**TABLE 19** Items needed to deploy secure protocols

Protocol	Host side	Switch side
SSHv2	Secure shell client	None
HTTPS	No requirement on host side except a browser that supports HTTPS	Switch IP certificate for SSL
SCP	SSH daemon, SCP server	None
SNMPv1, SNMPv2, SNMPv3	None	None

The security protocols are designed with the four main use cases described in [Table 20](#).

**TABLE 20** Main security scenarios

Fabric	Management interfaces	Comments
Nonsecure	Nonsecure	No special setup is needed to use Telnet or HTTP.
Nonsecure	Secure	Secure protocols may be used. An SSL switch certificate must be installed if HTTPS is used.
Secure	Secure	Switches running earlier Fabric OS versions can be part of the secure fabric, but they do not support secure management. Secure management protocols must be configured for each participating switch. Nonsecure protocols may be disabled on nonparticipating switches. If SSL is used, then certificates must be installed. For more information on installing certificates, refer to <a href="#">"Installing a switch certificate"</a> on page 125.
Secure	Nonsecure	You must use SSH because Telnet is not allowed with some features.

## Secure Copy

The secure copy protocol (SCP) runs on port 22. It encrypts data during transfer, thereby avoiding packet sniffers that attempt to extract useful information during data transfer. SCP relies on SSH to provide authentication and security.

## Setting up SCP for configUploads and downloads

1. Log in to the switch as admin.
2. Type the **configure** command.
3. Type **y** or **yes** at the *cfgload attributes* prompt.
4. Type **y** or **yes** at the *Enforce secure configUpload/Download* prompt.

### Example of setting up SCP for configUpload/download

```
switch:admin> configure
```

Not all options will be available on an enabled switch.  
To disable the switch, use the "switchDisable" command.

Configure...

```
System services (yes, y, no, n): [no] n
ssl attributes (yes, y, no, n): [no] n
http attributes (yes, y, no, n): [no] n
snmp attributes (yes, y, no, n): [no] n
rpcd attributes (yes, y, no, n): [no] n
cfgload attributes (yes, y, no, n): [no] y
```

```
Enforce secure config Upload/Download (yes, y, no, n): [no] y
Enforce signature validation for firmware (yes, y, no, n): [no]
```

## Secure Shell protocol

To ensure security, Fabric OS supports secure shell (SSH) encrypted sessions. SSH encrypts all messages, including the client transmission of the password during login. The SSH package contains a daemon (sshd), which runs on the switch. The daemon supports a wide variety of encryption algorithms, such as Blowfish-Cipher block chaining (CBC) and Advanced Encryption Standard (AES).

---

### NOTE

To maintain a secure network, you should avoid using Telnet or any other unprotected application when you are working on the switch.

The File Transfer Protocol (FTP) is also not secure. When you use FTP to copy files to or from the switch, the contents are in clear text. This includes the remote FTP server's login and password. Some example commands of this limitation are: **supportSave -k**, **configUpload**, **configDownload**, and **firmwareDownload**.

---

Commands that require a secure login channel must originate from an SSH session. If you start an SSH session, and then use the **login** command to start a nested SSH session, commands that require a secure channel will be rejected.

Fabric OS v6.1.0 and later support OpenSSH protocol v2.0 (ssh2). For more information on SSH, refer to the SSH IETF Web site:

<http://www.ietf.org/ids.by.wg/secsh.html>

For more information, refer to *SSH, The Secure Shell: The Definitive Guide* by Daniel J. Barrett, Ph. D., Richard E. Silverman, and Robert G. Byrnes.

## SSH public key authentication

OpenSSH public key authentication provides password-less logins, known as SSH authentication, that uses public and private key pairs for incoming and outgoing authentication. This feature allows only one *allowed-user* to be configured to utilize OpenSSH public key authentication. Using OpenSSH RSA and DSA, the authentication protocols are based on a pair of specially generated cryptographic keys, called the private key and the public key. The advantage of using these key-based authentication systems is that in many cases, it is possible to establish secure connections without having to manually type in a password. RSA and DSA asynchronous algorithms are FIPS-compliant.

### *Allowed-user*

The default admin user must set up the *allowed-user* with the admin role. By default, the admin is the configured *allowed-user*. While creating the key pair, the configured *allowed-user* can choose a passphrase with which the private key is encrypted. Then the passphrase must always be entered when authenticating to the switch. The *allowed-user* must have an admin role that can perform OpenSSH public key authentication, import and export keys, generate a key pair for an outgoing connection, and delete public and private keys. After the *allowed-user* is changed, all the public keys related to the old *allowed-user* are lost.

### *Configuring SSH authentication*

Incoming authentication is used when the remote host needs to authenticate to the switch. Outgoing authentication is used when the switch needs to authenticate to a server or remote host, more commonly used for the **configUpload** command. Both password and public key authentication can coexist on the switch.

After the *allowed-user* is configured, the remaining setup steps must be completed by the *allowed-user*.

1. Log in to the switch as the default admin.
2. Change the *allowed-user*'s role to admin, if applicable.

```
switch:admin> userconfig --change username -r admin
```

Where *username* is the name of the user you want to perform SSH public key authentication, import, export, and delete keys.

3. Set up the *allowed-user* by typing the following command:

```
switch:admin> sshutil allowuser username
```

Where *username* is the name of the user you want to perform SSH public key authentication, import, export, and delete keys.

4. Generate a key pair for host-to-switch (incoming) authentication by logging in to your host as admin, verifying that SSH v2 is installed and working (refer to your host's documentation as necessary) by typing the following command:

```
ssh-keygen -t dsa
```

If you need to generate a key pair for outgoing authentication, skip steps 4 and 5 and proceed to step 6.



**Example of RSA/DSA key pair generation**

```

alloweduser@mymachine: ssh-keygen -t dsa
Generating public/private dsa key pair.
Enter file in which to save the key (/users/alloweduser/.ssh/id_dsa):
Enter passphrase (empty for no passphrase):
Enter same passphrase again:
Your identification has been saved in /users/alloweduser/.ssh/id_dsa.
Your public key has been saved in /users/alloweduser/.ssh/id_dsa.pub.
The key fingerprint is:
32:9f:ae:b6:7f:7e:56:e4:b5:7a:21:f0:95:42:5c:d1 alloweduser@mymachine

```

5. Import the public key to the switch by logging in to the switch as the allowed-user and entering the **sshUtil importpubkey** command to import the key.

**Example of adding the public key to the switch**

```

switch:alloweduser> sshutil importpubkey
Enter IP address:192.168.38.244
Enter remote directory:~auser/.ssh
Enter public key name(must have .pub suffix):id_dsa.pub
Enter login name:auser
Password:
Public key is imported successfully.

```

6. Generate a key pair for switch-to-host (outgoing) authentication by logging in to the switch as the allowed user and entering the **sshUtil genkey** command.

You may enter a passphrase for additional security.

**Example of generating a key pair on the switch**

```

switch:alloweduser> sshutil genkey
Enter passphrase (empty for no passphrase):
Enter same passphrase again:
Key pair generated successfully.

```

7. Export the public key to the host by logging in to the switch as the allowed-user and entering the **sshUtil exportpubkey** command to export the key.

**Example of exporting a public key from the switch**

```

switch:kghanta> sshutil exportpubkey
Enter IP address:192.168.38.244
Enter remote directory:~auser/.ssh
Enter login name:auser
Password:
public key out_going.pub is exported successfully.

```

8. Append the public key to a remote host by logging in to the remote host, locating the directory where authorized keys are stored, and appending the public key to the file.

You may need to refer to the host's documentation to locate where the authorized keys are stored.

9. Test the setup by using a command that uses SCP and authentication, such as **firmwareDownload** or **configUpload**.

### *Deleting keys on the switch*

1. Log in to the switch as the allowed-user.
2. Use the `sshUtil delprivkey` command to delete the private key.

or

Use the `sshUtil delpubkeys` command to delete all public keys.

For more information on IP Filter policies, refer to [Chapter 7, “Configuring Security Policies”](#).

## Secure Sockets Layer protocol

Secure sockets layer (SSL) protocol provides secure access to a fabric through Web-based management tools like Web Tools. SSL support is a standard Fabric OS feature.

Switches configured for SSL grant access to management tools through hypertext transfer protocol over SSL links (which begin with `https://`) instead of standard links (which begin with `http://`).

SSL uses public key infrastructure (PKI) encryption to protect data transferred over SSL connections. PKI is based on digital certificates obtained from an Internet Certificate Authority (CA) that acts as the trusted key agent.

Certificates are based on the switch IP address or fully qualified domain name (FQDN), depending on the issuing CA. If you change a switch IP address or FQDN after activating an associated certificate, you may have to obtain and install a new certificate. Check with the CA to verify this possibility, and plan these types of changes accordingly.

### Browser and Java support

Fabric OS supports the following Web browsers for SSL connections:

- Internet Explorer v7.0 (Microsoft Windows)
- Mozilla Firefox v2.0 (Solaris and Red Hat Linux)

---

#### NOTE

Review the release notes for the latest information and to verify if your platform and browser are supported.

---

In countries that allow the use of 128-bit encryption, you should use the latest version of your browser. For example, Internet Explorer 7.0 and later supports 128-bit encryption by default. You can display the encryption support (called “cipher strength”) using the Internet Explorer **Help:About** menu option. If you are running an earlier version of Internet Explorer, you may be able to download an encryption patch from the Microsoft Web site at <http://www.microsoft.com>.

You should upgrade to the Java 1.6.0 Plug-in on your management workstation. To find the Java version that is currently running, open the Java console and look at the first line of the window.

For more details on levels of browser and Java support, see the *Web Tools Administrator’s Guide*.

## SSL configuration overview

You configure for SSL by obtaining, installing, and activating digital certificates for SSL support. Certificates are required on all switches that are to be accessed through SSL.

Also, you must install a certificate in the Java Plug-in on the management workstation, and you may need to add a certificate to your Web browser.

Configuring for SSL involves these main steps, which are shown in detail in the next sections.

1. Choose a certificate authority (CA).
2. Generate the following items on each switch:
  - a. A public and private key by using the **secCertUtil genkey** command.
  - b. A certificate signing request (CSR) by using the **secCertUtil gencsr** command.
3. Store the CSR on a file server by using the **secCertUtil export** command.
4. Obtain the certificates from the CA.

You can request a certificate from a CA through a Web browser. After you request a certificate, the CA either sends certificate files by e-mail (public) or gives access to them on a remote host (private). Typically, the CA provides the certificate files listed in [Table 21](#). Brocade supports .pem, .crt, and .cer files from the Certificate Authority.

**TABLE 21** SSL certificate files

Certificate file	Description
<i>name.crt</i>	The switch certificate.
<i>nameRoot.crt</i>	The root certificate. Typically, this certificate is already installed in the browser, but if not, you must install it.
<i>nameCA.crt</i>	The CA certificate. It must be installed in the browser to verify the validity of the server certificate or server validation fails.

5. On each switch, install the certificate. Once the certificate is loaded on the switch, HTTPS starts automatically.
6. If necessary, install the root certificate to the browser on the management workstation.
7. Add the root certificate to the Java Plug-in keystore on the management workstation.

## Certificate authorities

To ease maintenance and allow secure out-of-band communication between switches, consider using one certificate authority (CA) to sign all management certificates for a fabric. If you use different CAs, management services operate correctly, but the Web Tools **Fabric Events** button is unable to retrieve events for the entire fabric.

Each CA (for example, Verisign or GeoTrust) has slightly different requirements; for example, some generate certificates based on IP address, while others require an FQDN, and most require a 1024-bit public/private key while some may accept a 2048-bit key. Consider your fabric configuration, check CA Web sites for requirements, and gather all the information that the CA requires.

### *Generating a public and private key*

Perform this procedure on each switch.

1. Connect to the switch and log in as admin.
2. Enter the **secCertUtil genkey** command to generate a public/private key pair.  
The system reports that this process will disable secure protocols, delete any existing CSR, and delete any existing certificates.
3. Respond to the prompts to continue and select the key size.

#### **Example of generating a key**

```
Continue (yes, y, no, n): [no] y
Select key size [1024 or 2048]: 1024
Generating new rsa public/private key pair
Done.
```

Because CA support for the 2048-bit key size is limited, you should select 1024 in most cases.

### *Generating and storing a CSR*

After generating a public/private key, perform this procedure on each switch.

1. Connect to the switch and log in as admin.
2. Enter the **secCertUtil gencsr** command.
3. Enter the requested information.

#### **Example of generating a CSR**

```
Country Name (2 letter code, eg, US):US
State or Province Name (full name, eg, California):California
Locality Name (eg, city name):San Jose
Organization Name (eg, company name):Brocade
Organizational Unit Name (eg, department name):Eng
Common Name (Fully qualified Domain Name, or IP address): 192.1.2.3
Generating CSR, file name is: 192.1.2.3.csr
Done.
```

Your CA may require specific codes for Country, State or Province, Locality, Organization, and Organizational Unit names. Make sure that your spelling is correct and matches the CA requirements. If the CA requires that the Common Name be specified as an FQDN, make sure that the fully qualified domain name is set on the domain name server. The IP address or FQDN will be the server where the certificate will be put on.

4. Enter the **secCertUtil export** command to store the CSR:
5. Enter the requested information. You can use either FTP or SCP.

#### **Example of exporting a CSR**

```
Select protocol [ftp or scp]: ftp
Enter IP address: 192.1.2.3
Enter remote directory: path_to_remote_directory
Enter Login Name: your account
Enter Password: your password
Success: exported CSR.
```

If you are setup for secure file copy protocol, you can select it; otherwise, select ftp. Enter the IP address of the switch on which you generated the CSR. Enter the remote directory name of the FTP server to which the CSR is to be sent. Enter your account name and password on the server.

### *Obtaining certificates*

Check the instructions on the CA Web site; then, perform this procedure for each switch.

1. Generate and store the CSR as described in “[Generating and storing a CSR](#)” on page 124.
2. Open a Web browser window on the management workstation and go to the CA Web site. Follow the instructions to request a certificate. Locate the area in the request form into which you are to paste the CSR.
3. Through a Telnet window, connect to the switch and log in as admin.
4. Enter the **secCertUtil showcsr** command. The contents of the CSR are displayed.
5. Locate the section that begins with “BEGIN CERTIFICATE REQUEST” and ends with “END CERTIFICATE REQUEST”.
6. Copy and paste this section (including the BEGIN and END lines) into the area provided in the request form; then, follow the instructions to complete and send the request.

It may take several days to receive the certificates. If the certificates arrive by e-mail, save them to an FTP server. If the CA provides access to the certificates on an FTP server, make note of the path name and make sure you have a login name and password on the server.

### *Installing a switch certificate*

Perform this procedure on each switch.

1. Connect to the switch and log in as admin.
2. Enter the **secCertUtil import** command.
3. Select a protocol, enter the IP address of the host on which the switch certificate is saved, and enter your login name and password.

#### **Example of installing a switch certificate**

```
Select protocol [ftp or scp]: ftp
Enter IP address: 192.10.11.12
Enter remote directory: path_to_remote_directory
Enter certificate name (must have ".crt" suffix):192.1.2.3.crt
Enter Login Name: your_account
Enter Password: *****
Success: imported certificate [192.1.2.3.crt].
```

Once the certificate is loaded on the switch, HTTPS starts automatically.

## **The browser**

The root certificate may already be installed on your browser, if not, you must install it. To see whether it is already installed, check the certificate store on your browser.

The next procedures are guides for installing root certificates to Internet Explorer and Mozilla Firefox browsers. For more detailed instructions, refer to the documentation that came with the certificate.

### *Checking and installing root certificates on Internet Explorer*

1. Select **Tools > Internet Options**.
2. Click the **Content** tab.
3. Click **Certificates**.
4. Click the **Intermediate** or **Trusted Root** tabs and scroll the list to see if the root certificate is listed. Take the appropriate following action based on whether you find the certificate:
  - If the certificate is listed, you do not need to install it. You can skip the rest of this procedure.
  - If the certificate is not listed, click **Import**.
5. Follow the instructions in the Certificate Import wizard to import the certificate.

### *Checking and installing root certificates on Mozilla Firefox*

1. Select **Tools > Options**.
2. Click **Advanced**.
3. Click the **Encryption** tab.
4. Click **View Certificates > Authorities** tab and scroll the list to see if the root certificate is listed. For example, its name may have the form *nameRoot.crt*. Take the appropriate following action based on whether you find the certificate:
  - If the certificate is listed, you do not need to install it. You can skip the rest of this procedure.
  - If the certificate is not listed, click **Import**.
5. Browse to the certificate location and select the certificate. For example, select *nameRoot.crt*.
6. Click **Open** and follow the instructions to import the certificate.

## Root certificates for the Java Plug-in

For information on Java requirements, see “[Browser and Java support](#)” on page 122.

This procedure is a guide for installing a root certificate to the Java Plug-in on the management workstation. If the root certificate is not already installed to the plug-in, you should install it. For more detailed instructions, refer to the documentation that came with the certificate and to the Sun Microsystems Web site ([www.sun.com](http://www.sun.com)).

### *Installing a root certificate to the Java Plug-in*

1. Copy the root certificate file from its location on the FTP server to the Java Plug-in bin. For example, the bin location may be:

```
C: \program files\java\j2re1.6.0\bin
```

2. Open a Command Prompt window and change the directory to the Java Plug-in bin.

3. Enter the **keytool** command and respond to the prompts.

#### Example of installing a root certificate

```
C:\Program Files\Java\j2re1.6.0\bin> keytool -import -alias RootCert -file
RootCert.crt -keystore ..\lib\security\RootCerts
Enter keystore password: changeit
Owner: CN=Brocade, OU=Software, O=Brocade Communications, L=San Jose,
ST=California, C=US
Issuer: CN=Brocade, OU=Software, O=Brocade Communications, L=San Jose,
ST=California, C=US
Serial number: 0
Valid from: Thu Jan 15 16:27:03 PST 2007 until: Sat Feb 14 16:27:03 PST 2007
Certificate fingerprints:
    MD5: 71:E9:27:44:01:30:48:CC:09:4D:11:80:9D:DE:A5:E3
    SHA1: 06:46:C5:A5:C8:6C:93:9C:FE:6A:C0:EC:66:E9:51:C2:DB:E6:4F:A1
Trust this certificate? [no]: yes
Certificate was added to keystore
```

In the example, **changeit** is the default password and **RootCert** is an example root certificate name.

## Simple Network Management Protocol

The Simple Network Management Protocol (SNMP) is a standard method for monitoring and managing network devices. Using SNMP components, you can program tools to view, browse, and manipulate Brocade switch variables and set up enterprise-level management processes.

Every Brocade switch carries an SNMP agent and management information base (MIB). The agent accesses MIB information about a device and makes it available to a network management station. You can manipulate information of your choice by *trapping* MIB elements using the Fabric OS command line interface (CLI), Web Tools, or DCFM.

The SNMP access control list (ACL) provides a way for the administrator to restrict SNMP get, set, trap, and inform operations to certain hosts and IP addresses. This is used for enhanced management security in the storage area network.

For details on Brocade MIB files, naming conventions, loading instructions, and information about using Brocade's SNMP agent, see the *Fabric OS MIB Reference*.

You can configure SNMPv3 and SNMPv1 for the automatic transmission of SNMP information to management stations.

The configuration process involves configuring the SNMP agent and configuring SNMP traps. Use the **snmpConfig** command to configure the SNMP agent and traps for SNMPv3 or SNMPv1 configurations, and the security level. You can specify no security, authentication only, or authentication and privacy.

The SNMP trap configuration specifies the MIB trap elements to be used to send information to the SNMP management station. There are two main MIB trap choices:

- Brocade-specific MIB trap  
Associated with the Brocade-specific MIB (SW-MIB), this MIB monitors Brocade switches specifically.
- FibreAlliance MIB trap  
Associated with the FibreAlliance MIB (FA-MIB), this MIB manages SAN switches and devices from any company that complies with FibreAlliance specifications.

If you use both SW-MIB and FA-MIB, you may receive duplicate information. You can disable the FA-MIB, but not the SW-MIB.

You can also use these additional MIBs and their associated traps:

- FICON-MIB (for FICON environments)
- SW-EXTTRAP  
Includes the swSsn (Software Serial Number) as a part of Brocade SW traps.

For information on Brocade MIBs, see the *Fabric OS MIB Reference*.

For information on the specific commands used in these procedures, see online help or the *Fabric OS Command Reference*.

## SNMP and Virtual Fabrics

When an SNMPv3 request arrives with a particular username, it executes in the home Virtual Fabric. From the SNMP manager all SNMPv3 requests must have a home Virtual Fabric that is specified in the *contextName* field. Whenever the home Virtual Fabric is specified, it will be converted to the corresponding switch ID and the home Virtual Fabric will be set. If the user does not have permission for the specified home Virtual Fabric, this request fails with an error code of *noAccess*.

For an SNMPv3 user to have a home Virtual Fabric, a list of allowed Virtual Fabrics, an RBAC role, and the name of the SNMPv3 user should match that of the Fabric OS user in the local switch database. SNMPv3 users whose names do not match with any of the existing Fabric OS local users have a default RBAC role of admin with the SNMPv3 user access control of read/write. Their SNMPv3 user logs in with an access control of read-only. Both user types will have the default switch as their home Virtual Fabrics.

The *contextName* field should have the format “VF:xxx” where xxx is the actual VF\_ID, for example “VF:1”. If the *contextName* field is empty, then the home Virtual Fabric of the local Fabric OS user with the same name is used. As Virtual Fabrics and Admin Domains are mutually exclusive, this field is considered as Virtual Fabrics context whenever Virtual Fabrics is enabled. You cannot specify chassis context in the *contextName* field.

The following example shows how the VF:xx field is used in the **snmpwalk** command. The **snmpwalk** command is executed on the host and it walks the entire MIB tree specified (.1).

```
#snmpwalk -u admin -v 3 -n VF:4 192.168.176.181 .1
```

### *Filtering ports*

Each port can belong to only one Virtual Fabric at any time. An SNMP request coming to one Virtual Fabric can only view the port information of the ports belonging to that Virtual Fabric. All port attributes are filtered to allow SNMP to obtain the port information only from within the current Virtual Fabrics context.

### *Switch and Chassis context enforcement*

All attributes are classified into one of two categories:

- Chassis-level attributes
- Switch-level attributes



Attributes that are specific to each logical switch belong to the switch category. These attributes are available in the Virtual Fabrics context and not available in the Chassis context.

Attributes that are common across the logical switches belong to the chassis level. These attributes are accessible to users having the chassis-role permission. When a chassis table is queried the context is set to chassis context, if the user has the chassis-role permission. The context is switched back to the original context after the operation is performed.

## The security level

Use the `snmpConfig --set seclevel` command to set the security level. For more information about using the Brocade SNMP agent, see the *Fabric OS MIB Reference*.

## The snmpConfig command

Use the `snmpConfig --set` command to change either the SNMPv3 or SNMPv1 configuration. You can also change access control, MIB capability, and system group.

For details on Brocade MIB files, naming conventions, loading instructions, and information about using the Brocade SNMP agent, see the *Fabric OS MIB Reference*.

# Telnet protocol

Telnet is enabled by default. To prevent passing clear text passwords over the network when connecting to the switch, you can block the Telnet protocol using an IP Filter policy. For more information on IP Filter policies, refer to “[IP Filter policy](#)” on page 153.

---

### ATTENTION

Before blocking Telnet, make sure you have an alternate method of establishing a connection with the switch.

---

## Blocking Telnet

If you create a new policy using commands with just one rule, all the missing rules have an implicit deny and you lose all IP access to the switch, including Telnet, SSH, and management ports.

1. Connect to the switch and log in as admin.
2. Clone the default policy by typing the `ipFilter --clone` command.
 

```
switch:admin> ipfilter --clone BlockTelnet -from default_ipv4
```

3. Save the new policy by typing the `ipFilter --save` command.

```
switch:admin> ipfilter --save BlockTelnet
```

4. Verify the new policy exists by typing the `ipFilter --show` command.

```
switch:admin> ipfilter --show
```

5. Add a rule to the policy, by typing the `ipFilter --addrule` command.

```
switch:admin> ipfilter --addrule BlockTelnet -rule 1 -sip any -dp 23 -proto
tcp -act deny
```

**ATTENTION**

The rule number assigned has to precede the default rule number for this protocol. For example, in the defined policy, the Telnet rule number is 2, therefore to effectively block Telnet, the rule number to assign must be 1.

If you choose not to use 1, you will need to delete the telnet rule number 2 after adding this rule. Refer to [“Deleting a rule to an IP Filter policy”](#) on page 157 for more information on deleting IP filter rules.

6. Save the new ipfilter policy by typing the **ipfilter --save** command.
7. Verify the new policy is correct by typing the **ipFilter --show** command.
8. Activate the new ipfilter policy by typing the **ipfilter --activate** command.

```
switch:admin> ipfilter --activate BlockTelnet
```

9. Verify the new policy is active (the default\_ipv4 policy should be displayed as *defined*).

```
switch:admin> ipfilter --show
```

```
Name: BlockTelnet, Type: ipv4, State: defined
```

Rule	Source IP	Protocol	Dest Port	Action
<b>1</b>	<b>any</b>	<b>tcp</b>	<b>23</b>	<b>deny</b>
2	any	tcp	22	permit
3	any	tcp	22	permit
4	any	tcp	897	permit
5	any	tcp	898	permit
6	any	tcp	111	permit
7	any	tcp	80	permit
8	any	tcp	443	permit
9	any	udp	161	permit
10	any	udp	111	permit
11	any	udp	123	permit
12	any	tcp	600 - 1023	permit
13	any	udp	600 - 1023	permit

```
Name: default_ipv4, Type: ipv4, State: defined
```

Rule	Source IP	Protocol	Dest Port	Action
1	any	tcp	22	permit
2	any	tcp	23	permit
3	any	tcp	897	permit
4	any	tcp	898	permit
5	any	tcp	111	permit
6	any	tcp	80	permit
7	any	tcp	443	permit
8	any	udp	161	permit
9	any	udp	111	permit
10	any	udp	123	permit
11	any	tcp	600 - 1023	permit
12	any	udp	600 - 1023	permit

## Unblocking Telnet

1. Connect to the switch through a serial port or SSH and log in as admin.
2. Type in the **ipfilter --delete** command.

Refer to [“Deleting a rule to an IP Filter policy”](#) on page 157 for more information on deleting IP filter rules.

- To permanently delete the policy, type the `ipfilter --save` command.

---

**ATTENTION**

If you deleted the rule to permit Telnet, you will need to add a rule to permit Telnet.

---

## Listener applications

Brocade switches block Linux subsystem listener applications that are not used to implement supported features and capabilities. [Table 22](#) lists the listener applications that Brocade switches either block or do not start.

**TABLE 22** Blocked listener applications

Listener application	Brocade 48000 director and Brocade DCX enterprise-class platforms	Brocade 300, 4100, 4900, 5000, 5410, 5424, 5450, 5460, 5470, 5480, 5100, 5300, 5424, 7500, 7500E, 7600, 7800, 8000, and VA-40FC switches; FA4-18, FC4-16, FC4-16IP, FC4-32, FC4-48, FC8-16, FC8-32, FC8-48, FC10-6, FCOE10-24, FR4-18i, FS8-18, and FX8-24 blades
chargen	Disabled	Disabled
echo	Disabled	Disabled
daytime	Disabled	Disabled
discard	Disabled	Disabled
ftp	Disabled	Disabled
rexec	Block with packet filter	Disabled
rsh	Block with packet filter	Disabled
rlogin	Block with packet filter	Disabled
time	Block with packet filter	Disabled
rstats	Disabled	Disabled
rusers	Disabled	Disabled

## Ports and applications used by switches

If you are using the FC-FC Routing Service, be aware that the `secModeEnable` command is not supported in Fabric OS v6.1.0 and later.

[Table 23](#) lists the defaults for accessing hosts, devices, switches, and zones.

**TABLE 23** Access defaults

	Access default
Hosts	Any host can access the fabric by SNMP.
	Any host can Telnet to any switch in the fabric.
	Any host can establish an HTTP connection to any switch in the fabric.
	Any host can establish an API connection to any switch in the fabric.

**TABLE 23 Access defaults (Continued)**

	Access default
Devices	All devices can access the management server.
	Any device can connect to any FC port in the fabric.
Switch access	Any switch can join the fabric.
	All switches in the fabric can be accessed through a serial port.
Zoning	No zoning is enabled.

## Port configuration

Table 24 provides information on ports that the switch uses. When configuring the switch for various policies, take into consideration firewalls and other devices that may sit between switches in the fabric and your network or between the managers and the switch.

**TABLE 24 Port information**

Port	Type	Common use	Comment
22	TCP	SSH, SCP	
23	TCP	Telnet	Use the <b>ipfilter</b> command to block the port.
80	TCP	HTTP	Use the <b>ipfilter</b> command to block the port.
111	UDP	sunrpc	This port is used by Platform API. Use the <b>ipfilter</b> command to block the port.
123	UDP	NTP	
161	UDP	SNMP	Disable the SNMP service on the remote host if you do not use it, or filter incoming UDP packets going to this port.
443	TCP	HTTPS	Use the <b>ipfilter</b> command to block the port.
512	TCP	exec	
513	TCP	login	
514	TCP	shell	
897	TCP		This port is used by the Platform API.

# Configuring Security Policies

---

## In this chapter

- [ACL policies overview](#) ..... 133
- [ACL policy management](#) ..... 134
- [FCS policies](#) ..... 137
- [DCC policies](#) ..... 140
- [SCC policies](#) ..... 143
- [Authentication policy for fabric elements](#) ..... 144
- [IP Filter policy](#) ..... 153
- [Policy database distribution](#) ..... 158
- [Management interface security](#) ..... 164

## ACL policies overview

Each supported Access Control List (ACL) policy listed below is identified by a specific name, and only one policy of each type can exist, except for DCC policies. Policy names are case-sensitive and must be entered in all uppercase. Fabric OS provides the following policies:

- **Fabric configuration server** (FCS) policy — Used to restrict which switches can change the configuration of the fabric.
- **Device connection control** (DCC) policies — Used to restrict which Fibre Channel device ports can connect to which Fibre Channel switch ports.
- **Switch connection control** (SCC) policy — Used to restrict which switches can join with a switch.

---

### NOTE

Run all commands in this chapter by logging in to Administrative Domain (AD) 255 with the suggested role. If Administrative Domains have not been implemented, log in to ADO.

---

## How the ACL policies are stored

The policies are stored in a local database. The database contains the ACL policy types of FCS, DCC, SCC, and IPFilter. The number of policies that may be defined is limited by the size of the database. FCS, SCC and DCC policies are all stored in the same database.

In a fabric with Fabric OS v6.2.0 and later switches present, the limit for security policy database size is set to 1Mb. The policies are grouped by state and type. A policy can be in either of the following states:

- **Active**, which means the policy is being enforced by the switch.
- **Defined**, which means the policy has been set up but is not enforced.

Policies with the same state are grouped together in a *Policy Set*. Each switch has the following two sets:

- **Active policy set**, which contains ACL policies being enforced by the switch.
- **Defined policy set**, which contains a copy of all ACL policies on the switch.

When a policy is activated, the defined policy either replaces the policy with the same name in the active set or becomes a new active policy. If a policy appears in the defined set but not in the active set, the policy was saved but has not been activated. If a policy with the same name appears in both the defined and active sets but they have different values, then the policy has been modified but the changes have not been activated.

**Admin Domain considerations:** ACL management can be done on AD255 and in ADO only if there are no user-defined Admin Domains. Both ADO (when no other user-defined Admin Domains exist) and AD255 provide an unfiltered view of the fabric.

**Virtual Fabric considerations:** ACL policies such as DCC, SCC, and FCS can be configured on each logical switch. The limit for security policy database size is set to 1Mb per logical switch.

## Policy members

The FCS, DCC and SCC policy members are specified by device port WWN, switch WWN, domain IDs, or switch names, depending on the policy. The valid methods for specifying policy members are listed in [Table 25](#).

**TABLE 25** Valid methods for specifying policy members

Policy name	Device port WWN	Switch WWN	Domain ID	Switch name
FCS_POLICY	No	Yes	Yes	Yes
DCC_POLICY_nnn	Yes	Yes	Yes	Yes
SCC_POLICY	No	Yes	Yes	Yes

## ACL policy management

All policy modifications are temporarily stored in volatile memory until those changes are saved or activated. You can create multiple sessions to the switch from one or more hosts. It is recommended you make changes from one switch only to prevent multiple transactions from occurring. Each logical switch will have its own access control list.

The FCS, SCC and DCC policies in Secure Fabric OS are not interchangeable with Fabric OS FCS, SCC and DCC policies. Uploading and saving a copy of the Fabric OS configuration after creating policies is strongly recommended. For more information on configuration uploads, see the [Chapter 8, “Maintaining the Switch Configuration File”](#).

---

### NOTE

All changes, including the creation of new policies, are saved and activated on the local switch only—unless the switch is in a fabric that has a strict or tolerant fabric-wide consistency policy for the ACL policy type for SCC or DCC. See [“Policy database distribution”](#) on page 158 for more information on the database settings and fabric-wide consistency policy.

---

## Displaying ACL policies

You can view the active and defined policy sets at any time. Additionally, in a defined policy set, policies created in the same login session also appear but these policies are automatically deleted if the you log out without saving them.

1. Connect to the switch and log in using an account assigned to the admin role.
2. Type the **secPolicyShow** command.

```
switch:admin> secPolicyShow
```

---

ACTIVE POLICY SET

---

DEFINED POLICY SET

## Saving changes without activating the policies

1. Connect to the switch and log in using an account assigned to the admin role.
2. Enter the **secPolicySave** command.

## Activating policy changes

You can implement changes to the ACL policies using the **secPolicyActivate** command. This saves the changes to the active policy set and activates all policy changes since the last time the command was issued. You cannot activate policies on an individual basis; all changes to the entire policy set are activated by the command. Until a **secPolicySave** or **secPolicyActivate** command is issued, all policy changes are in volatile memory only and are lost upon rebooting.

1. Connect to the switch and log in using an account assigned to the admin role.
2. Type the **secPolicyActivate** command.

### Example of activating policy changes

```
switch:admin> secpolicyactivate
About to overwrite the current Active data.
ARE YOU SURE (yes, y, no, n): [no] y
```

## Deleting an ACL policy

1. Connect to the switch and log in using an account assigned to the admin role.
2. Type **secPolicyDelete** "*policy\_name*".  
where *policy\_name* is the name of the ACL policy.
3. Save and activate the policy deletion by entering the **secPolicyActivate** command.

### Example of deleting an ACL policy

```
switch:admin> secpolicydelete "DCC_POLICY_010"
About to delete policy Finance_Policy.
Are you sure (yes, y, no, n):[no] y
Finance_Policy has been deleted.
```

## Adding a member to an existing ACL policy

As soon as a policy has been activated, the aspect of the fabric managed by that policy is enforced.

1. Connect to the switch and log in using an account assigned to the admin role.
2. Enter the **secPolicyAdd** command.
3. To implement the change immediately, enter the **secPolicyActivate** command.

### Example of adding to an ACL policy

For example, to add a member to the SCC\_POLICY using the switch WWN:

```
switch:admin> secpolicyadd "SCC_POLICY", "12:24:45:10:0a:67:00:40"
Member(s) have been added to SCC_POLICY.
```

### Example of adding members to the DCC policy

To add two devices to the DCC policy, and to attach domain 3 ports 1 and 3 (WWNs of devices are 11:22:33:44:55:66:77:aa and 11:22:33:44:55:66:77:bb):

```
switch:admin> secpolicyadd "DCC_POLICY_abc",
"11:22:33:44:55:66:77:aa;11:22:33:44:55:66:77:bb;3 (1,3) "
```

## Removing a member from an ACL policy

As soon as a policy has been activated, the aspect of the fabric managed by that policy is enforced.

1. Connect to the switch and log in using an account assigned to the admin role.
2. Enter the **secPolicyRemove** command.
3. To implement the change immediately, enter the **secPolicyActivate** command.

### Example of removing a member

For example, to remove a member that has a WWN of 12:24:45:10:0a:67:00:40 from the SCC\_POLICY:

```
switch:admin> secpolicyremove "SCC_POLICY", "12:24:45:10:0a:67:00:40"
Member(s) have been removed from SCC_POLICY.
```

## Aborting unsaved policy changes

You can abort all ACL policy changes that have not yet been saved.

1. Connect to the switch and log in using an account assigned to the admin role.
2. Enter the **secPolicyAbort** command.

### Example of aborting unsaved changes

```
switch:admin> secpolicyabort
Unsaved data has been aborted.
```

All changes since the last time the **secPolicySave** or **secPolicyActivate** commands were entered are aborted.



## FCS policies

Fabric Configuration Server (FCS) policy in base Fabric OS may be performed on a local switch basis and may be performed on any switch in the fabric.

The FCS policy is not present by default, but must be created. When the FCS policy is created, the WWN of the local switch is automatically included in the FCS list. Additional switches can be included in the FCS list. The first switch in the list becomes the Primary FCS switch.

Switches in the fabric are designated as either a Primary FCS, backup FCS, or non-FCS switch. Only the Primary FCS switch is allowed to modify and distribute the database within the fabric. Automatic distribution is supported and you can either configure the switches in your fabric to accept the FCS policy or manually distribute the FCS policy. Changes made to the FCS policy are saved to permanent memory only after the changes have been saved or activated; they can be aborted later if you have set your fabric to distribute the changes manually.

**TABLE 26 FCS policy states**

Policy state	Characteristics
No active policy	Any switch can perform fabric-wide configuration changes.
Active policy with one entry	A Primary FCS switch is designated (local switch), but there are no backup FCS switches. If the Primary FCS switch becomes unavailable for any reason, the fabric is left without an FCS switch.
Active policy with multiple entries	A Primary FCS switch and one or more backup FCS switches are designated. If the Primary FCS switch becomes unavailable, the next switch in the list becomes the Primary FCS switch.

### FCS policy restrictions

The backup FCS switches normally cannot modify the policy. However, if the Primary FCS switch in the policy list is not reachable, then a backup FCS switch is allowed to modify the policy.

Once an FCS policy is configured and distributed across the fabric, only the Primary FCS switch can perform certain operations. Operations that affect fabric-wide configuration are allowed only from the Primary FCS switch. Backup and non-FCS switches cannot perform security, zoning and AD operations that affect the fabric configuration. The following error message is returned if a backup or non-FCS switch tries to perform these operations:

*Can only execute this command on the Primary FCS switch.*

Operations that do not affect the fabric configuration, such as *show* or local switch commands, are allowed on backup and non-FCS switches.

FCS enforcement applies only for user-initiated fabric-wide operations. Internal fabric data propagation because of a fabric merge is not blocked. Consequently, a new switch that joins the FCS-enabled fabric could still propagate the AD and zone database.

[Table 27](#) on page 138 shows the commands for switch operations for Primary FCS enforcement.

TABLE 27 FCS switch operations

Allowed on FCS switches	Allowed on all switches
secPolicyAdd (Allowed on all switches for SCC and DCC policies as long as it is not fabric-wide)	secPolicyShow
secPolicyCreate (Allowed on all switches for SCC and DCC policies as long as it is not fabric-wide)	fddCfg --localaccept or fddCfg --localreject
secPolicyDelete (Allowed on all switches for SCC and DCC policies as long as its not fabric-wide)	userconfig, Passwd, Passwdcfg (Fabric-wide distribution is not allowed from a backup or non-FCS switch.)
secPolicyRemove (Allowed on all switches for SCC and DCC policies as long as its not fabric-wide)	secPolicyActivate
fddCfg --fabwideset	secPolicySave
Any fabric-wide commands	secPolicyAbort
All zoning commands except the show commands	SNMP commands
All AD commands	configupload
	Any local-switch commands
	Any AD command that does not affect fabric-wide configuration

## Ensuring fabric domains share policies

Whether your intention is to create new FCS policies or manage your current FCS policies, you must follow certain steps to ensure the domains throughout your fabric have the same policy.

The local-switch WWN cannot be deleted from the FCS policy.

1. Create the FCS policy using the **secPolicyCreate** command.
2. Activate the policy using the **secPolicyActivate** command.

If the command is not entered, the changes are lost when the session is logged out.

3. To distribute the policies, enter the **distribute -p policy\_list -d switch\_list** command to either send the policies to intended domains, or enter the **distribute -p policy\_list -d wild\_card (\*)** command to send the policies to all switches.

## Creating an FCS policy

1. Connect to the switch and log in using an account assigned to the admin role.
2. Enter the **secPolicyCreate "FCS\_POLICY"** command.

### Example of creating an FCS policy

The following example creates an FCS policy that allows a switch with domain ID 2 to become a primary FCS and domain ID 4 to become a backup FCS:

```
switch:admin> secpolicycreate "FCS_POLICY", "2;4"
FCS_POLICY has been created
```

3. To save or activate the new policy, enter either the **secPolicySave** or the **secPolicyActivate** command. Once the policy has been activated you can distribute the policy.

**NOTE**

FCS policy must be consistent across the fabric. If the policy is inconsistent in the fabric, then you will not be able to perform any fabric-wide configurations from the primary FCS.

## Modifying the order of FCS switches

1. Log in to the Primary FCS switch using an account assigned to the admin role.
2. Type **secPolicyShow “Defined”, “FCS\_POLICY”**.

This displays the WWNs of the current Primary FCS switch and backup FCS switches.

3. Type **secPolicyFCSMove**; then provide the current position of the switch in the list and the desired position at the prompts.

Alternatively, enter **secPolicyFCSMove [From, To]** command. *From* is the current position in the list of the FCS switch and *To* is the desired position in the list for this switch.

### Example of moving an FCS policy

The following example moves a backup FCS switch from position 2 to position 3 in the FCS list, using interactive mode:

```
primaryfcs:admin> secpolicyfcsmove
PosPrimary WWN                               DIid   swName.
=====
1Yes  10:00:00:60:69:10:02:181  switch5.
2No   10:00:00:60:69:00:00:5a2  switch60.
3No   10:00:00:60:69:00:00:133  switch73.
Please enter position you'd like to move from : (1..3) [1] 2
Please enter position you'd like to move to : (1..3) [1] 3

-----
DEFINED POLICY SET
FCS_POLICY
PosPrimaryWWN                               DIid swName
-----
1Yes  10:00:00:60:69:10:02:181 switch5.
2No   10:00:00:60:69:00:00:133 switch73.
3No   10:00:00:60:69:00:00:5a2 switch60.
-----
```

4. Type the **secPolicyActivate** command to activate and save the new order.

## FCS policy distribution

The FCS policy can be automatically distributed using the **fddCfg --fabwideset** command or it can be manually distributed to the switches using the **distribute -p** command. Each switch that receives the FCS policy must be configured to receive the policy. To configure the switch to accept distribution of the FCS policy, refer to [“Database distribution settings”](#) on page 159.

Database distributions may be initiated from only the Primary FCS switch. FCS policy configuration and management is performed using the command line or a manageability interface.

Only the Primary FCS switch is allowed to distribute the database. The FCS policy may need to be manually distributed across the fabric using the **distribute -p** command. Since this policy is distributed manually, the command **fddCfg --fabwideset** is used to distribute a fabric-wide consistency policy for FCS policy in an environment consisting of only Fabric OS v6.2.0 and later switches.

FCS enforcement for the **distribute** command is handled differently for FCS and other databases in an FCS fabric:

- For an FCS database, the enforcement allows any switch to initiate the distribution. This is to support FCS policy creation specifying a remote switch as Primary.
- For other database distributions, only the Primary FCS switch can initiate the distribution.

The FCS policy distribution is allowed to be distributed from a switch in the FCS list. However, if none of the FCS switches in the existing FCS list are reachable, receiving switches accept distribution from any switch in the fabric. To learn more about how to distribute policies, refer to [“ACL policy distribution to other switches”](#) on page 160.

Local switch configuration parameters are needed to control whether a switch accepts or rejects distributions of FCS policy and whether the switch is allowed to initiate distribution of an FCS policy. A configuration parameter controls whether the distribution of the policy is accepted or rejected on the local switch. Setting the configuration parameter to accept indicates distribution of the policy will be accepted and distribution may be initiated using the **distribute -p** command. Setting the configuration parameter to reject indicates the policy distribution is rejected and the switch may not distribute the policy.

The default value for the distribution configuration parameter is *accept*, which means the switch accepts all database distributions and is able to initiate a distribute operation for all databases.

**TABLE 28** Distribution policy states

Fabric OS	State
v6.2.0 and later configured to accept	Target switch accepts distribution and fabric state change occurs.
v6.2.0 and later configured to reject	Target switch explicitly rejects the distribution and the operation fails. The entire transaction is aborted and no fabric state change occurs.

## DCC policies

Multiple DCC policies can be used to restrict which device ports can connect to which switch ports. The devices can be initiators, targets, or intermediate devices such as SCSI routers and loop hubs. By default, all device ports are allowed to connect to all switch ports; no DCC policies exist until they are created. For information regarding DCC policies and F\_Port trunking, refer to the *Access Gateway Administrator's Guide*.

Each device port can be bound to one or more switch ports; the same device ports and switch ports may be listed in multiple DCC policies. After a switch port is specified in a DCC policy, it permits connections only from designated device ports. Device ports that are not specified in any DCC policies are allowed to connect only to switch ports that are not specified in any DCC policies.

When a DCC violation occurs, the related port is automatically disabled and must be re-enabled using the **portEnable** command.

[Table 29](#) on page 141 shows the possible DCC policy states.

**TABLE 29** DCC policy states

Policy state	Characteristics
No policy	Any device can connect to any switch port in the fabric.
Policy with no entries	Any device can connect to any switch port in the fabric. An empty policy is the same as no policy.
Policy with entries	<p>If a device WWN is specified in a DCC policy, that device is only allowed access to the switch if connected by a switch port listed in the same policy.</p> <p>If a switch port is specified in a DCC policy, it only permits connections from devices that are listed in the policy.</p> <p>Devices with WWNs that are not specified in a DCC policy are allowed to connect to the switch at any switch ports that are not specified in a DCC policy.</p> <p>Switch ports and device WWNs may exist in multiple DCC policies.</p> <p>Proxy devices are always granted full access and can connect to any switch port in the fabric.</p>

**Virtual Fabric considerations:** The DCC policies that have entries for the ports that are being moved from one logical switch to another will be considered *stale* and will not be enforced. You can choose to keep *stale* policies in the current logical switch or delete the *stale* policies after the port movements. Use the **secPolicyDelete** command to delete stale DCC policies.

## DCC policy restrictions

The following restrictions apply when using DCC policies:

- Some older private-loop HBAs do not respond to port login from the switch and are not enforced by the DCC policy. This does not create a security problem because these HBAs cannot contact any device outside of their immediate loop.
- DCC policies cannot manage or restrict iSCSI connections, that is, an FC Initiator connection from an iSCSI gateway.
- You cannot manage proxy devices with DCC policies. Proxy devices are always granted full access, even if the DCC policy has an entry that restricts or limits access of a proxy device.
- DCC policies are not supported on the CEE ports of the Brocade 8000.

## Creating a DCC policy

DCC policies must follow the naming convention “DCC\_POLICY\_*nnn*,” where *nnn* represents a unique string. The maximum length is 30 characters, including the prefix DCC\_POLICY\_.

Device ports must be specified by port WWN. Switch ports can be identified by the switch WWN, domain ID, or switch name followed by the port or area number. To specify an allowed connection, enter the device port WWN, a semicolon, and the switch port identification.

The following methods of specifying an allowed connection are possible:

- *deviceportWWN;switchWWN* (port or area number)
- *deviceportWWN;domainID* (port or area number)
- *deviceportWWN;switchname* (port or area number)

1. Connect to the switch and log in using an account assigned to the admin role.
2. Enter the **secPolicyCreate** “DCC\_POLICY\_*nnn*” command.

DCC\_POLICY\_ *nnn* is the name of the DCC policy; *nnn* is a string consisting of up to 19 alphanumeric or underscore characters to differentiate it from any other DCC policies.

3. To save or activate the new policy, enter the appropriate command:
  - To save the policy, enter the **secPolicySave** command.
  - To save and activate the policy, enter the **secPolicyActivate** command.

If neither of these commands is entered, the changes are lost when the session is logged out.

#### Example s of creating DCC policies

To create the DCC policy "DCC\_POLICY\_server" that includes device 11:22:33:44:55:66:77:aa and port 1 and port 3 of switch domain 1:

```
switch:admin> secpolicycreate
"DCC_POLICY_server", "11:22:33:44:55:66:77:aa;1 (1,3) "
DCC_POLICY_server has been created
```

To create the DCC policy "DCC\_POLICY\_storage" that includes device port WWN 22:33:44:55:66:77:11:bb, all ports of switch domain 2, and all currently connected devices of switch domain 2:

```
switch:admin> secpolicycreate "DCC_POLICY_storage",
"22:33:44:55:66:77:11:bb;2[*]"
DCC_POLICY_storage has been created
```

To create the DCC policy "DCC\_POLICY\_abc" that includes device 33:44:55:66:77:11:22:cc and ports 1 through 6 and port 9 of switch domain 3:

```
switch:admin> secpolicycreate "DCC_POLICY_abc",
"33:44:55:66:77:11:22:cc;3 (1-6,9) "
DCC_POLICY_abc has been created
```

To create the DCC policy "DCC\_POLICY\_example" that includes devices 44:55:66:77:22:33:44:dd and 33:44:55:66:77:11:22:cc, ports 1 through 4 of switch domain 4, and all devices currently connected to ports 1 through 4 of switch domain 4:

```
switch:admin> secpolicycreate "DCC_POLICY_example",
"44:55:66:77:22:33:44:dd;33:44:55:66:77:11:22:cc;4 [1-4] "
DCC_POLICY_example has been created
```

## Deleting a DCC policy

1. Connect to the switch and log in using an account assigned to the admin role.
2. Enter the **secPolicyDelete** command.

#### Example of deleting stale DCC policies

```
switch:admin> secpolicydelete ALL_STALE_DCC_POLICY
About to clear all STALE DCC policies
ARE YOU SURE (yes, y, no, n): [no] y
```

## SCC policies

The switch connection control (SCC) policy is used to restrict which switches can join the fabric. Switches are checked against the policy each time an E\_Port-to-E\_Port connection is made. The policy is named SCC\_POLICY and accepts members listed as WWNs, domain IDs, or switch names. Only one SCC policy can be created.

By default, any switch is allowed to join the fabric; the SCC policy does not exist until it is created. When connecting a Fibre Channel router to a fabric or switch that has an active SCC policy, the front domain of the Fibre Channel router must be included in the SCC policy.

SCC policy states are shown in [Table 30](#).

**TABLE 30** SCC policy states

Policy state	SCC policy enforcement
No active policy	All switches can connect to the switch with the specified policy.
Active policy that has no members	All neighboring switches are segmented.
Active policy that has members	The neighboring switches not specified in the SCC policy are segmented.

**Virtual Fabric considerations:** In a logical fabric environment the SCC policy enforcement is not done on the logical ISL. For a logical ISL-based switch, the SCC policy enforcement is considered as the reference and the logical ISL is formed if the SCC enforcement passes on the extended ISL. The following functionality changes:

- A logical switch supports an SCC policy. You can configure and distribute an SCC policy on a logical switch.
- SCC enforcement is performed on a ISL based on the SCC policy present on the logical switch.

For more information on Virtual Fabrics, refer to [Chapter 10, “Managing Virtual Fabrics”](#).

### Creating an SCC policy

1. Connect to the switch and log in using an account assigned to the admin role.
2. Enter the `secPolicyCreate “SCC_POLICY”` command.
3. Save or activate the new policy by entering either the `secPolicySave` or the `secPolicyActivate` command.

If neither of these commands is entered, the changes are lost when the session is logged out.

#### Example of creating an SCC policy

For example, to create an SCC policy that allows switches that have domain IDs 2 and 4 to join the fabric:

```
switch:admin> secpolicycreate "SCC_POLICY", "2;4"
SCC_POLICY has been created
switch:admin> secpolycysave
```

## Authentication policy for fabric elements

By default, Fabric OS v6.2.0 and later use DH-CHAP or FCAP protocols for authentication. These protocols use shared secrets and digital certificates, based on switch WWN and public key infrastructure (PKI) technology, to authenticate switches. Authentication automatically defaults to FCAP if both switches are configured to accept FCAP protocol in authentication. To use FCAP on both switches, PKI certificates have to be installed.

---

### NOTE

The fabric authentication feature is available in base Fabric OS. No license is required.

---

FCAP requires the exchange of certificates between two or more switches to authenticate to each other before they form or join a fabric. By default, these certificates are issued by Brocade, and therefore Brocade is the root CA for all of the issued certificates. You can change the default by getting your certificates from a third-party vendor. You can use Brocade certificates between the switches that are Fabric OS v6.4.0 and pre-v6.4.0. The certificates must be in PEM (Privacy Enhanced Mail) encoded format for both root and peer certificates. The switch certificates issued from the third-party vendors can be directly issued from the root CA or from an intermediate CA authority.

You can configure a switch with Fabric OS v6.2.0 or later to use DH-CHAP for device authentication. When you configure DH-CHAP authentication, you also must define a *pair of shared secrets* known to both switches as a *secret key pair*. [Figure 16](#) illustrates how the secrets are configured. A *secret key pair* consists of a local secret and a peer secret. The local secret uniquely identifies the local switch. The peer secret uniquely identifies the entity to which the local switch authenticates. Every switch can share a *secret key pair* with any other switch or host in a fabric.

To use DH-CHAP authentication, a *secret key pair* has to be configured on both switches. For more information on setting up secret key pairs, refer to [“Setting a secret key pair”](#) on page 149.

When configured, the *secret key pair* is used for authentication. Authentication occurs whenever there is a state change for the switch or port. The state change can be due to a switch reboot, a switch or port disable and enable, or the activation of a policy.

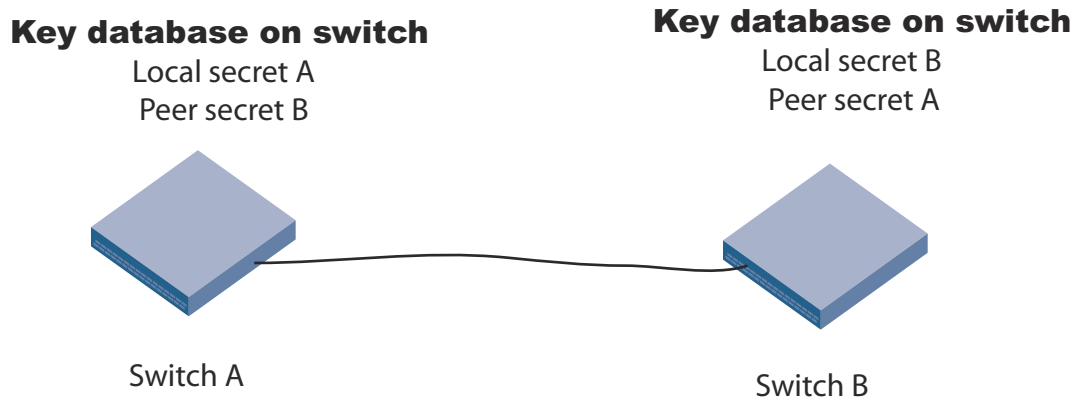

**FIGURE 16** DH-CHAP authentication

If you use DH-CHAP authentication, then a *secret key pair* must be installed only in connected fabric elements. However, as connections are changed, new *secret key pairs* must be installed between newly connected elements. Alternatively, a *secret key pair* for all possible connections may be initially installed, enabling links to be arbitrarily changed while still maintaining a valid *secret key pair* for any new connection.



The switch authentication (AUTH) policy initiates DH-CHAP/FCAP authentication on all E\_Ports. This policy is persistent across reboots, which means authentication will be initiated automatically on ports or switches brought online if the policy is set to activate authentication. The AUTH policy is distributed by command; automatic distribution of the AUTH policy is not supported.

The default configuration directs the switch to attempt FCAP authentication first, DH-CHAP second. The switch may be configured to negotiate FCAP, DH-CHAP, or both.

The DH group is used in the DH-CHAP protocol only. The FCAP protocol exchanges the DH group information, but does not use it.

**Virtual Fabric considerations:** If a Virtual Fabric is enabled, all AUTH module parameters such as shared secrets, and shared switch and device policies, are logical switch-wide. That means you must configure shared secrets and policies separately on each logical switch and the shared secrets and policies must be set on each switch prior to authentication. On logical switch creation, authentication takes default values for policies and other parameters. FCAP certificates are installed on a chassis, but are configured on each logical switch.

## E\_Port authentication

The authentication (AUTH) policy allows you to configure DH-CHAP authentication on switches with Fabric OS v5.3.0 and later. By default the policy is set to PASSIVE and you can change the policy. All changes to the AUTH policy take effect during the next authentication request. This includes starting authentication on all E\_Ports on the local switch if the policy is changed to ON or ACTIVE, and clearing the authentication if the policy is changed to OFF. The authentication configurations will be effective only on subsequent E\_ and F\_Port initialization.

---

### ATTENTION

A *secret key pair* has to be installed prior to changing the policy. For more information on setting up secret key pairs, refer to [“Setting a secret key pair”](#) on page 149.

---

**Virtual Fabric considerations:** The switch authentication policy applies to all E\_Ports in a logical switch. This includes ISLs and extended ISLs. Authentication of extended ISLs between two base switches is considered peer-chassis authentication. Authentication between two physical entities is required, so the extended ISL which connects the two chassis needs to be authenticated. The corresponding extended ISL for a logical ISL authenticates the peer-chassis, therefore the logical ISL authentication is not required. Because the logical ISLs do not carry actual traffic, they do not need to be authenticated. Authentication on re-individualization is also blocked on logical ISLs. The following error message is printed on the console when you execute the `authUtil --authinit` command on logical-ISLs, “Failed to initiate authentication. Authentication is not supported on logical ports <port#>”. For more information on Virtual Fabrics, refer to [Chapter 10, “Managing Virtual Fabrics”](#).

### *Configuring E\_Port authentication*

1. Connect to the switch and log in using an account assigned to the admin role.
2. Enter the `authUtil` command to set the switch policy mode.

#### **Example of configuring E\_Port authentication**

The following example shows how to enable a Virtual Fabric and configure the E\_Ports to perform authentication using the AUTH policies `authUtil` command.

```
switch:admin> fosconfig -enable vf
```

## 7 Authentication policy for fabric elements

```
WARNING: This is a disruptive operation that requires a reboot to take
effect.
All EX ports will be disabled upon reboot.
Would you like to continue [Y/N] y
```

```
switch:admin> authutil --authinit 2,3,4
```



### CAUTION

If data input has not been completed and a failover occurs, the command is terminated without completion and your entire input is lost.

If data input has completed, the enter key pressed, and a failover occurs, data may or may not be replicated to the other CP depending on the timing of the failover. Log in to the other CP after the failover is complete and verify the data was saved. If data was not saved, run the command again.

#### Example of setting the policy to active mode

```
switch:admin> authutil --policy -sw active
Warning: Activating the authentication policy requires
either DH-CHAP secrets or PKI certificates depending
on the protocol selected. Otherwise, ISLs will be
segmented during next E-port bring-up.
ARE YOU SURE (yes, y, no, n): [no] y
Auth Policy is set to ACTIVE
```

### *Re-authenticating E\_Ports*

Use the command **authUtil** to re-initiate the authentication on selected ports. It provides flexibility to initiate authentication for specified E\_Ports, a set of E\_Ports, or all E\_Ports on the switch. This command does not work on loop, NPIV and FICON devices. The command **authUtil** can re-initiate authentication only if the device was previously authenticated. If the authentication fails because shared secrets do not match, the port is disabled.

This command works independently of the authentication policy; this means you can initiate the authentication even if the switch is in PASSIVE mode. This command is used to restart authentication after changing the DH-CHAP group, hash type, or shared secret between a pair of switches.

---

### ATTENTION

This command may bring down E\_Ports if the DH-CHAP shared secrets are not installed correctly.

---

1. Log in to the switch using an account assigned to the admin role.
2. Enter the **authUtil --authinit** command.

#### Example for specific ports on the switch

```
switch:admin> authutil --authinit 2,3,4
```

#### Example for all E\_Ports on the switch

```
switch:admin> authutil --authinit allE
```

#### Example for enterprise-class platforms using the slot/port format

```
switch:admin> authutil --authinit 1/1, 1/2
```

## Device authentication policy

Device authentication policy can also be categorized as an F\_Port, node port, or an HBA authentication policy. Fabric-wide distribution of the device authentication policy is not supported because the device authentication requires manual interaction in setting the HBA shared secrets and switch shared secrets, and most of the HBAs do not support the defined DH groups for use in the DH-CHAP protocol.

By default the switch is in the OFF state, which means the switch clears the security bit in the FLOGI (fabric login). The **authUtil** command provides an option to change the device policy mode to select PASSIVE policy, which means the switch responds to authentication from any device and does not initiate authentication to devices. When the policy is set to ON, the switch expects a FLOGI with the FC-SP bit set. If not, the switch rejects the FLOGI with reason LS\_LOGICAL\_ERROR (0x03), explanation "Authentication Required"(0x48), and disables the port. Regardless of the policy, the F\_Port is disabled if the DH-CHAP protocol fails to authenticate. If the HBA sets the FC-SP bit during FLOGI and the switch sends a FLOGI accept with the FC-SP bit set, then the switch expects the HBA to start the AUTH\_NEGOTIATE. From this point on until the AUTH\_NEGOTIATE is completed, all ELS and CT frames, except the AUTH\_NEGOTIATE ELS frame, are blocked by the switch. During this time, the Fibre Channel driver rejects all other ELS frames. The F\_Port does not form until the AUTH\_NEGOTIATE is completed. It is the HBA's responsibility to send an Authentication Negotiation ELS frame after receiving the FLOGI accept frame with the FC-SP bit set.

**Virtual Fabric considerations:** Because the device authentication policy has switch and logical switch-based parameters, each logical switch is set when Virtual Fabrics is enabled. Authentication is enforced based on each logical switch's policy settings.

### *Configuring device authentication*

1. Connect to the switch and log in using an account assigned to the admin role.
2. Enter the **authUtil** command to set the device policy mode.

**Example of setting the Device policy to passive mode:**

```
switch:admin> authutil --policy -dev passive
Warning: Activating the authentication policy requires
DH-CHAP secrets on both switch and device. Otherwise,
the F-port will be disabled during next F-port
bring-up.
ARE YOU SURE (yes, y, no, n): [no] y
Device authentication is set to PASSIVE
```

## AUTH policy restrictions

All fabric element authentication configurations are performed on a local switch basis.

Device authentication policy supports devices that are connected to the switch in point-to-point manner and is visible to the entire fabric. The following are not supported:

- Public loop devices
- Single private devices
- Private loop devices
- Mixed public and private devices in loop
- NPIV devices

- FICON channels
- Configupload and download will not be supported for the following AUTH attributes: auth type, hash type, group type.

### *Supported HBAs*

The following HBAs support authentication:

- Emulex LP11000 (Tested with Storport Miniport v2.0 windows driver)
- Qlogic QLA2300 (Tested with Solaris v5.04 driver)
- Brocade Fibre Channel HBA models 415, 425, 815 and 825

## Authentication protocols

Use the **authUtil** command to perform the following tasks:

- Display the current authentication parameters.
- Select the authentication protocol used between switches.
- Select the DH (Diffie-Hellman) group for a switch.

Run the **authUtil** command on the switch you want to view or change. Below are the different options to specify which DH group you want to use.

- 00 – DH Null option
- 01 – 1024 bit key
- 02 – 1280 bit key
- 03 - 1536 bit key
- 04 – 2048 bit key

### *Viewing the current authentication parameter settings for a switch*

1. Log in to the switch using an account assigned to the admin role.
2. Enter the **authUtil --show**.

**Example of output from the authUtil --show command**

```
AUTH TYPE          HASH TYPE          GROUP TYPE
-----
fcap,dhchap       sha1,md5           0, 1, 2, 3, 4

Switch Authentication Policy: PASSIVE
Device Authentication Policy: OFF
```

### *Setting the authentication protocol*

1. Log in to the switch using an account assigned to the admin role.
2. Enter the **authUtil --set -a** command specifying **fcap**, **dhchap**, or **all**.

**Example of setting the DH-CHAP authentication protocol**

```
switch:admin> authutil --set -a dhchap
Authentication is set to dhchap.
```

When using DH-CHAP, make sure that you configure the switches at both ends of a link.

---

**NOTE**

If you set the authentication protocol to DH-CHAP or FCAP, have not configured shared secrets or certificates, and authentication is checked (for example, you enable the switch), then switch authentication fails.

---

## Secret key pairs for DH-CHAP

When you configure the switches at both ends of a link to use DH-CHAP for authentication, you must also define a *secret key pair*—one for each end of the link. Use the **secAuthSecret** command to perform the following tasks:

- View the WWN of switches with a *secret key pair*.
- Set the *secret key pair* for switches.
- Remove the *secret key pair* for one or more switches.

Note the following characteristics of a *secret key pair*:

- The *secret key pair* must be set up locally on every switch. The *secret key pair* is not distributed fabric-wide.
- If a *secret key pair* is not set up for a link, authentication fails. The “Authentication Failed” (reason code 05h) error will be reported and logged.
- The minimum length of a shared secret is 8 bytes and the maximum length is 40 bytes.

---

**NOTE**

When setting a *secret key pair*, note that you are entering the shared secrets in plain text. Use a secure channel (for example, SSH or the serial console) to connect to the switch on which you are setting the secrets.

---

### *Viewing the list of secret key pairs in the current switch database*

1. Log in to the switch using an account assigned to the admin role.
2. Enter the **secAuthSecret --show** command.

The output displays the WWN, domain ID, and name (if known) of the switches with defined shared secrets:

WWN	DId	Name
-----		
10:00:00:60:69:80:07:52		Unknown
10:00:00:60:69:80:07:5c	1	switchA

### *Setting a secret key pair*

1. Log in to the switch using an account assigned to the admin role.
2. Enter the **secAuthSecret --set** command.

The command enters interactive mode. The command returns a description of itself and needed input; then it loops through a sequence of switch specification, peer secret entry, and local secret entry.

To exit the loop, press **Enter** for the switch name; then type **y**.

### Example of setting a secret key pair

```
switchA:admin> secauthsecret --set
```

This command is used to set up secret keys for the DH-CHAP authentication. The minimum length of a secret key is 8 characters and maximum 40 characters. Setting up secret keys does not initiate DH-CHAP authentication. If switch is configured to do DH-CHAP, it is performed whenever a port or a switch is enabled.

Warning: Please use a secure channel for setting secrets. Using an insecure channel is not safe and may compromise secrets.

Following inputs should be specified for each entry.

1. WWN for which secret is being set up.
2. Peer secret: The secret of the peer that authenticates to peer.
3. Local secret: The local secret that authenticates peer.

Press Enter to start setting up shared secrets > **<cr>**

Enter WWN, Domain, or switch name (Leave blank when done):  
**10:20:30:40:50:60:70:80**

Enter peer secret: **<hidden>**  
Re-enter peer secret: **<hidden>**  
Enter local secret: **<hidden>**  
Re-enter local secret: **<hidden>**

Enter WWN, Domain, or switch name (Leave blank when done):  
**10:20:30:40:50:60:70:81**

Enter peer secret: **<hidden>**  
Re-enter peer secret: **<hidden>**  
Enter local secret: **<hidden>**  
Re-enter local secret: **<hidden>**

Enter WWN, Domain, or switch name (Leave blank when done): **<cr>**  
Are you done? (yes, y, no, n): [no] **y**

Saving data to key store.. Done.

3. Disable and enable the ports on a peer switch using the **portDisable** and **portEnable** commands.

## FCAP configuration overview

You can configure the switch to use either Brocade or a third-party certificates for authentication with the peer switch. By default, Brocade certificates are used for authentication.

To perform authentication with FCAP protocol with certificates issued from third party, the user has to perform following steps:

1. Choose a certificate authority (CA).
2. Generate a public, private key, passphrase and a CSR on each switch.
3. Store the CSR from each switch on a file server.
4. Obtain the certificates from the CA.

You can request a certificate from a CA through a Web browser. After you request a certificate, the CA either sends certificate files by e-mail (public) or gives access to them on a remote host (private). Typically, the CA provides the certificate files listed in [Table 31](#).

---

**ATTENTION**

Only the .pem file is supported for FCAP authentication.

---

**TABLE 31** FCAP certificate files

Certificate file	Description
<i>nameCA.pem</i>	The CA certificate. It must be installed on the remote and local switch to verify the validity of the switch certificate or switch validation fails.
<i>name.pem</i>	The switch certificate.

- On each switch, install the CA certificate before installing switch certificate.
- After the CA certificate is installed, install the switch certificate on each switch.
- Update the switch database for peer switches to use third-party certificates.
- Use the newly installed certificates by starting the authentication process.

### *Generating the key and CSR for FCAP*

The public/private key and CSR has to be generated for the local and remote switches that will participate in the authentication. In FCAP, one command is used to generate the public/private key the CSR, and the passphrase.

- Log in to the switch using an account assigned to the admin role.
- Enter the **secCertUtil generate -fcapall -keysize** command on the local switch.

```
switch:admin> seccertutil generate -fcapall -keysize 1024
WARNING!!!
```

```
About to create FCAP:
ARE YOU SURE (yes, y, no, n): [no] y
Installing Private Key and Csr...
Switch key pair and CSR generated...
```

- Repeat [step 2](#) on the remote switch.

### *Exporting the CSR for FCAP*

You will need to export the CSR file created in “[Generating the key and CSR for FCAP](#)” section and send to a Certificate Authority (CA). The CA will in turn provide two files as outlined in “[FCAP configuration overview](#)” on page 150.

- Log in to the switch using an account assigned to the admin role.
- Enter the **secCertUtil export -fcapswcert** command.

```
switch:admin> seccertutil export -fcapswcert
Select protocol [ftp or scp]: scp
Enter IP address: 10.1.2.3
Enter remote directory: /myHome/jdoe/OPENSSL
Enter Login Name: jdoe
```

```
jdooe@10.1.2.3's password: <hidden text>
Success: exported FCAP CA certificate
```

### *Import CA for FCAP*

Once you receive the files back from the Certificate Authority, you will need to install or import them onto the local and remote switches.

1. Log in to the switch using an account assigned to the admin role.
2. Enter the `secCertUtil import -fcapswcert` command and verify the CA certificates are consistent on both local and remote switches.

```
switch:admin> seccertutil import -fcapcacert
Select protocol [ftp or scp]: scp
Enter IP address: 10.1.2.3
Enter remote directory: /myHome/jdooe/OPENSsl
Enter certificate name (must have a ".pem" suffix): CACert.pem
Enter Login Name: jdooe
jdooe@10.1.2.3's password: <hidden text>
Success: imported certificate [CACert.pem].
```

### *Importing the FCAP switch certificate*

---

#### ATTENTION

The CA certificates must be installed prior to installing the switch certificate.

---

1. Log in to the switch using an account assigned to the admin role.
2. Enter the `secCertUtil import -fcapswcert` command.

```
switch:admin> seccertutil import -fcapswcert
Select protocol [ftp or scp]: scp
Enter IP address: 10.1.2.3
Enter remote directory: /myHome/jdooe/OPENSsl
Enter certificate name (must have ".crt" or ".cer" ".pem" or ".psk"
suffix): 01.pem
Enter Login Name: jdooe
jdooe@10.1.2.3's password: <hidden text>
Success: imported certificate [01.pem].
```

### *Updating the switch database for FCAP authentication*

1. Log in to the switch using an account assigned to the admin role.
2. Enter the `secAuthCertificate --set - wwn <WWN> -usercert thirdparty` command to update the switch database for peer switches.

### *Starting FCAP authentication*

1. Log in to the switch using an account assigned to the admin role.
2. Enter the `authUtil --authinit` command to start the authentication using the newly imported certificates.
3. Enter the `authUtil -policy -sw` command and select **active** or **on**, the default is passive. This makes the changes permanent and forces the switch to request authentication.



## Fabric-wide distribution of the Auth policy

The AUTH policy can be manually distributed to the fabric by command; there is no support for automatic distribution. To distribute the AUTH policy, see [“Distributing the local ACL policies”](#) on page 160 for instructions.

Local Switch configuration parameters are needed to control whether a switch accepts or rejects distributions of the AUTH policy using the distribute command and whether the switch may initiate distribution of the policy. To set the local switch configuration parameter, refer to [“Policy database distribution”](#) on page 158.

## IP Filter policy

The IP Filter policy is a set of rules applied to the IP management interfaces as a packet filtering firewall. The firewall permits or denies the traffic to go through the IP management interfaces according to the policy rules.

Fabric OS supports multiple IP Filter policies to be defined at the same time. Each IP Filter policy is identified by a name and has an associated type. Two IP Filter policy types, IPv4 and IPv6, exist to provide separate packet filtering for IPv4 and IPv6. It is not allowed to specify an IPv6 address in the IPv4 filter, or specify an IPv4 address in the IPv6 filter. There can be up to six different IP Filter policies defined for both types. Only one IP Filter policy for each IP type can be activated on the affected management IP interfaces.

Audit messages will be generated for any changes to the IP Filter policies.

The rules in the IP Filter policy are examined one at a time until the end of the list of rules. For performance reasons, the most important rules must be specified at the top.

On a chassis system, changes to persistent IP Filter policies are automatically synchronized to the standby CP when the changes are saved persistently on the active CP. The standby CP will enforce the filter policies to its management interface after policies are synchronized with the active CP.

**Virtual Fabric considerations:** Each logical switch cannot have its own different IP Filter policies. IP Filter policies are treated as a chassis-wide configuration and are common for all the logical switches in the chassis.

## Creating an IP Filter policy

You can create an IP Filter policy specifying any name and using type IPv4 or IPv6. The policy created is stored in a temporary buffer, and is lost if the current command session logs out. The policy name is a unique string composed of a maximum of 20 alpha, numeric, and underscore characters. The names *default\_ipv4* and *default\_ipv6* are reserved for default IP filter policies. The policy name is case-insensitive and always stored as lowercase. The policy type identifies the policy as an IPv4 or IPv6 filter. There can be a maximum of six IP Filter policies created for both types.

1. Log in to the switch using an account assigned to the admin role.
2. Enter in the `ipFilter--create` command.

## Cloning an IP Filter policy

You can create an IP Filter policy as an exact copy of an existing policy. The policy created is stored in a temporary buffer and has the same type and rules as the existing defined or active policy.

1. Log in to the switch using an account assigned to the admin role.
2. Enter the **ipFilter --clone** command.

## Displaying an IP Filter policy

You can display the IP Filter policy content for the specified policy name, or all IP Filter policies if a policy name is not specified.

For each IP Filter policy, the policy name, type, persistent state and policy rules are displayed. The policy rules are listed by the rule number in ascending order. There is no pagination stop for multiple screens of information. Pipe the output to the **|more** command to achieve this.

If a temporary buffer exists for an IP Filter policy, the **--show** subcommand displays the content in the temporary buffer, with the persistent state set to no.

1. Log in to the switch using an account assigned to the admin role.
2. Enter the **ipFilter --show** command.

## Saving an IP Filter policy

You can save one or all IP Filter policies persistently in the defined configuration. The policy name is optional for this subcommand. If the policy name is given, the IP Filter policy in the temporary buffer is saved; if the policy name is not given, all IP Filter policies in the temporary buffer are saved. Only the CLI session that owns the updated temporary buffer may run this command. Modification to an active policy cannot be saved without being applied. Hence, the **--save** subcommand is blocked for the active policies. Use **--activate** instead.

1. Log in to the switch using an account assigned to the admin role.
2. Enter the **ipFilter --save** command.

## Activating an IP Filter policy

IP Filter policies are not enforced until they are activated. Only one IP Filter policy per IPv4 and IPv6 type can be active. If there is a temporary buffer for the policy, the policy is saved to the defined configuration and activated at the same time. If there is no temporary buffer for the policy, the policy existing in the defined configuration becomes active. The activated policy continues to remain in the defined configuration. The policy to be activated replaces the existing active policy of the same type. Activating the default IP Filter policies returns the IP management interface to its default state. An IP Filter policy without any rule cannot be activated. This subcommand prompts for a user confirmation before proceeding.

1. Log in to the switch using an account assigned to the admin role.
2. Enter the **ipFilter --activate** command.

## Deleting an IP Filter policy

You can delete a specified IP Filter policy. Deleting an IP Filter policy removes it from the temporary buffer. To permanently delete the policy from the persistent database, run **ipfilter --save**. An active IP Filter policy cannot be deleted.

1. Log in to the switch using an account assigned to the admin role.
2. Enter the **ipFilter --delete** command.
3. To permanently delete the policy, enter the **ipfilter --save** command.

## IP Filter policy rules

An IP Filter policy consists of a set of rules. Each rule has an index number identifying the rule. There can be a maximum of 256 rules within an IP Filter policy.

Each rule contains the following elements:

- **Source Address:** A source IP address or a group prefix.
- **Destination Port:** The destination port number or name, such as: Telnet, SSH, HTTP, HTTPS.
- **Protocol:** The protocol type. Supported types are TCP or UDP.
- **Action:** The filtering action taken by this rule, either Permit or Deny.

For an IPv4 filter policy, the source address has to be a 32-bit IPv4 address in dot decimal notation. The group prefix has to be a CIDR block prefix representation. For example, 208.130.32.0/24 represents a 24-bit IPv4 prefix starting from the most significant bit. The special prefix 0.0.0.0/0 matches any IPv4 address. In addition, the keyword *any* is supported to represent any IPv4 address.

For an IPv6 filter policy, the source address has to be a 128-bit IPv6 address, in a format acceptable in RFC 3513. The group prefix has to be a CIDR block prefix representation. For example, 12AB:0:0:CD30::/64 represents a 64-bit IPv6 prefix starting from the most significant bit. In addition, the keyword *any* is supported to represent any IPv6 address.

For the destination port, a single port number or a port number range can be specified. According to IANA (<http://www.iana.org>), ports 0 to 1023 are well-known port numbers, ports 1024 to 49151 are registered port numbers, and ports 49152 to 65535 are dynamic or private port numbers. Well-known and registered ports are normally used by servers to accept connections, while dynamic port numbers are used by clients.

For an IP Filter policy rule, you can only select port numbers in either the well-known or the registered port number range, between 0 and 49151, inclusive. This means that you have the ability to control how to expose the management services hosted on a switch, but not the ability to affect the management traffic that is initiated from a switch. A valid port number range is represented by a dash, for example 7-30. Alternatively, service names can also be used instead of port number. [Table 32](#) lists the supported service names and their corresponding port number.

**TABLE 32** Supported services

Service name	Port number
http	443
rpcd	897
securerpcd	898

**TABLE 32** Supported services (Continued)

Service name	Port number
snmp	161
ssh	22
sunrpc	111
telnet	23
www	80

TCP and UDP protocols are valid selections. Fabric OS v6.2.0 and later does not support configuration to filter other protocols. Implicitly, ICMP type 0 and type 8 packets are always allowed to support ICMP echo request and reply on commands like ping and traceroute. For the action, only “permit” and “deny” are valid.

For every IP Filter policy, the two rules listed in [Table 33](#) are always assumed to be appended implicitly to the end of the policy. This ensures that TCP and UDP traffic to dynamic port ranges is allowed, so that management IP traffic initiated from a switch, such as syslog, radius and ftp, is not affected.

**TABLE 33** Implicit IP Filter rules

Source address	Destination port	Protocol	Action
Any	1024-65535	TCP	Permit
Any	1024-65535	UDP	Permit

A switch with Fabric OS v6.2.0 or later will have a default IP Filter policy for IPv4 and IPv6. The default IP Filter policy cannot be deleted or changed. When an alternative IP Filter policy is activated, the default IP Filter policy becomes deactivated. [Table 34](#) lists the rules of the default IP Filter policy.

**TABLE 34** Default IP policy rules

Rule number	Source address	Destination port	Protocol	Action
1	Any	22	TCP	Permit
2	Any	23	TCP	Permit
3	Any	897	TCP	Permit
4	Any	898	TCP	Permit
5	Any	111	TCP	Permit
6	Any	80	TCP	Permit
7	Any	443	TCP	Permit
9	Any	161	UDP	Permit
10	Any	111	UDP	Permit
11	Any	123	UDP	Permit
12	Any	600-1023	UDP	Permit

## IP Filter policy enforcement

An active IP Filter policy is a filter applied to the IP packets through the management interface. IPv4 management traffic passes through the active IPv4 filter policy, and IPv6 management traffic passes through the active IPv6 filter policy. The IP Filter policy applies to the incoming (ingress) management traffic only. When a packet arrives, it is compared against each rule, starting from the first rule. If a match is found for the source address, destination port, and protocol, the corresponding action for this rule is taken, and the subsequent rules in this policy are ignored. If there is no match, then it is compared to the next rule in the policy. This process continues until the incoming packet is compared to all rules in the active policy.

If none of the rules in the policy matches the incoming packet, the two implicit rules are matched to the incoming packet. If the rules still do not match the packet, the default action, which is to deny, is taken.

When the IPv4 or IPv6 address for the management interface of a switch is changed through the **ipAddrSet** command or manageability tools, the active IP Filter policies automatically become enforced on the management IP interface with the changed IP address.

---

### NOTE

If a switch is part of a LAN behind a Network Address Translation (NAT) server, depending on the NAT server configuration, the source address in an IP Filter rule may have to be the NAT server address.

---

## Adding a rule to an IP Filter policy

There can be a maximum of 256 rules created for an IP Filter policy. The change to the specified IP Filter policy is not saved to the persistent configuration until a save or activate subcommand is run.

1. Log in to the switch using an account assigned to the admin role.
2. Enter the **ipFilter --addrule** command.

## Deleting a rule to an IP Filter policy

Deleting a rule in the specified IP Filter policy causes the rules following the deleted rule to shift up in rule order. The change to the specified IP Filter policy is not saved to persistent configuration until a save or activate subcommand is run.

1. Log in to the switch using an account assigned to the admin role.
2. Enter the **ipFilter --delrule** command:

## Aborting an IP Filter transaction

A transaction is associated with a command line or manageability session. It is opened implicitly when the **--create**, **--addrule**, **--delrule**, **--clone**, and **--delete** subcommands are run. The **--transabort**, **--save**, or **--activate** subcommands explicitly end the transaction owned by the current command line or manageability session. If a transaction is not ended, other command line or manageability sessions are blocked on the subcommands that would open a new transaction.

1. Log in to the switch using an account assigned to the admin role.
2. Enter the **ipFilter --transabort** command.

## IP Filter policy distribution

The IP Filter policy is manually distributed by command. The distribution includes both active and defined IP Filter policies. All policies are combined as a single entity to be distributed and cannot be selectively distributed. However, you may choose the time at which to implement the policy for optimization purposes. If a distribution includes an active IP Filter policy, the receiving switches activate the same IP Filter policy automatically. When a switch receives IP Filter policies, all uncommitted changes left in its local transaction buffer are lost, and the transaction is aborted.

The IPFilter policy can be manually distributed to the fabric by command; there is no support for automatic distribution. To distribute the IPFilter policy, see [“Distributing the local ACL policies”](#) on page 160 for instructions.

Switches with Fabric OS v6.2.0 or later have the ability to accept or deny IP Filter policy distribution, through the commands `fddCfg --localaccept` or `fddCfg --localreject`. See [“Policy database distribution”](#) on page 158 for more information on distributing the IP Filter policy.

**Virtual Fabric considerations:** To distribute the IPFilter policy in a logical fabric, use the `chassisDistribute` command.

## Policy database distribution

Fabric OS lets you manage and enforce the ACL policy database on either a per-switch or fabric-wide basis. The local switch distribution setting and the fabric-wide consistency policy affect the switch ACL policy database and related distribution behavior.

The ACL policy database is managed as follows:

- **Switch database distribution setting** — Controls whether or not the switch accepts or rejects databases distributed from other switches in the fabric. The `distribute` command sends the database from one switch to another, overwriting the target switch database with the distributed one. To send or receive a database the setting must be `accept`. For configuration instructions, see [“Database distribution settings”](#) on page 159.

Virtual Fabric considerations: FCS, DCC, SCC, and AUTH databases can be distributed using the `-distribute` command, but the PWD and IPFILTER databases are blocked from distribution.

- **Manually distribute an ACL policy database** — Run the `distribute` command to push the local database of the specified policy type to target switches. [“ACL policy distribution to other switches”](#) on page 160.
- **Fabric-wide consistency policy** — Use to ensure that switches in the fabric enforce the same policies. Set a strict or tolerant fabric-wide consistency policy for each ACL policy type to automatically distribute that database when a policy change is activated. If a fabric-wide consistency policy is not set, then the policies are managed on a per switch basis. For configuration instructions, see [“Fabric-wide enforcement”](#) on page 160.

**Virtual Fabric considerations:** Fabric-wide consistency policies are configured on a per logical switch-basis and are applied to the fabrics connected to the logical switches. Automatic policy distribution behavior for DCC, SCC and FCS is the same as that of pre-v6.2.0 releases and are configured on a per logical switch basis.

[Table 35](#) on page 159 explains how the local database distribution settings and the fabric-wide consistency policy affect the local database when the switch is the target of a distribution command.

**TABLE 35** Interaction between fabric-wide consistency policy and distribution settings

Distribution setting	Fabric-wide consistency policy		
	Absent (default)	Tolerant	Strict
Reject	Database is protected, it cannot be overwritten. May not match other databases in the fabric.	Invalid configuration. <sup>1</sup>	Invalid configuration. <sup>1</sup>
Accept (default)	Database is not protected, the database can be overwritten. If the switch initiating a distribute command has a strict or tolerant fabric-wide consistency policy, the fabric-wide policy is also overwritten. May not match other databases in the fabric.	Database is not protected. Automatically distributes activated changes to other v6.2.0 or later switches in the fabric. May not match other databases in the fabric.	Database is not protected. Automatically distributes activated changes to all switches in the fabric. Fabric can only contain switches running Fabric OS v6.2.0 or later. Active database is the same for all switches in the fabric.

1. An error is returned indicating that the distribution setting must be accept before you can set the fabric-wide consistency policy.

## Database distribution settings

The distribution settings control whether a switch accepts or rejects distributions of databases from other switches and whether the switch may initiate a distribution. Configure the distribution setting to reject when maintaining the database on a per-switch basis.

Table 36 lists the databases supported in Fabric OS v6.2.0 and later switches.

**TABLE 36** Supported policy databases

Database type	Database identifier (ID)
Authentication policy database	AUTH
DCC policy database	DCC
FCS policy database	FCS
IP Filter policy database	IPFILTER
Password database	PWD
SCC policy database	SCC

Use the **chassisDistribute** command to distribute IP filter policies. To distribute other security policies, use the **distribute** command.

### *Displaying the database distribution settings*

1. Connect to the switch and log in using an account assigned to the admin role.
2. Enter the **fdccfg --showall** command.

**Example** shows the database distribution settings

```
switch:admin> fdccfg --showall
Local Switch Configuration for all Databases:-
```

```
      DATABASE - Accept/Reject
-----
      SCC - accept
      DCC - accept
      PWD - accept
      FCS - accept
      AUTH - accept
      IPFILTER - accept

Fabric Wide Consistency Policy:- ""
```

### *Enabling local switch protection*

1. Connect to the switch and log in using an account assigned to the admin role.
2. Enter the **fddCfg --localreject** command.

### *Disabling local switch protection*

1. Connect to the switch and log in using an account assigned to the admin role.
2. Enter the **fddCfg --localaccept** command.

## ACL policy distribution to other switches

This section explains how to manually distribute local ACL policy databases. The **distribute** command has the following dependencies:

- All target switches must be running Fabric OS v6.2.0 or later.
- All target switches must accept the database distribution (see [“Database distribution settings”](#) on page 159).
- The fabric must have a tolerant or no (absent) fabric-wide consistency policy (see [“Fabric-wide enforcement”](#) on page 160).

If the fabric-wide consistency policy for a database is strict, the database cannot be manually distributed. When you set a strict fabric-wide consistency policy for a database, the distribution mechanism is automatically invoked whenever the database changes.

- The local distribution setting must be accepted. To be able to initiate the distribute command, set the local distribution to accept.

### *Distributing the local ACL policies*

1. Connect to the switch and log in using an account assigned to the admin role.
2. Enter the **distribute -p** command.

## Fabric-wide enforcement

The fabric-wide consistency policy enforcement setting determines the distribution behavior when changes to a policy are activated. Using the tolerant or strict fabric-wide consistency policy ensures that changes to local ACL policy databases are automatically distributed to other switches in the fabric.



**NOTE**

To completely remove all policies from a fabric enter the **fddCfg --fabwideset ""** command.

When you set the fabric-wide consistency policy using the **fddCfg** command with the **--fabwideset <database\_id>** option, both the fabric-wide consistency policy and specified database are distributed to the fabric. The active policies of the specified databases overwrite the corresponding active and defined policies on the target switches.

Policy changes that are saved but not activated are stored locally until a policy database change is activated. Activating a policy automatically distributes the Active policy set for that policy type (SCC, DCC, or both) to the other switches in the fabric.

**NOTE**

FC routers cannot join a fabric with a strict fabric-wide consistency policy. FC routers do not support the fabric-wide consistency policies.

[Table 37](#) describes the fabric-wide consistency settings.

**TABLE 37 Fabric-wide consistency policy settings**

Setting	Value	When a policy is activated
Absent	null	Database is not automatically distributed to other switches in the fabric.
Tolerant	<i>database_id</i>	All updated and new policies of the type specified (SCC, DCC, or both) are distributed to all Fabric v6.2.0 and later switches in the fabric.
Strict	<i>database_id</i> :S	All updated and new policies of the type specified (SCC, DCC, or both) are distributed to all switches in the fabric.

### *Displaying the fabric-wide consistency policy*

1. Connect to the switch and log in using an account assigned to the admin role.
2. Enter the **fddCfg --showall** command.

**Example** shows policies for a fabric where no consistency policy is defined.

```
switch:admin> fddcfg --showall
Local Switch Configuration for all Databases:-
  DATABASE - Accept/Reject
-----
          SCC - accept
          DCC - accept
          PWD - accept
          FCS - accept
          AUTH - accept
          IPFILTER - accept

Fabric Wide Consistency Policy:- ""
```

### *Setting the fabric-wide consistency policy*

1. Connect to the switch and log in using an account assigned to the admin role.
2. Enter the **fddCfg --fabwideset** command.

**Example** shows how to set a strict SCC and tolerant DCC fabric-wide consistency policy.

```
switch:admin> fddcfg --fabwideset "SCC:S;DCC"
```

```
switch:admin> fddcfg --showall
Local Switch Configuration for all Databases:-
  DATABASE - Accept/Reject
-----
      SCC -      accept
      DCC -      accept
      PWD -      accept
      FCS -      accept
      AUTH -     accept
      IPFILTER - accept

Fabric Wide Consistency Policy:- "SCC:S;DCC"
```

## Notes on joining a switch to the fabric

When a switch is joined to a fabric with a tolerant SCC or DCC fabric-wide consistency policy, the joining switch must have a matching tolerant SCC or DCC fabric-wide consistency policy. If the tolerant SCC or DCC fabric-wide consistency policies do not match, the switch can join the fabric, but an error message flags the mismatch. If the tolerant SCC and DCC fabric-wide consistency policies match, the corresponding SCC and DCC ACL policies are compared.

The enforcement of fabric-wide consistency policy involves comparison of only the Active policy set. If the ACL policies match, the switch joins the fabric successfully. If the ACL policies are absent on the switch or on the fabric, the switch joins the fabric successfully, and the ACL policies are copied automatically from where they exist to where they are absent. The Active policies set where they exist and overwrite the Active and Defined policies where they are absent. If the ACL policies do not match, the switch can join the fabric, but an error message flags the mismatch.

Under both conflicting conditions, **secPolicyActivate** is blocked in the merged fabric. Use the **fddCfg --fabwideset** command to resolve the fabric-wide consistency policy conflicts. Use the **distribute** command to explicitly resolve conflicting ACL policies.

When a switch is joined to a fabric with a strict SCC or DCC fabric-wide consistency policy, the joining switch must have a matching fabric-wide consistency policy. If the strict SCC or DCC fabric-wide consistency policies do not match, the switch cannot join the fabric and the neighboring E\_Ports are disabled. If the strict SCC and DCC fabric-wide consistency policies match, the corresponding SCC and DCC ACL policies are compared.

The enforcement of fabric-wide consistency policy involves comparison of only the Active policy set. If the ACL policies match, the switch joins the fabric successfully. If the ACL policies are absent either on the switch or on the fabric, the switch joins the fabric successfully, and the ACL policies are copied automatically from where they are present to where they are absent. The Active policy set where it is present overwrites the Active and Defined policy set where it is absent. If the ACL policies do not match, the switch cannot join the fabric and the neighboring E\_Ports are disabled.

Use the **fddCfg --fabwideset** command on either this switch or the fabric to set a matching strict SCC or DCC fabric-wide consistency policy. Use ACL policy commands to delete the conflicting ACL policy from one side to resolve ACL policy conflict. If neither the fabric nor the joining switch is configured with a fabric-wide consistency policy, there are no ACL merge checks required.

The descriptions above also apply to joining two fabrics. In this context, the joining switch becomes a joining fabric.

### *Matching fabric-wide consistency policies*

This section describes the interaction between the databases with active SCC and DCC policies and combinations of fabric-wide consistency policy settings when fabrics are merged.

For example: Fabric A with SCC:S;DCC (strict SCC and tolerant DCC) joins Fabric B with SCC:S;DCC (strict SCC and tolerant DCC), the fabrics can merge as long as the SCC policies match, including the order SCC:S;DCC and if both are set to strict.

[Table 38](#) describes the impact of merging fabrics with the same fabric-wide consistency policy that have SCC, DCC, or both policies.

**TABLE 38** Merging fabrics with matching fabric-wide consistency policies

Fabric-wide consistency policy	Fabric A ACL policies	Fabric B ACL policies	Merge results	Database copied
None	None	None	Succeeds	No ACL policies copied.
	None	SCC/DCC	Succeeds	No ACL policies copied.
Tolerant	None	None	Succeeds	No ACL policies copied.
	None	SCC/DCC	Succeeds	ACL policies are copied from B to A.
	SCC/DCC	SCC/DCC	Succeeds	If A and B policies do not match, a warning displays and policy commands are disabled <sup>1</sup> .
Strict	None	None	Succeeds	No ACL policies copied.
	None	SCC/DCC	Succeeds	ACL policies are copied from B to A.
	Matching SCC/DCC	Matching SCC/DCC	Succeeds	No ACL policies copied.
	Different SCC/DCC policies	Different SCC/DCC policies	Fails	Ports are disabled.

1. To resolve the policy conflict, manually distribute the database you want to use to the switch with the mismatched database. Until the conflict is resolved, commands such as **fdDCfg --fabwideset** and **secPolicyActivate** are blocked.

### *Non-matching fabric-wide consistency policies*

You may encounter one of the following two scenarios described in [Table 39](#) and [Table 40](#) where you are merging a fabric with a strict policy to a fabric with an absent, tolerant, or non-matching strict policy and the merge fails and the ports are disabled.

[Table 39](#) on page 164 shows merges that are not supported.

**TABLE 39** Examples of strict fabric merges

Fabric-wide consistency policy setting	Fabric A		Expected behavior
	Fabric A	Fabric B	
Strict/Tolerant	SCC:S;DCC:S	SCC;DCC:S	Ports connecting switches are disabled.
	SCC;DCC:S	SCC:S;DCC	
Strict/Absent	SCC:S;DCC:S		
	SCC:S		
	DCC:S		
Strict/Strict	SCC:S	DCC:S	

Table 40 has a matrix of merging fabrics with tolerant and absent policies.

**TABLE 40** Fabric merges with tolerant/absent combinations

Fabric-wide consistency policy setting	Fabric A		Expected behavior
	Fabric A	Fabric B	
Tolerant/Absent	SCC;DCC		Error message logged. Run <code>fddCfg --fabwideset "&lt;policy_ID&gt;"</code> from any switch with the desired configuration to fix the conflict. The <code>secPolicyActivate</code> command is blocked until conflict is resolved.
	DCC		
	SCC;DCC	SCC	
	DCC	SCC	

## Management interface security

You can secure an Ethernet management interface between two Brocade switches or enterprise-class platforms by implementing IPsec and IKE policies to create a tunnel that protects traffic flows. The tunnel has at each end a Brocade switch or enterprise-class platform. There may be routers, gateways, and firewalls in between the two ends.

### ATTENTION

Enabling secure IPsec tunnels does not provide IPsec protection for traffic flows on the external management interfaces of intelligent blades in a chassis, nor does it support protection of traffic flows on FCIP interfaces.

Internet Protocol security (IPsec) is a framework of open standards that ensures private and secure communications over Internet Protocol (IP) networks through the use of cryptographic security services. The goal of IPsec is to provide the following capabilities:

- **Authentication** – Ensures that the sending and receiving end-users and devices are known and trusted by one another.
- **Data Integrity** – Confirms that the data received was in fact the data transmitted.
- **Data Confidentiality** – Protects the user data being transmitted, such as utilizing encryption to avoid sending data in clear text.

- **Replay Protection** — Prevents replay attack, a type of denial of service (DoS) attack where an attacker intercepts a series of packets and resends them to cause the recipient to waste CPU cycles processing them.
- **Automated Key Management**—Automates the process, as well as manages the periodic exchange and generation of new keys.

Using the `ipsecConfig` command, you must configure multiple security policies for traffic flows on the Ethernet management interfaces based on IPv4 or IPv6 addresses, a range of IPv4 or IPv6 addresses, the type of application, port numbers, and port types used (UDP/TCP). You must specify the transforms and processing choices for the traffic flow (drop, protect or bypass). Also, you must select and configure the key management protocol using an automatic or manual key.

For more information on IPv4 and IPv6 addressing, refer to [Chapter 2, “Performing Basic Configuration Tasks”](#).

## Configuration examples

Below are several examples of various configurations you can use to implement an IPsec tunnel between two devices. You can configure other scenarios as nested combinations of these configurations.

### *Endpoint-to-Endpoint Transport or Tunnel*

In this scenario, both endpoints of the IP connection implement IPsec, as required of hosts in RFC4301. The transport mode is commonly used with no inner IP header. If there is an inner IP header, the inner addresses will be the same as the outer addresses. A single pair of addresses will be negotiated for packets protected by this SA.

It is possible in this scenario that one or both of the protected endpoints will be behind a network address translation (NAT) node, in which case the tunneled packets will have to be UDP-encapsulated so that port numbers in the UDP headers can be used to identify individual endpoints behind the NAT.



**FIGURE 17** Protected endpoints configuration

A possible drawback of end-to-end security is that various applications that require the ability to inspect or modify a transient packet will fail when end-to-end confidentiality is employed. Various QoS solutions, traffic shaping, and firewalling applications will be unable to determine what type of packet is being transmitted and will be unable to make the decisions that they are supposed to make.

### Gateway-to-Gateway Tunnel

In this scenario, neither endpoint of the IP connection implements IPsec, but the network nodes between them protect traffic for part of the way. Protection is transparent to the endpoints, and depends on ordinary routing to send packets through the tunnel endpoints for processing. Each endpoint would announce the set of addresses behind it, and packets would be sent in tunnel mode where the inner IP header would contain the IP addresses of the actual endpoints.

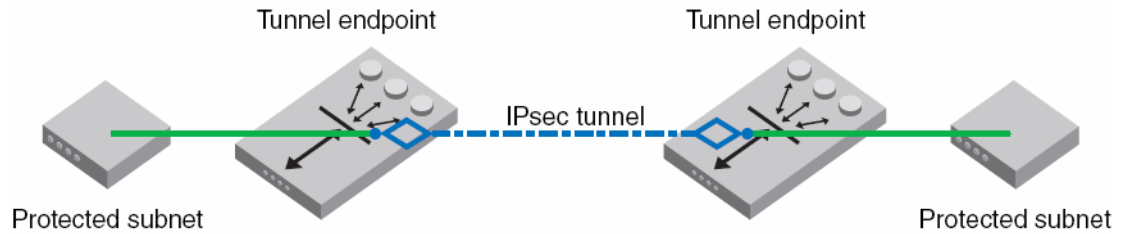

FIGURE 18 Gateway tunnel configuration

### Endpoint-to-Gateway Tunnel

In this scenario, a protected endpoint (typically a portable computer) connects back to its corporate network through an IPsec-protected tunnel. It might use this tunnel only to access information on the corporate network, or it might tunnel all of its traffic back through the corporate network in order to take advantage of protection provided by a corporate firewall against Internet-based attacks. In either case, the protected endpoint will want an IP address associated with the security gateway so that packets returned to it will go to the security gateway and be tunneled back.

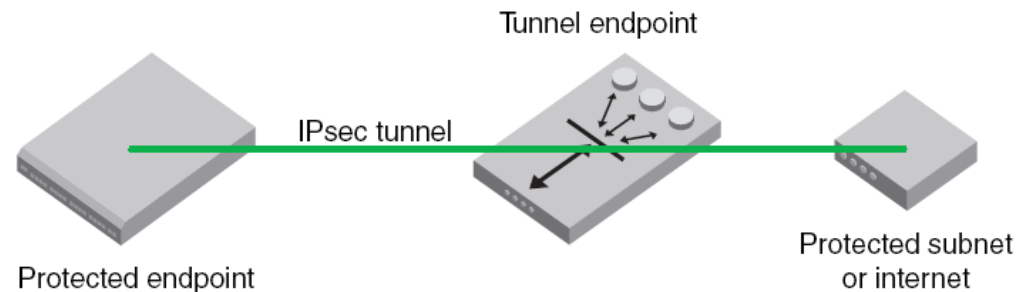

FIGURE 19 Endpoint to gateway tunnel configuration

### RoadWarrior configuration

In endpoint-to-endpoint security, packets are encrypted and decrypted by the host which produces or consumes the traffic. In the gateway-to-gateway example, a router on the network encrypts and decrypts the packets on behalf of the hosts on a protected network. A combination of the two is referred to as a RoadWarrior configuration where a host on the internet requires access to a network through a security gateway that is protecting the network.

## IPsec protocols

IPsec uses two different protocols, Authentication Header (AH) and Encapsulating Security Payload (ESP), to ensure the authentication, integrity and confidentiality of the communication.

To protect the integrity of the IP datagram, the IPsec protocols use hash message authentication codes (HMAC). To derive this HMAC, the IPsec protocols use hash algorithms like MD5 and SHA to calculate a hash based on a secret key and the contents of the IP datagram. This HMAC is then included in the IPsec protocol header and the receiver of the packet can check the HMAC if it has access to the secret key.

To protect against denial of service attacks, the IPsec protocols use a sliding window. Each packet gets assigned a sequence number and is only accepted if the packet's number is within the window or newer. Older packets are immediately discarded. This protects against replay attacks where the attacker records the original packets and replays them later.

## Security associations

A security association (SA) is the collection of security parameters and authenticated keys that are negotiated between IPsec peers. For the peers to be able to encapsulate and decapsulate the IPsec packets, they need a way to store the secret keys, algorithms, and IP addresses involved in the communication. All these parameters needed for the protection of the IP datagram are stored in a security association (SA). The security associations are in turn stored in a security association database (SADB).

An IPsec security association is a construct that specifies security properties that are recognized by communicating hosts. The properties of the SA are the security protocol (AH or ESP), destination IP address, and Security Parameter Index (SPI) number. SPI is an arbitrary 32-bit value contained in IPsec protocol headers (AH or ESP) and an IPsec SA is unidirectional. Because most communication is peer-to-peer or client-to-server, two SAs must be present to secure traffic in both directions. An SA specifies the IPsec protocol (AH or ESP), the algorithms used for encryption and authentication, and the expiration definitions used in security associations of the traffic. IKE uses these values in negotiations to create IPsec SAs. You must create an SA prior to creating an SA-proposal. You cannot modify an SA once it is created. Use the **ipsecConfig --flush manual-sa** command to remove all SA entries from the kernel SADB and re-create the SA. For more information on the **ipSecConfig** command, refer to the *Fabric OS Command Reference*.

### *IPsec proposal*

The IPsec sa-proposal defines an SA or an SA bundle. An SA is a set of parameters that define how the traffic is protected using IPsec. These are the IPsec protocols to use for an SA, either AH or ESP, and the encryption and authentication algorithms to use to protect the traffic. For SA bundles, [AH, ESP] is the supported combination.

## Authentication and encryption algorithms

IPsec uses different protocols to ensure the authentication, integrity, and confidentiality of the communication. Encapsulating Security Payload (ESP) provides confidentiality, data integrity and data source authentication of IP packets, and protection against replay attacks. Authentication Header (AH) provides data integrity, data source authentication, and protection against replay attacks, but unlike ESP, AH does not provide confidentiality.

In AH and ESP, `hmac_md5` and `hmac_sha1` are used as authentication algorithms. Only in ESP, `3des_cbc`, `blowfish_cbc`, `aes256_cbc` and `null_enc` are used as encryption algorithms. Use [Table 41](#) on page 168 when configuring the authentication algorithm.

**TABLE 41 Algorithms and associated authentication policies**

Algorithm	Encryption Level	Policy	Description
hmac_md5	128-bit	AH, ESP	A stronger MAC because it is a keyed hash inside a keyed hash. When MD5 or SHA-1 is used in the calculation of an HMAC; the resulting MAC algorithm is termed HMAC-MD5 or HMAC-SHA-1 accordingly. <b>NOTE:</b> The MD5 hash algorithm is blocked when FIPS mode is enabled
hmac_sha1	160-bit	AH, ESP	
3des_cbc	168-bit	ESP	Triple DES is a more secure variant of DES. It uses three different 56-bit keys to encrypt blocks of 64-bit plain text. The algorithm is FIPS-approved for use by Federal agencies.
blowfish_cbc	64-bit	ESP	Blowfish is a 32-bit to 448-bit keyed, symmetric block cipher.
aes128_cbc	128-bit	ESP	Advanced Encryption Standard is a 128- or 256-bit fixed block size cipher.
aes256_cbc	256-bit	ESP	
null_enc	n/a	ESP	A form of plaintext encryption.

## IPsec policies

An IPsec policy determines the security services afforded to a packet and the treatment of a packet in the network. An IPsec policy allows classifying IP packets into different traffic flows and specifies the actions or transformations performed on IP packets on each of the traffic flows. The main components of an IPsec policy are: IP packet filter and selector (IP address, protocol, and port information) and transform set.

### *IPsec traffic selector*

The traffic selector is a traffic filter that defines and identifies the traffic flow between two systems that have IPsec protection. IP addresses, the direction of traffic flow (inbound, outbound) and the upper layer protocol are used to define a filter for traffic (IP datagrams) that is protected using IPsec.

### *IPsec transform*

A *transform set* is a combination of IPsec protocols and cryptographic algorithms that are applied on the packet after it is matched to a selector. The transform set specifies the IPsec protocol, IPsec mode and action to be performed on the IP packet. It specifies the key management policy that is needed for the IPsec connection and the encryption and authentication algorithms to be used in security associations when IKE is used as the key management protocol.

IPsec can protect either the entire IP datagram or only the upper-layer protocols. The appropriate modes are called *tunnel mode* and *transport mode*. In tunnel mode the IP datagram is fully encapsulated by a new IP datagram using the IPsec protocol. In transport mode only the payload of the IP datagram is handled by the IPsec protocol; it inserts the IPsec header between the IP header and the upper-layer protocol header.



## IKE policies

When IKE is used as the key management protocol, IKE policy defines the parameters used in IKE negotiations needed to establish IKE SA and parameters used in negotiations to establish IPsec SAs. These include the authentication and encryption algorithms, and the primary authentication method, such as preshared keys, or a certificate-based method, such as RSA signatures.

### *Key management*

The IPsec key management supports Internet Key Exchange or Manual key/SA entry. The Internet Key Exchange (IKE) protocol handles key management automatically. SAs require keying material for authentication and encryption. The managing of keying material that SAs require is called *key management*.

The IKE protocol solves the most prominent problem in the setup of secure communication: the authentication of the peers and the exchange of the symmetric keys. It then creates the security associations and populates the SADB.

The manual key/SA entry requires the keys to be generated and managed manually. For the selected authentication or encryption algorithms, the correct keys must be generated using a third party utility on your LINUX system. The key length is determined by the algorithm selected.

Linux IPsec-tools 0.7 provides tools for manual key entry (MKE) and automatic keyed connections. The LINUX **setKey** command can be used for manually keyed connections, which means that all parameters needed for the setup of the connection are provided by you. Based on which protocol, algorithm, and key used for the creation of the security associations, the switch populates the security association database (SAD) accordingly.

### *Pre-shared keys*

A pre-shared key has the .psk extension and is one of the available methods IKE can be configured to use for primary authentication. You can specify the pre-shared keys used in IKE policies; add and delete pre-shared keys (in local database) corresponding to the identity of the IKE peer or group of peers.

The **ipSecConfig** command does not support manipulating pre-shared keys corresponding to the identity of the IKE peer or group of peers. Use the **secCertUtil** command to import, delete, or display the pre-shared keys in the local switch database. For more information on this procedure, refer to [Chapter 6, “Configuring Protocols”](#).

### *Security certificates*

A certificate is one of the available methods IKE can be configured to use for primary authentication. You can specify the local public key and private key (in X.509 PEM format) and peer public key (in X.509 format) to be used in a particular IKE policy.

Use the **secCertUtil import** command to import public key, private key and peer-public key (in X.509 PEM format) into the switch database. For more information on this procedure, refer to [Chapter 6, “Configuring Protocols”](#).

---

#### ATTENTION

The CA certificate name must have the **IPSECCA.pem** name.

---

## Static Security Associations

Manual Key Entry (MKE) provides the ability to manually add, delete and flush SA entries in the SADB. Manual SA entries may not have an associated IPsec policy in the local policy database. Manual SA entries are persistent across system reboots.

## Creating the tunnel

These instructions do not take the place of creating a tunnel for either a FR4-18i or FX8-24. For information on creating tunnels for those application blades, refer to the *Fibre Channel over IP Administrator's Guide*

Each side of the tunnel must be configured in order for the tunnel to come up. Once you are logged into the switch, do not log off as each step requires that you are logged in to the switch. IPsec configuration changes take effect upon execution and are persistent across reboots. Configure the following on each side of the tunnel:

---

### NOTE

A backslash ( \ ) is used to skip the return character so you can continue the command on the next line without the return character being interpreted by the shell.

---

1. Determine the authentication protocol and algorithm to be used on the tunnel.  
Refer to [Table 41](#) on page 168 to determine which algorithm to use in conjunction with a specific authentication protocol.
2. Determine the type of keys to be used on the tunnel.  
If you are using CA signed keys, you must generate them prior to setting up your tunnels.
3. Enable IPsec.
  - a. Connect to the switch and log in using an account assigned to the admin role.
  - b. Enter the `ipSecConfig --enable` command to enable IPsec on the switch.
4. Create an IPsec SA policy on each side of the tunnel using the `ipSecConfig --add` command.

#### Example of creating an IPsec SA policy

This example creates an IPsec SA policy named *AH01*, which uses AH protection with MD5. You would run this command on each switch; on each side of the tunnel so that both sides have the same IPsec SA policy.

```
switch:admin> ipsecconfig --add policy ips sa -t AH01 -p ah -auth hmac_md5
```

5. Create an IPsec proposal on each side of the tunnel using the `ipSecConfig --add` command.

#### Example of creating an IPsec proposal

This example creates an IPsec proposal *IPSEC-AH* to use *AH01* as SA.

```
switch:admin> ipsecconfig --add policy ips sa-proposal -t IPSEC-AH -sa AH01
```

6. Import the pre-shared key file.  
Refer to [Chapter 6, "Configuring Protocols"](#) for information on how to set up pre-shared keys and certificates.
7. Configure the IKE policy using the `ipSecConfig --add` command.

**Example of creating an IKE policy**

This example creates an IKE policy for the remote peer.

```
switch:admin> ipsecconfig --add policy ike -t IKE01 -remote 10.33.74.13 \
-id 10.33.69.132 -remoteid 10.33.74.13 -enc 3des_cbc \
-hash hmac_md5 -prf hmac_md5 -auth psk -dh modp1024 \
-psk ipseckey.psk
```

8. Create an IPsec transform on each switch using the **ipSecConfig --add** command.

**Example of creating an IPsec transform**

This example creates an IPsec transform TRANSFORM01 to use the transport mode to protect traffic identified for IPsec protection and use IKE01 as key management policy.

```
switch:admin> ipsecconfig --add policy ips transform -t TRANSFORM01 \
-mode transport -sa-proposal IPSEC-AH \
-action protect -ike IKE01
```

9. Create a traffic selector on each switch using the **ipSecConfig --add** command.

**Example of creating a traffic selector**

This example creates a traffic selector to select outbound and inbound traffic that needs to be protected.

```
switch:admin> ipsecconfig --add policy ips selector -t SELECTOR-OUT \
-d out -l 10.33.74.13 -r 10.33.69.132 -transform TRANSFORM01
```

```
switch:admin> ipsecconfig --add policy ips selector -t SELECTOR-IN \
-d in -l 10.33.69.132 -r 10.33.74.13 -t transform TRANSFORM01
```

10. Verify traffic is protected.

- a. Initiate a telnet, SSH, or ping session from the two switches.
- b. Verify that IP traffic is encapsulated.
- c. Monitor IPsec SAs created using IKE for above traffic flow
  - Use the **ipSecConfig --show manual-sa -a** command with the operands specified to display the outbound and inbound SAs in kernel SADB.
  - Use the **ipSecConfig --show policy ips sa -a** command with the specified operands to display all IPsec SA policies.
  - Use the **ipSecConfig --show policy ips sa-proposal -a** command with the specified operands to display IPsec proposals.
  - Use the **ipSecConfig --show policy ips transform -a** command with the specified operands to display IPsec transforms.
  - Use the **ipSecConfig --show policy ips selector -a** command with the specified operands to display IPsec traffic selectors.
  - Use the **ipSecConfig --show policy ike -a** command with the specified operands to display IKE policies.
  - Use the **ipSecConfig --flush manual-sa** command with the specified operands to flush the created SAs in the kernel SADB.

## Example of an End-to-End Transport Tunnel mode

This example illustrates securing traffic between two systems using AH protection with MD5 and configure IKE with pre-shared keys. The two systems are a switch, BROCADE300 (IPv4 address 10.33.74.13), and an external host (10.33.69.132).

---

### NOTE

A backslash ( \ ) is used to skip the return character so you can continue the command on the next line without the return character being interpreted by the shell.

---

1. On the system console, log in to the switch as Admin.
2. Enable IPsec.
  - a. Connect to the switch and log in using an account assigned to the admin role.
  - b. Enter the **ipSecConfig --enable** command to enable IPsec on the switch.
3. Create an IPsec SA policy named AH01, which uses AH protection with MD5.

```
switch:admin> ipsecconfig --add policy ips sa -t AH01 \
-p ah -auth hmac_md5
```

4. Create an IPsec proposal IPSEC-AH to use AH01 as SA.

```
switch:admin> ipsecconfig --add policy ips sa-proposal \
-t IPSEC-AH -sa AH01
```

5. Configure the SA proposal's lifetime in time units.

```
switch:admin> ipsecconfig --add policy ips sa-proposal \
-t IPSEC-AH -ltime 280000 -sa AH01
```

6. Import the pre-shared key file using the **secCertUtil** command. The file name should have a .psk extension.

For more information on importing the pre-shared key file, refer to [“Installing a switch certificate”](#) on page 125.

7. Configure an IKE policy for the remote peer.

```
switch:admin> ipsecconfig --add policy ike -t IKE01 \
-remote 10.33.69.132 -id 10.33.74.13 -remoteid 10.33.69.132 \
-enc 3des_cbc -hash hmac_md5 -prf hmac_md5 -auth psk \
-dh modp1024 -psk ipseckey.psk
```

---

### NOTE

IKE version ('-v' option) needs to be set to 1 (IKEv1) if remote peer is a Windows XP or 2000 Host as Windows XP and 2000 do not support IKEv2.

---

8. Create an IPsec transform named TRANSFORM01 to use transport mode to protect traffic identified for IPsec protection and use IKE01 as key management policy.

```
switch:admin> ipsecconfig --add policy ips transform \
-t TRANSFORM01 -mode transport -sa-proposal IPSEC-AH -action \
protect -ike IKE01
```

9. Create traffic selectors to select the outbound and inbound traffic that needs to be protected.

```
switch:admin> ipsecconfig --add policy ips selector \
-t SELECTOR-OUT -d out -l 10.33.74.13 -r 10.33.69.132 \
-transform TRANSFORM01
switch:admin> ipsecconfig --add policy ips selector \
```

```
-t SELECTOR-IN -d in -l 10.33.69.132 -r 10.33.74.13 \
-transform TRANSFORM01
```

10. Verify the IPsec SAs created with IKE using the **ipsecConfig --show manual-sa -a** command.
11. Perform the equivalent steps on the remote peer to complete the IPsec configuration. Refer to your server administration guide for instructions.
12. Generate IP traffic and verify that it is protected using defined policies.
  - a. Initiate Telnet or SSH or ping session from BRCD300 to Remote Host.
  - b. Verify that the IP traffic is encapsulated.
  - c. Monitor IPsec SAs created using IKE for the above traffic flow.
    - Use the **ipSecConfig --show manual-sa -a** command with the operands specified to display the outbound and inbound SAs in the kernel SADB.
    - Use the **ipSecConfig --show policy ips sa -a** command with the specified operands to display all IPsec SA policies.
    - Use the **ipSecConfig --show policy ips sa-proposal -a** command with the specified operands to display IPsec proposals.
    - Use the **ipSecConfig --show policy ips transform -a** command with the specified operands to display IPsec transforms.
    - Use the **ipSecConfig --show policy ips selector -a** command with the specified operands to display IPsec traffic selectors.
    - Use the **ipSecConfig --show policy ike -a** command with the specified operands to display IKE policies.
    - Use the **ipSecConfig --flush manual-sa** command with the specified operands to flush the created SAs in the kernel SADB.

**CAUTION**

Flushing SAs requires IPsec to be disabled and re-enabled. This operation is disruptive to traffic on the tunnel.

## 7 Management interface security

# Maintaining the Switch Configuration File

---

## In this chapter

- Configuration settings ..... 175
- Configuration file backup ..... 178
- Configuration file restoration ..... 180
- Configurations across a fabric ..... 184
- Configuration management for Virtual Fabrics ..... 184
- Brocade configuration form ..... 187

## Configuration settings

It is important to maintain consistent configuration settings on all switches in the same fabric because inconsistent parameters, such as inconsistent PID formats, can cause fabric segmentation. As part of standard configuration maintenance procedures, it is recommended that you back up all important configuration data for every switch on a host computer server for emergency reference.

---

### NOTE

For information about AD-enabled switches, refer to [Chapter 15, “Managing Administrative Domains”](#).

For more information about troubleshooting configuration file uploads and downloads, refer to the *Fabric OS Troubleshooting and Diagnostics Guide*.

---

There are two ways to view configuration settings for a switch in a Brocade fabric:

- Issue the **configShow -all** command.  
To display configuration settings, connect to the switch, log in as admin, and enter the **configShow -all** command. The configuration settings vary depending on switch model and configuration. This command does not show as much configuration information as the text file created from the **configUpload** command.
- Issue the **configUpload -all** command to upload an ASCII text file from the switch or switch module.  
You can open the text file with a text file editor to view the configuration information of the switch.

**CAUTION**

**Editing of the uploaded file is unsupported and can result in system errors if an edited file is subsequently downloaded.**

If you have the chassis role permissions added to your user account, then the following options are available whether you are uploading or downloading a configuration file:

- fid** Uploads the specified FID configuration.
- all** Uploads all of the system configuration, including the chassis section and all switch sections for all logical switches.  
**Note:** Use this parameter when obtaining a complete capture of the switch configuration in a switch that has Virtual Fabric mode disabled.
- chassis** Uploads only the chassis section of the system configuration file.

## Configuration file format

The configuration file is divided into three areas: the header, the chassis section, and one or more switch sections. If you upgrade the firmware on any existing switches from pre-Fabric OS v6.2.0 to v6.2.0, then you must perform the **configUpload** command to upload both chassis and switch information.

**CAUTION**

**If you have Virtual Fabrics enabled, you must follow the procedure in [“Configuration management for Virtual Fabrics”](#) on page 184 to restore the logical switches.**

**Example of a configuration file**

```
[Configuration upload Information]
Configuration Format = 2.0
date = Thu Apr  2 21:28:52 2009
FOS version = v6.3.0.0
Number of LS = 2

[Chassis Configuration Begin]

[fcRouting]

[Chassis Configuration]

[LicensesDB]

[Bottleneck Configuration]

[DMM_WWN]

[Licenses]

[Chassis Configuration End]
date = Thu Apr  2 21:28:52 2009
```



```
[Switch Configuration Begin : 0]
SwitchName = Sprint5100
Fabric ID = 128
```

```
[Boot Parameters]
```

```
[Configuration]
```

```
[Bottleneck Configuration]
```

```
[Zoning]
```

```
[Defined Security policies]
```

```
[Active Security policies]
```

```
[iSCSI]
```

```
[cryptoDev]
```

```
[FICU SAVED FILES]
```

```
[Banner]
```

```
[End]
```

```
[Switch Configuration End : 0]
date = Thu Apr  2 21:28:52 2009
```

```
[Switch Configuration Begin : 1]
SwitchName = switch_2
Fabric ID = 1
```

```
[Boot Parameters]
```

```
[Configuration]
```

```
[Bottleneck Configuration]
```

```
[Zoning]
```

```
[Defined Security policies]
```

```
[Active Security policies]
```

```
[iSCSI]
```

```
[cryptoDev]
```

```
[FICU SAVED FILES]
```

```
[Banner]
```

```
[End]
```

```
[Switch Configuration End : 1]
```

### *Chassis section*

There is only one chassis section within a configuration. It defines configuration data for chassis components that affects the entire system—not just an individual logical switch. The chassis section is included in non-Virtual Fabric modes only if you use the **configUpload -all** command. The following software components are defined in the chassis area:

- FC Routing
- Chassis configuration
- FCoE chassis configuration
- Licenses DB
- Bottleneck configuration
- DMM\_WWN
- Licenses
- GE blade mode
- Fabric Watch chassis configuration

### *Switch section*

There is always at least one switch section for the default switch or a switch that has Virtual Fabric mode disabled, and there are additional sections corresponding to each additionally defined logical switch instance on a switch with Virtual Fabric mode enabled. These are the switch-specific data that affect only that logical switch behavior. The following components are in the switch section of the configuration file:

- Boot parameters
- Configuration
- Bottleneck configuration
- FCOE configuration
- Zoning
- Defined security policies
- Active security policies
- iSCSI
- CryptoDev
- FICU saved files

## Configuration file backup

In case the configuration is lost or unintentional changes are made, keep a backup copy of the configuration file. You should keep individual backup files for all switches in the fabric and avoid copying configurations from one switch to another. The **configUpload** command, by default, only uploads the switch context configuration for the logical switch context in which the command is executed.

In non-Virtual Fabric mode, you must use the **configUpload -all** command to include both the switch and the chassis information. In Virtual Fabric mode, the **configUpload -all** command can be selected to upload all logical switches and the chassis configuration. Only administrators with the chassis role permission are allowed to upload other FIDs or the chassis configuration.

The following information is *not* saved in a backup:

- **dnsConfig** information
- Passwords

Before beginning, verify that you can reach the FTP server from the switch. Using a Telnet connection, save a backup copy of the configuration file from a logical switch to a host computer.

## Uploading a configuration file in interactive mode

1. Verify that the FTP or SCP service is running on the host computer.
2. Connect to the switch and log in as admin.
3. Enter the **configUpload** command. The command becomes interactive and you are prompted for the required information.
4. Store a soft copy of the switch configuration information in a safe place for future reference.

---

### NOTE

The configuration file is printable, but you may want to see how many pages will be printed before you send it to the printer.

---

#### Example of configUpload on a switch without Admin Domains

```
switch:admin> configupload
Protocol (scp, ftp, local) [ftp]:
Server Name or IP Address [host]: 10.1.2.3
User Name [user]: UserFoo
Path/File name [<home dir>/config.txt]: switchConfig.txt
Section (all|chassis|FID# [all]): chassis
Password: <hidden>

configUpload complete
```

#### Example of configUpload on a switch with Admin Domains

---

### NOTE

AD domains other than AD255 upload a subset of information. If you want a complete switch configuration, you need use the **configUpload** command while logged into AD255.

---

```
switch:AD5:admin> ad --select 5
switch:AD5:admin> configUpload
Protocol (scp or ftp) [ftp]:
Server Name or IP Address [host]: 10.1.2.3
User Name [user]: UserFoo
Path/File name [<home dir>/config.txt]: /pub/configurations/config.txt
Password: <hidden>
configUpload complete: Only zoning parameters are uploaded from ad5.
```

## Configuration file restoration

Restoring a configuration involves overwriting the configuration on the switch by downloading a previously saved backup configuration file.



### CAUTION

**Make sure that the configuration file you are downloading is compatible with your switch model, because configuration files from other model switches or firmware versions might cause your switch to fail.**

If a **configDownload** command is issued on a non-FCR platform (for example, the configuration file from a Brocade 7500 downloads to a Brocade 7600), any FCR-like parameters may be viewed in the downloaded data. This is harmless to the switch and can be ignored.

Configuration management supports **configDownload** with Fabric OS v6.1.x or v6.2.0 configuration files. Configuration files from a system running Fabric OS v6.2.0 are not backward-compatible, and cannot be downloaded to a Fabric OS v6.1.0 or earlier system.

Configuration files downloaded from a system running Fabric OS v6.2.0 to a system running v6.3.0, and to a system running Fabric OS v6.3.0 to a system running v6.4.0, are applied only to the default switch or chassis areas. All other areas are not affected.

## Restrictions

The following limitations apply when restoring a configuration file:

- chassis** The number of switches defined in the downloaded config file must match the number of switches currently defined on the switch.
- fid FID** The FID must be defined in both the downloaded configuration file and the current system.
- fid FID -sfid FID** The **-fid FID** must be defined on the switch and the **-sfid FID** must be defined in the downloaded configuration file.

- all** The number of switches or FIDs defined in the downloaded configuration file must match the number of switches or FIDs currently defined on the switch.
- The switches must be disabled, if necessary (refer to “[Configuration download without disabling a switch](#)” on page 182 for more information on non-disruptive configuration downloads). If they are not, the **configDownload** command downloads the configuration for as many switches as possible until a non-disabled switch is encountered. Then it will stop. Before running this command, verify if any switches need to be disabled. If you are performing a **configDownload** due to a configuration error, it is highly recommended to perform a **configDefault** before running the **configDownload** command.
- In Virtual Fabric-enabled mode, the **chassisDisable** and **chassisEnable** commands are used to disable all logical switches on the affected switch. This bypasses the need to disable and enable each switch individually once the configuration download has completed.
- Non-Virtual Fabric configuration files downloaded to a Virtual Fabric system will only have configuration applied to the default switch. If there are multiple logical switches created in a Virtual Fabric-enabled system, there could be some issues if there are ports that belong to the default switch in a Virtual Fabric-disabled system, but are now assigned to logical switches in a Virtual Fabric-enabled system. Only configurations related to ports within the default switch will be applied.

In case something happens to your switch and you need to set it up again, run the commands listed in [Table 42](#) and save the output in a file format. Store the files in a safe place for emergency reference.

**TABLE 42** CLI commands to display or modify switch configuration information

Command	Displays
<b>configShow</b>	System configuration parameters and settings, and license information.
<b>fcLunQuery</b>	A list of LUN IDs and LUNs for all accessible targets.
<b>fcRouterPortCost</b>	FC Router route information.
<b>fcXlateConfig</b>	A translate (xlate) domain's domain ID for both EX_Port-attached fabric and backbone fabric.
<b>fosConfig</b>	Fabric OS features.
<b>ipAddrShow</b>	The IP address.
<b>iscsiCfg</b>	iSCSI entities.
<b>iscsiPortCfg</b>	The iSCSI port parameters.
<b>iscsiTargetName</b>	The IQN prefix.
<b>isnscCfg</b>	The configuration state of the iSNS client operation.
<b>licenseShow</b>	The license keys you have installed and provides better detail than the license information from the <b>configShow</b> command.
<b>portCfgEXPort</b>	EX_Port configuration parameters.
<b>portCfgVEXPort</b>	VEX_Port configuration parameters.

**CAUTION**

---

The switch has limited error checking and edited files may become corrupted and can lead to switch failures.

---

## Configuration download without disabling a switch

You can download configuration files to a switch while the switch is enabled; that is, you do not need to disable the switch for changes in SNMP, Fabric Watch, or ACL parameters. However, if there is any changed parameter that does not belong to SNMP, Fabric Watch, or ACL, then you must disable the switch. When you use the **configDownload** command, you will be prompted to disable the switch *only when necessary*.

Configuration download without disabling a switch is independent of the hardware platform and supported on all hardware platforms running Fabric OS v6.1.0 and later.

**ATTENTION**

---

In Fabric OS v6.2.0 and later, the configuration download process can only restore logical switches that already exist and with the same FIDs. It cannot be used to clone or repair the current switch because the **configDownload** command cannot create logical switches if they do not exist.

---

### *Restoring a configuration*

**CAUTION**

---

Using the SFID parameter erases all configuration information on the logical switch.

Use this parameter only when the logical switch has no configuration information you want to save.

---

1. Verify that the FTP service is running on the server where the backup configuration file is located.
2. Connect to the switch and log in using an account assigned to the admin role, and if necessary with the chassis-role permission.
3. If there are any changed parameters in the configuration file that do not belong to SNMP, Fabric Watch, or ACL, disable the switch by entering the **switchDisable** command.
4. Enter the **configDownload** command.  
The command becomes interactive and you are prompted for the required information.
5. At the “Do you want to continue [y/n]” prompt, enter **y**.
6. Wait for the configuration to be restored.
7. If you disabled the switch, enter the **switchEnable** command when the process is finished.

**NOTE**

---

Because some configuration parameters require a reboot to take effect, after you download a configuration file, you must reboot to be sure that the parameters are enabled. Before the reboot, this type of parameter is listed in the configuration file, but it is not effective until after the reboot.

---

**Example of configDownload without Admin Domains**

```
switch:admin> configdownload
Protocol (scp, ftp, local) [ftp]:
Server Name or IP Address [host]: 10.1.2.3
User Name [user]: UserFoo
Path/Filename [<home dir>/config.txt]:
Section (all|chassis|FID# [all]): all
```

\*\*\* CAUTION \*\*\*

This command is used to download a backed-up configuration for a specific switch. If using a file from a different switch, this file's configuration settings will override any current switch settings. Downloading a configuration file, which was uploaded from a different type of switch, may cause this switch to fail. A switch reboot might be required for some parameter changes to take effect.

configDownload operation may take several minutes to complete for large files.

Do you want to continue [y/n]: y

Password: <hidden>

configDownload complete.

**Example of configDownload with Admin Domains**

```
switch:AD5:admin>configdownload
Protocol (scp or ftp) [ftp]:
Server Name or IP Address [host]: 10.1.2.3
User Name [user]: UserFoo
Path/Filename [<home dir>/config.txt]: /pub/configurations/config.txt
```

\*\*\* CAUTION \*\*\*

This command is used to download a backed-up configuration for a specific switch. If using a file from a different switch, this file's configuration settings will override any current switch settings. Downloading a configuration file, which was uploaded from a different type of switch, may cause this switch to fail. A switch reboot might be required for some parameter changes to take effect.

configDownload operation may take several minutes to complete for large files.

Do you want to continue [y/n]: y

Password: <hidden>

Activating configDownload: Switch is disabled

configDownload complete: Only zoning parameters are downloaded to ad5.

**Example of a non-interactive download of all configurations (chassis + switches)**

```
configdownload -a -ftp 10.1.2.3,UserFoo,config.txt,password
```

## Configurations across a fabric

To save time when configuring fabric parameters and software features, you can save a configuration file from one switch and download it to other switches of the same model type, as shown in the following procedure.

Do not download a configuration file from one switch to another switch that is a different model or firmware version, because it can cause the switch to fail. If you need to reset affected switches, issue the **configDefault** command. Verify that all domain IDs are unique prior to using the **configDownload** command because the switches will segment if they all have the same domain ID.

If you download an existing configuration file to a switch that has a different Interoperable mode setting, the **configDownload** command will fail. You must first change the switch interoperability mode to equal that of the configuration file, reboot the switch, then re-download the configuration file.

### Downloading a configuration file from one switch to another same model switch

1. Configure one switch.
2. Use the **configUpload** command to save the configuration information. Refer to [“Configuration file backup”](#) on page 178 for more information.
3. Run **configDefault** on each of the target switches, and then use the **configDownload** command to download the configuration file to each of the target switches. Refer to [“Configuration file restoration”](#) on page 180 for more information.

### Security considerations

Security parameters and the switch identity cannot be changed by the **configDownload** command. Parameters such as the switch name and IP address (lines in the configuration file that begin with “boot”) are ignored. Security parameters (lines in the configuration file that begin with “sec”), such as secure mode setting and version stamp, are ignored.

For more detailed information on security, refer to [Chapter 6, “Configuring Protocols”](#).

## Configuration management for Virtual Fabrics

You can use the **configUpload -vf** or **configDownload -vf** command to restore configurations to a logical switch. The **-vf** option only restores the Virtual Fabrics configuration information on to a switch of the same model.

The Virtual Fabric configuration on the switch defines all of the logical switches allowed and configured for a particular platform.



## Uploading a configuration file from a switch with Virtual Fabrics enabled

The **configUpload** command with the **-vf** option specifies that configuration upload will upload the Virtual Fabric configuration instead of the non-Virtual Fabric configuration information.

You must specify a filename with the **configUpload -vf** command. It is recommended not to use **config.txt** for a filename as this can easily be confused with a normal uploaded configuration file.

### Example of configUpload on a switch with Virtual Fabrics

```
Sprint5100:FID128:admin> configupload
Protocol (scp, ftp, local) [ftp]:
Server Name or IP Address [host]: 10.1.2.3
User Name [user]: UserFoo
Path/File name [<home dir>/config.txt]: 5100.txt
```

```
Potentially remote file may get overwritten
Section (all|chassis|FID# [all]):
Password: <hidden>
```

```
configUpload complete: All selected config parameters are uploaded
```

### Example of configUpload of a logical switch configuration

```
DCX_80:FID128:admin> configupload -vf
Protocol (scp, ftp, local) [ftp]:
Server Name or IP Address [host]: 10.1.2.3
User Name [user]: anonymous
Path/File name [<home dir>/config.txt]:
```

```
configUpload complete: VF config parameters are uploaded
2009/07/20-09:13:40, [LOG-1000], 225, SLOT 7 | CHASSIS, INFO, BrocadeDCX,
Previous message repeated 7 time(s)
2009/07/20-10:27:14, [CONF-1001], 226, SLOT 7 | FID 128, INFO, DCX_80,
configUpload completed successfully for VF config parameters.
```

## Restoring logical switch configuration using configDownload

The **configDownload -vf** command specifies that the Virtual Fabric configuration download file is downloaded instead of the regular configuration. After the Virtual Fabric configuration file is downloaded, the switch is automatically rebooted.

On dual-CP platforms, if CPs are incompatible (HA not in sync), the Virtual Fabric configuration file is not propagated to the standby CP. Otherwise, the active CP attempts to remain active after the reboot, and the new Virtual Fabric configuration file is then propagated to the standby CP.



### CAUTION

You must perform the **configDownload** command on the switch after restoring the Virtual Fabric configuration to fully restore your switch or chassis configuration.

1. Connect to the switch and log in using an account assigned to the admin role.
2. Enter the **configDownload -vf** command.
3. Respond to the prompts.
4. Wait for the configuration file to download onto the switch.  
You may need to reconnect to the switch.
5. Enter the **configDownload** command.
6. Respond to the prompts.
7. Wait for the configuration file to download to the switch.
8. Verify the LISL ports are set up correctly.

### Example of a non-interactive download from a switch with an FID = 8, to FID 10

```
configdownload -fid 8 -sfid 10 -ftp 10.1.2.3,UserFoo,config.txt,password
```

### Example of configDownload on a switch

```
5100:FID128:admin> configdownload -vf
Protocol (scp, ftp, local) [ftp]:
Server Name or IP Address [host]: 10.1.2.3
User Name [user]: UserFoo
Path/Filename [<home dir>/config.txt]: 5100_FID89.txt
```

\*\*\* CAUTION \*\*\*

This command is used to download the VF configuration to the switch. Afterwards, the switch will be automatically rebooted and the new VF settings will be used. You will then need to run configdownload again to install the configuration(s) for any logical switch(s) that are setup in the new VF configuration.

```
Do you want to continue [y/n]: y
(output truncated)
```

## Restrictions

The following restrictions should be observed when using the **configUpload** or **configDownload** commands when Virtual Fabrics is enabled:

- The **-vf** option is incompatible with the **-fid**, **-sfid**, or **-all** options. Any attempt to combine it with any of the other three will fail the configuration upload or download operation.
- You are not allowed to modify the Virtual Fabric configuration file after it has been uploaded. Only minimal verification is done by the **configDownload** command to ensure it is compatible, much like the normal downloaded configuration file.
- After the **configDownload -vf** command completes and reboots your switch, you must then download the matching regular configuration using the **configDownload -all** command. This ensures proper behavior of the system and logical switches.
- All of the attributes of the Virtual Fabric configuration file will be downloaded to the system and take effect. This includes, but is not limited to, logical switch definitions, whether the Virtual Fabrics feature is enabled or disabled, and the F\_Port trunking ports, except the LISL ports. The LISL ports on the system are not affected by the Virtual Fabric configuration file download.

## Brocade configuration form

Use the form in [Table 43](#) as a hard copy reference for your configuration information.

In the hardware reference manuals for the Brocade 48000 director and the Brocade DCX and DCX-4S enterprise-class platform, there is a guide for FC port setting tables. The tables can be used to record configuration information for the various blades.

**TABLE 43 Brocade configuration and connection**

<b>Brocade configuration settings</b>
IP address
Gateway address
Chassis configuration option
<b>Management connections</b>
Serial cable tag
Ethernet cable tag
<b>Configuration information</b>
Domain ID
Switch name
Ethernet IP address
Ethernet subnet mask
Total number of local devices ( <b>nsShow</b> )
Total number of devices in fabric ( <b>nsAllShow</b> )
Total number of switches in the fabric ( <b>fabricShow</b> )

## 8 Brocade configuration form

# Installing and Maintaining Firmware

---

## In this chapter

- Firmware download process overview ..... 189
- Preparing for a firmware download ..... 192
- Firmware download on switches ..... 193
- Firmware download on an enterprise-class platform ..... 196
- Firmware download from a USB device ..... 200
- FIPS Support ..... 201
- Test and restore firmware on switches ..... 203
- Test and restore firmware on enterprise-class platforms ..... 204
- Validating a firmware download ..... 207

## Firmware download process overview

Fabric OS v6.4.0 provides nondisruptive firmware installation.

This chapter refers to the following specific types of blades inserted into either the Brocade 48000 director or Brocade DCX and DCX-4S Backbone platforms:

- FC blades or port blades contain only Fibre Channel ports: Brocade FC4-16/32/48, FC10-6, and FC8-16/32/48/64.
- AP blades contain extra processors and specialized ports: Brocade FR4-18i and FC4-16IP, FA4-18, FCOE10-24, and FX8-24.
- CP blades have a control processor (CP) used to control the entire switch; they can be inserted only into slots 5 and 6 on the Brocade 48000, slots 6 and 7 on the Brocade DCX, and slots 4 and 5 on the Brocade DCX-4S.
- CORE8 and CR4S-8 core blades provide ICL functionality between two Brocade DCX Backbones. CORE8 blades can be inserted only into slots 5 and 8 on the Brocade DCX. CR4S-8 blades can be inserted only into slots 3 and 6 on the Brocade DCX-4S.

---

### NOTE

For more information on troubleshooting a firmware download, refer to the *Fabric OS Troubleshooting and Diagnostics Guide*.

---

You can download Fabric OS to a director, which is a chassis; and to a nonchassis-based system, also referred to as a switch. The difference in the download process is that directors have two CPs and nonchassis-based systems have one CP. Use the **firmwareDownload** command to download the firmware from either an FTP or SSH server by using either the FTP or SCP protocol to the switch.

Or, on the Brocade 300, 5100, 5300, 7800, 8000, and VA-40FC switches, the Brocade 5410, 5424, 5450, 5480 embedded switches, and the Brocade DCX and DCX-4S Backbones you can use a Brocade-branded USB device.

The new firmware consists of multiple files in the form of RPM packages listed in a `.plist` file. The `.plist` file contains specific firmware information (time stamp, platform code, version, and so forth) and the names of packages of the firmware to be downloaded. These packages are made available periodically to add features or to remedy defects. Contact your switch support provider to obtain information about available firmware versions.

All systems maintain two partitions of nonvolatile storage areas, a primary and a secondary, to store two firmware images. The firmware download process always loads the new image into the secondary partition. It then swaps the secondary partition to be the primary and high availability (HA) reboots (which is non-disruptive) the system. After the system boots up, the new firmware is activated. The firmware download process then copies the new image from the primary partition to the secondary partition.

---

### ATTENTION

The Brocade 8000 does not support a non-disruptive firmwareDownload. The switch reboots once the firmware upgrade or downgrade is complete.

---

In dual-CP systems, the firmware download process, by default, sequentially upgrades the firmware image on both CPs using HA failover to prevent disruption to traffic flowing through the enterprise-class platform. This operation depends on HA status on the enterprise-class platform. If the platform does not support HA, you can still upgrade the CPs one at a time.

**If you are using a Brocade 48000, or a Brocade DCX or DCX-4S enterprise-class platform, with one or more AP blades:** The Fabric OS automatically detects mismatches between the active CP firmware and the blade's firmware and triggers the auto-leveling process. This auto-leveling process automatically updates the blade firmware to match the active CP. At the end of the auto-leveling process, the active CP and the blade will run the same version of the firmware.

If the firmware download process is interrupted by an unexpected reboot, the system will automatically repair and recover the secondary partition. You must wait for the recovery to complete before issuing another **firmwareDownload** command.

The command supports both non-interactive and interactive modes. If the **firmwareDownload** command is issued without any operands, or if there is any syntax error in the parameters, the command enters an interactive mode, in which you are prompted for input

---

### ATTENTION

For each switch in your fabric, complete all firmware download changes on the current switch before issuing the **firmwareDownload** command on the next switch. This process ensures nondisruption of traffic between switches in your fabric.

To verify the firmwareDownload process is complete, enter the **firmwareDownloadStatus** command on the switch, verify the process is complete, then move on to the next switch.

---

## Upgrading and downgrading firmware

*Upgrading* means installing a newer version of firmware. *Downgrading* means installing an older version of firmware.

In most cases, you will be *upgrading* firmware; that is, installing a newer firmware version than the one you are currently running. However, some circumstances may require installing an older version; that is, *downgrading* the firmware. The procedures in this section assume that you are upgrading firmware, but they work for downgrading as well, provided the old and new firmware versions are compatible. Always reference the latest release notes for updates that may exist regarding downgrades under particular circumstances.

For details on Administrative Domains and the firmware download process, see [Chapter 15, “Managing Administrative Domains”](#) for more information.

For details about testing and restoring firmware, see [“Test and restore firmware on enterprise-class platforms”](#) on page 204.

## Considerations for FICON CUP environments

To prevent channel errors during nondisruptive firmware installation, the switch CUP port must be taken offline from all host systems.

### HA sync state

High availability (HA) synchronization occurs when two CPs in an enterprise-class platform are synchronized. This state provides redundancy and a non-disruptive firmware download. In order for a firmware download to successfully occur, the two CPs in an enterprise-class platform must be in sync.

If the CPs have mixed versions when you enter the `firmwareDownload` command, the CPs may not be in HA sync. In this case, you need to enter the `firmwareDownload -s` command first to upgrade or downgrade the standby CP to the same level as the active CP first, and then upgrade the CPs to the desired version of firmware.

---

#### NOTE

You should not run mixed firmware levels on CPs.

---

[Table 44](#) shows the sync state of an enterprise-class platform that has different Fabric OS versions installed on the active and standby CP. Use the table to determine if you need to use the `firmwareDownload -s` command.

**TABLE 44** Enterprise-class platform HA sync states

Active CP Fabric OS version	Standby CP Fabric OS version	HA sync state	Remedy
v6.2.0	v6.2.0	inSync	n/a
v6.2.x	v6.3.0	inSync	n/a
v6.3.0	v6.2.x	If Ethernet Switch Service is enabled, no sync.	Run <code>firmwareDownload -s</code> on the standby CP and upgrade it to v6.3.0.
v6.3.0	v6.3.0	inSync	n/a
v6.3.0	v6.4.0	InSync	n/a
v6.4.0	v6.3.0	inSync	Run <code>firmwareDownload -s</code> on the standby CP and upgrade it to v6.4.0.
v6.4.0	v6.4.0	inSync	n/a

A nondisruptive firmware download, which is performed by entering the **firmwareDownload** command without the **-s** operand, is only supported if you are upgrading from Fabric OS 6.1.x to 6.2.0. If you are downgrading from Fabric OS 6.2.0 to v6.1.x, you must enter the **firmwareDownload -s** command option as discussed in “[Test and restore firmware on switches](#)” on page 203 and “[Test and restore firmware on enterprise-class platforms](#)” on page 204. This procedure is not necessary when downgrading from Fabric OS v6.3.0 to v6.2.0 or from Fabric OS v6.4.0 to v6.3.0.

## Preparing for a firmware download

Before executing a firmware download, it is recommended that you perform the tasks listed in this section. In the unlikely event of a failure or time-out, these preparation tasks enable you to provide your switch support provider the information required to perform advanced troubleshooting.

It is recommended that you perform a **configUpload** to back up the current configuration before you download firmware to a switch. See “[Configuration file backup](#)” on page 178 for details.

1. Read the release notes for the new firmware to find out if there are any updates related to the firmware download process.
2. Connect to the switch and log in as admin. Enter the **firmwareShow** command to verify the current version of Fabric OS.

Brocade does not support upgrades from more than one previous release. For example, upgrading from Fabric OS v6.3.0 to v6.4.0 is supported, but upgrading from Fabric OS v6.2.0 or a previous release directly to v6.4.0 is not. In other words, upgrading a switch from Fabric OS v6.2.0 to v6.4.0 is a two-step process—first upgrade to v6.3.0, and then upgrade to v6.4.0. If you are running a pre-Fabric OS v6.2.0 you must upgrade to v6.2.0, then to v6.3.0, and finally to v6.4.0.

3. Perform a **configUpload** prior to the **firmwareDownload**. Save the config file on your FTP or SSH server or USB memory device on supported platforms.
4. *Optional:* For additional support, connect the switch to a computer with a serial console cable. Ensure that all serial consoles (both CPs for directors) and any open network connection sessions, such as Telnet, are logged and included with any trouble reports.
5. Connect to the switch and log in to the switch as admin. Enter the **supportSave** command to retrieve all current core files prior to executing the firmware download. This helps to troubleshoot the firmware download process if a problem is encountered.
6. *Optional:* Enter the **errClear** command to erase all existing messages in addition to internal messages.

### Connected switches

Before you upgrade the firmware on your switch you will need to check the connected switches to ensure compatibility and that any older versions are supported. Refer to the Fabric OS Compatibility section of the *Brocade Fabric OS Release Notes*, for the recommended firmware version.

---

#### NOTE

Go to <http://www.brocade.com> to view end-of-life policies for Brocade products. Navigate to the **Support** tab, then select **Policies and Locations**. Under **Important Note**, click on **End of Life Support**. End-of-life products are not supported.

---



If Brocade 300, 4100, 4900, 5000, 5410, 5424, 5450, 5460, 5470, 5480, 5100, 5300, 5424, 7500, 7500E, 7600, 7800, 8000, and VA-40FC switches are adjacent and you start firmware downloads on them at the same time, there may be traffic disruption.

To determine if you need to upgrade switches connected to the switch you are upgrading, use the following procedure on each connected switch to display firmware information and build dates

## Finding the switch firmware version

1. Connect to the switch and log in as admin.
2. Enter the **version** command.

The following information is displayed:

- **Kernel** displays the version of switch kernel operating system.
- **Fabric OS** displays the version of switch Fabric OS.
- **Made on** displays the build date of firmware running in switch.
- **Flash** displays the install date of firmware stored in nonvolatile memory.
- **BootProm** displays the version of the firmware stored in the boot PROM.

## Obtain and decompress firmware

Firmware upgrades are available for customers with support service contracts and for partners on the Brocade Web site at <http://www.brocade.com>.

At the Brocade Web site click *Brocade Connect*, log in, and follow the instructions to register and download firmware. Partners with authorized accounts can use the *Brocade Partner Network*.

You must decompress the firmware *before* you can use the **firmwareDownload** command to update the firmware on your equipment. Use the UNIX tar command for .tar files, the gunzip command for all .gz files, or a Windows unzip program for all .zip files

When you unpack the downloaded firmware, it expands into a directory that is named according to the version of Fabric OS it contains. For example, when you download and unzip v6.4.0.zip, it expands into a directory called v6.4.0. When you issue the **firmwareDownload** command, there is an automatic search for the correct package file type associated with the switch. Specify only the path up to and including the v6.4.0 directory.

## Firmware download on switches

Brocade 300, 4100, 4900, 5000, 5100, 5300, 5410, 5424, 5450, 5460, 5470, 5480, 7500, 7500E, 7600, 7800, 8000, and VA-40FC switches maintain primary and secondary partitions for firmware. The **firmwareDownload** command defaults to an autocommit option that automatically copies the firmware from one partition to the other.

---

**NOTE**

This section only applies when upgrading from Fabric OS v6.1.x to v6.2.0, or from different versions of v6.2.0, such as patch releases. If you are downgrading from v6.2.0 to v6.1.x, you must enter the **firmwareDownload -s** command as described in “[Test and restore firmware on switches](#)” on page 203.

This is not necessary when downgrading from Fabric OS v6.3.0 to v6.2.0 or from Fabric OS v6.4.0 to v6.3.0.

---

You should not override autocommit under normal circumstances; use the default. See “[Test and restore firmware on enterprise-class platforms](#)” on page 204 for details about overriding the autocommit option.

## Switch firmware download process overview

The following list describes the default behavior after you enter the **firmwareDownload** command (without options) on Brocade 300, 4100, 4900, 5000, 5410, 5424, 5450, 5460, 5470, 5480, 5100, 5300, 5424, 7500, 7500E, 7600, 7800, 8000, and VA-40FC switches:

- The Fabric OS downloads the firmware to the secondary partition.
- The system performs a high-availability reboot (**haReboot**). After the **haReboot**, the former secondary partition is the primary partition.
- The system replicates the firmware from the primary to the secondary partition.
- Software application (SA) software is upgraded only when **firmwareDownload** is issued with the **-a**, an SA option. Refer to the application’s manual for further information.

The upgrade process first downloads and then commits the firmware to the switch. While the upgrade is proceeding, you can start a session on the switch and use the **firmwareDownloadStatus** command to observe the upgrade progress if you wish.



**CAUTION**

After you start the process, do not enter any disruptive commands (such as reboot) that will interrupt the process. The entire firmware download and commit process takes approximately 17 minutes.

If there is a problem, wait for the time-out (30 minutes for network problems) before issuing the **firmwareDownload** command again. Disrupting the process can render the switch inoperable and require you to seek help from your switch service provider.

Do not disconnect the switch from power during the process because the switch could become inoperable when rebooted.

---

### ***Upgrading firmware for Brocade 300, 4100, 4900, 5000, 5100, 5300, 5410, 5424, 5450, 5460, 5470, 5480, 7500, 7500E, 7600, 7800, 8000, and VA-40FC switches.***

1. Take the following appropriate action based on what service you are using:
  - If you are using FTP or SCP, verify that the FTP or SSH server is running on the host server and that you have a valid user ID and password on that server.
  - If your platform supports a USB memory device, verify that it is connected and running.
2. Obtain the firmware file from the Brocade Web site at <http://www.brocade.com> and store the file on the FTP or SSH server or the USB memory device.
3. Unpack the compressed files preserving directory structures.
 

The firmware is in the form of RPM packages with names defined in a *.plist* file. The *.plist* file contains specific firmware information and the names of packages of the firmware to be downloaded.
4. Connect to the switch and log in as admin.
5. Issue the **firmwareShow** command to check the current firmware version on connected switches. Upgrade their firmware if necessary before proceeding with upgrading this switch.
 

See “[Connected switches](#)” on page 192 for details.
6. Enter the **firmwareDownload** command and respond to the prompts.

---

#### **NOTE**

If DNS is enabled and a server name instead of a server IP address is specified in the command line, **firmwareDownload** determines whether IPv4 or IPv6 should be used.

To be able to mention the FTP server by name, you must enter at least one DNS server using the **dnsConfig** command.

---

7. At the “Do you want to continue [y/n]” prompt, enter **y**.
8. After the HA reboot, connect to the switch and log in again as admin.
9. If you want snapshots of the upgrade progress, use a separate session and enter the **firmwareDownloadStatus** command to monitor the firmware download.
10. After the firmware commit is completed, which takes several minutes, enter the **firmwareShow** command to display the firmware level of both partitions.

#### **Example of an interactive firmware download**

```
switch:admin> firmwareDownload
Server Name or IP Address: 10.1.2.3
User Name: userfoo
File Name: /userfoo/firmware/v6.4.0
Network Protocol(1-auto-select, 2-FTP, 3-SCP) [1]: 2
Password: <hidden>
Checking system settings for firmwareDownload...
Trying address-->AF_INET IP: 10.1.2.3, flags : 2
System settings check passed.
```

You can run `firmwaredownloadstatus` to get the status of this command.

This command will cause a warm/non-disruptive boot on the switch, but will require that existing telnet, secure telnet or SSH sessions be restarted.

```
Do you want to continue [Y]: y  
Firmware is being downloaded to the switch. This step may take up to 30  
minutes.
```

## Firmware download on an enterprise-class platform

You can download firmware to a Brocade 48000, and to a Brocade DCX and DCX-4S enterprise-class platform without disrupting the overall fabric if the two CP blades are installed and fully synchronized. Use the **haShow** command to verify that the CPs are synchronized prior to beginning the firmware download process. If only one CP blade is inserted or powered on, you can run **firmwareDownload -s** to upgrade the CP. If the CPs are not in sync, you can run **firmwareDownload -s** on each of the CPs to upgrade them. These operations will be disruptive. Or if the CPs are not in sync, run the **haSyncStart** command. If the problem persists, refer to the *Fabric OS Troubleshooting and Diagnostics Guide*. If the troubleshooting information fails to help resolve the issue, contact your switch service provider.

---

### NOTE

This section only applies when upgrading from Fabric OS v6.1.x to v6.2.0, or from different versions of v6.2.0, such as patch releases. If you are downgrading from v6.2.0 to v6.1.x, you must enter the **firmwareDownload -s** command as described in [“Test and restore firmware on switches”](#) on page 203.

This is not necessary when downgrading from Fabric OS v6.3.0 to v6.2.0 or from Fabric OS v6.4.0 to v6.3.0.

---

During the upgrade process, the director fails over to its standby CP blade and the IP address for the enterprise-class platform moves to that CP blade's Ethernet port. This may cause informational ARP address reassignment messages to appear on other switches in the fabric. This is normal behavior, because the association between the IP addresses and MAC addresses has changed.

---

### ATTENTION

To successfully download firmware, you must have an active Ethernet connection on each of the CPs.

---

## Enterprise-class platform firmware download process overview

The following summary describes the default behavior of the **firmwareDownload** command (without options) on a Brocade 48000, a Brocade DCX and DCX-4S enterprise-class platforms. After you enter the **firmwareDownload** command on the active CP blade the following actions occur:

1. The standby CP blade downloads firmware.
2. The standby CP blade reboots and comes up with the new Fabric OS.
3. The active CP blade synchronizes its state with the standby CP blade.
4. The active CP blade forces a failover and reboots to become the standby CP blade.
5. The new active CP blade synchronizes its state with the new standby CP blade.

6. The *new standby* CP blade (the active CP blade before the failover) downloads firmware.
7. The *new standby* CP blade reboots and comes up with the new Fabric OS.
8. The new active CP blade synchronizes its state with the new standby CP blade.
9. The **firmwareCommit** command runs automatically on both CP blades.

**CAUTION**

After you start the process, do not enter any disruptive commands (such as reboot) that will interrupt the process. The entire firmware download and commit process takes approximately 17 minutes.

If there is a problem, wait for the time-out (30 minutes for network problems) before issuing the **firmwareDownload** command again. Disrupting the process can render the switch inoperable and require you to seek help from your switch service provider.

Do not disconnect the switch from power during the process because the switch could become inoperable when rebooted.

### *Upgrading firmware on enterprise-class platforms (including blades)*

There is only one chassis management IP address for the Brocade 48000 and the Brocade DCX and DCX-4s platforms.

**NOTE**

By default, the **firmwareDownload** command automatically upgrades both the active and standby CP on the Brocade 48000 director. It also automatically upgrades both the active and the standby CP and all co-CPs on the CP blades in the Brocade DCX and DCX-4S Backbones. It automatically upgrades all AP blades in the Brocade 48000, the Brocade DCX and DCX-4S platforms using auto-leveling.

1. Verify that the Ethernet interfaces located on CPO and CP1 are plugged into your network.
2. Verify that the FTP or SSH server is running on the host server and that you have a user ID on that server.
3. Obtain the firmware file from the Brocade Web site at <http://www.brocade.com> and store the file on the FTP or SSH server.

4. Unpack the compressed files preserving directory structures.

The firmware is in the form of RPM packages with names defined in a *.plist* file. The *.plist* file contains specific firmware information and the names of packages of the firmware to be downloaded.

5. Connect to the chassis IP management interface or active CP and log in as admin.
6. Use the **firmwareShow** command to check the current firmware version on connected switches. Upgrade the firmware, if necessary, before proceeding with upgrading this switch.

See “[Connected switches](#)” on page 192

7. Enter the **haShow** command to confirm that the two CP blades are synchronized.

In the following example, the active CP blade is CPO and the standby CP blade is CP1:

## 9 Firmware download on an enterprise-class platform

```
ecp:admin> hashow
Local CP (Slot 5, CP0): Active, Warm Recovered
Remote CP (Slot 6, CP1): Standby, Healthy
HA enabled, Heartbeat Up, HA State synchronized
```

CP blades must be synchronized and running Fabric OS v6.0.0 or later to provide a nondisruptive download. If the two CP blades are not synchronized, enter the **haSyncStart** command to synchronize them. If the CPs still are not synchronized, contact your switch service provider.

For further troubleshooting, refer to the *Fabric OS Troubleshooting and Diagnostics Guide*.

8. Enter the **firmwareDownload** command and respond to the interactive prompts.
9. At the “Do you want to continue [y/n]” prompt, enter **y**.

The firmware is downloaded to one CP blade at a time, beginning with the standby CP blade. During the process, the active CP blade fails over. After the firmware is downloaded, a firmware commit starts on both CP blades. The entire firmware download and commit process takes approximately 17 minutes.

**If an AP blade is present:** At the point of the failover an *autoleveling* process is activated. Autoleveling is triggered when the active CP detects a blade that contains a different version of the firmware, regardless of which version is older. Autoleveling downloads firmware to the AP blade, swaps partitions, reboots the blade, and copies the new firmware from the primary partition to the secondary partition. If you have multiple AP blades, they are updated simultaneously; however, the downloads can occur at different rates.

Autoleveling takes place in parallel with the firmware download being performed on the CPs, but does not impact performance. Fibre Channel traffic is not disrupted during autoleveling, but GbE traffic on AP blades may be affected.

```
ecp:admin> firmwaredownload
Type of Firmware (FOS, SAS, or any application) [FOS]:
Server Name or IP Address: 10.1.2.3
User Name: userfoo
File Name: /home/userfoo/v6.4.0
Network Protocol (1-auto-select, 2-FTP, 3-SCP) [1]:
Password: <hidden>
```

```
Checking version compatibility...
Version compatibility check passed.
```

The following AP blades are installed in the system.

Slot Name	Versions	Traffic Disrupted
3	FC4-16IP v6.4.0	GigE
2	FA4-18 v6.4.0	Virtualization
4	FR4-18i v6.4.0	None
10	FR4-18i v6.4.0	None

This command will upgrade the firmware on both CPs and all AP blade(s) above. If you want to upgrade firmware on a single CP only, please use **-s** option. You may run **firmwaredownloadstatus** to get the status of this" command.

This command will cause a warm/non-disruptive boot on the active CP, but will require that existing telnet, secure telnet or SSH sessions be restarted.

Do you want to continue [Y]: **y**

The firmware is being downloaded to the Standby CP. It may take up to 10 minutes

10. Optionally, after the failover, connect to the switch, and log in again as admin. Using a separate session to connect to the switch, enter the **firmwareDownloadStatus** command to monitor the firmware download status.

```
sw0:FID128:admin> firmwaredownloadstatus
[1]: Mon Mar 22 04:27:21 2010
Slot 7 (CP1, active): Firmware is being downloaded to the switch. This step
may take up to 30 minutes.

[2]: Mon Mar 22 04:34:58 2010
Slot 7 (CP1, active): Relocating an internal firmware image on the CP blade.

[3]: Mon Mar 22 04:35:29 2010
Slot 7 (CP1, active): The internal firmware image is relocated successfully.

[4]: Mon Mar 22 04:35:30 2010
Slot 7 (CP1, active): Firmware has been downloaded to the secondary partition
of the switch.

[5]: Mon Mar 22 04:37:24 2010
Slot 7 (CP1, standby): The firmware commit operation has started. This may
take up to 10 minutes.

[6]: Mon Mar 22 04:41:59 2010
Slot 7 (CP1, standby): The commit operation has completed successfully.

[7]: Mon Mar 22 04:41:59 2010
Slot 7 (CP1, standby): Firmwaredownload command has completed successfully.
Use firmwareshow to verify the firmware versions.
```

11. Enter the **firmwareShow** command to display the new firmware versions. Following is an example of **firmwareShow** output on the Brocade 48000 director.

```
switch:admin> firmwareshow
Slot Name      Appl  Primary/Secondary Versions      Status
-----
 2  FA4-18  FOS                v6.4.0
                   v6.4.0
                   SAS                v3.3.0
                   v3.3.0
                   DMM                v3.3.0
                   v3.3.0
 5  CP0     FOS                v6.4.0          Standby *
                   v6.4.0
 6  CP0     FOS                v6.4.0          Active
                   v6.4.0
 7  FA4-18  FOS                v6.4.0
                   v6.4.0
                   SAS                v3.3.0
                   v3.3.0
                   DMM                v3.3.0
                   v3.3.0
```

\* Local CP

## Firmware download from a USB device

The Brocade 300, 5100, 5300, 7800, 8000, and VA-40FC switches and the Brocade DCX and DCX-4S Backbones support a firmware download from a Brocade branded USB device attached to the switch or active CP. Before the USB device can be accessed by the **firmwareDownload** command, it must be enabled and mounted as a file system. The firmware images to be downloaded must be stored under the relative path from `/usb/usbstorage/brocade/firmware` or use the absolute path in the USB file system. Multiple images can be stored under this directory. There is a `firmwarekey` directory where the public key signed firmware is stored.

When the **firmwareDownload** command line option, `-U` (upper case), is specified, the **firmwareDownload** command downloads the specified firmware image from the USB device. When specifying a path to a firmware image in the USB device, you can only specify the relative path to `/firmware` or the absolute path.

### Enabling USB

1. Log in to the switch using an account assigned to the admin role.
2. Enter the **usbStorage -e** command.

### Viewing the USB file system

1. Log in to the switch using an account assigned to the admin role.
2. Enter the **usbStorage -l** command.

```
BrcdDCXBB:admin> usbstorage -l
firmware\                381MB    2010 Mar 28 15:33
  v6.4.0\                 381MB    2010 Mar 28 10:39
config\                  0B       2010 Mar 28 15:33
support\                 0B       2010 Mar 28 15:33
firmwarekey\            0B       2010 Mar 28 15:33
Available space on usbstorage 79%
```

### Downloading from USB using the relative path

1. Log in to the switch as admin.
2. Enter the **firmwareDownload -U** command.

```
ecp:admin>firmwaredownload -U v6.4.0
```

### Downloading from USB using the absolute path

1. Log in to the switch as admin.
2. Enter the **firmwareDownload** command with the `-U` operand.

```
ecp:admin>firmwaredownload -U /usb/usbstorage/brocade/firmware/v6.4.0
```



## FIPS Support

Federal information processing standards (FIPS) specify the security standards needed to satisfy a cryptographic module utilized within a security system for protecting sensitive information in the computer and telecommunication systems. For more information about FIPS, refer to [Chapter 7, “Configuring Security Policies”](#).

The v6.4.0 firmware is digitally signed using the OpenSSL utility to provide FIPS support. To use the digitally signed software, you must configure the switch to enable Signed Firmware download. If it is not enabled then the firmware download process ignores the firmware signature and work as before.

If Signed Firmware download is enabled, and if the validation succeeds, the firmware download process proceeds normally. If the firmware is not signed or if the signature validation fails, **firmwareDownload** fails.

To enable or disable FIPS, refer to [Chapter 7, “Configuring Security Policies”](#).

### Public and Private Key Management

For signed firmware, Brocade uses RSA with 1024-bit length key pairs, a private key and a public key. The private key is used to sign the firmware files when the firmware is generated. The public key is packaged in an RPM-package as part of the firmware, and is downloaded to the switch. After it is downloaded, it can be used to validate the firmware to be downloaded next time when you run the **firmwareDownload** command.

The public key file on the switch contains only one public key. It is only able to validate firmware signed using one corresponding private key. If the private key changes in future releases, you need to change the public key on the switch by one of the following methods:

- By using the **firmwareDownload** command. When a new firmware is downloaded, **firmwareDownload** always replaces the public key file on the switch with what is in the new firmware. This allows you to have planned firmware key changes.
- By using the **firmwareKeyUpdate** command. This command retrieves a specified public key file from a specific server location and replaces the one on the switch. So for easy access, the information regarding firmware versions and their corresponding public key files should be documented in the release notes or stored in a known location in the Brocade website. This command allows the customer to handle unplanned firmware key changes.

---

#### NOTE

If FIPS is enabled, all logins should be done through SSH or direct serial and the transfer protocol should be SCP.

---

#### *Updating the firmwarekey*

1. Log in to the switch as admin.
2. Type the **firmwareKeyUpdate** command and respond to the prompts.

### The firmwareDownload Command

As mentioned previously, the public key file will need to be packaged, installed, and run on your switch before downloading a signed firmware.

When firmwareDownload installs a firmware file, it needs to validate the signature of the file. Different scenarios are handled as follows:

- If a firmware file does not have a signature, how it is handled depends on the “signed\_firmware” parameter on the switch. If it is enabled, firmwareDownload will fail. Otherwise, firmwareDownload will display a warning message and proceed normally. So when downgrading to a non-FIPS compliant firmware, the “signed\_firmware” flag needs to be disabled.
- If the firmware file has a signature but the validation fails, firmwareDownload will fail. This means the firmware is not from Brocade or its content has been modified.
- If the firmware file has a signature and the validation succeeds, firmwareDownload will proceed normally.

SAS, DMM, and third party application images are not signed.

### *Configuring the switch for signed firmware*

1. Connect to the switch and log in using an account assigned to the admin role.
2. Type the **configure** command.
3. Respond to the prompts as follows:

<i>System Service</i>	Default is no; press Enter to select default setting.
<i>ssl attributes</i>	Default is no; press Enter to select default setting.
<i>snmp attributes</i>	Default is no; press Enter to select default setting.
<i>rpcd attributes</i>	Default is no; press Enter to select default setting.
<i>cfgload attributes</i>	<b>Select Yes.</b> The following questions are displayed:
	<b>Enforce secure config Upload/Download:</b> Select yes
	<b>Enforce signed firmware download:</b> Select yes
<i>Webtools attributes</i>	Default is no; press Enter to select default setting.
<i>System</i>	Default is no; press Enter to select default setting.

## Power-on Firmware Checksum Test

FIPS requires the checksums of the executables and libraries on the filesystem to be validated before Fabric OS modules are launched. This is to make sure these files have not been changed after they are installed.

When firmware RPM packages are installed during firmwareDownload, the MD5 checksums of the firmware files are stored in the RPM database on the filesystem. The checksums go through all of the files in the RPM database. Every file compares its current checksum with the checksum that is in the RPM database. If they are different, the command displays an output message informing you of the difference.

Because the validation may take up to a few minutes, it will not be performed during hot code load. It is only performed after a cold reboot of the switch.

For more information on FIPS, see [Chapter 7, “Configuring Security Policies”](#).

## Test and restore firmware on switches

---

### NOTE

This section does not apply to SAS or storage applications applied to the FA4-18 AP blade.

---

Typically, users downgrade firmware after briefly evaluating a newer (or older) version and then restore the original version of the firmware. Testing a new version of firmware in this manner ensures that you do not replace existing firmware because the evaluated version occupies only one partition on the switch.

---

### ATTENTION

When you evaluate new firmware, make sure you disabled all features that are not supported by the original firmware before restoring to the original version.

---

## Testing a different firmware version on a switch

1. Verify that the FTP or SSH server is running on the host server and that you have a user ID on that server.
2. Obtain the firmware file from the Brocade Web site at <http://www.brocade.com> or switch support provider and store the file on the FTP or SSH server.
3. Unpack the compressed files preserving directory structures.

The firmware is in the form of RPM packages with names defined in a *.plist* file, that contains specific firmware information and the names of packages of the firmware to be downloaded.

4. Connect to the switch and log in as admin.
5. Enter the **firmwareShow** command to view the current firmware.
6. Enter the **firmwareDownload -s** command to update the firmware and respond to the prompts.

### Example of a firmwareDownload to a single partition

```
ecp:admin> firmwareDownload -s
Type of Firmware (FOS, SAS, or any application) [FOS]:
Server Name or IP Address: 10.1.2.3
Network Protocol (1-auto-select, 2-FTP, 3-SCP) [1]:
User Name: userfoo
File Name: /home/userfoo/v6.4.0
Password: <hidden>
Do Auto-Commit after Reboot [Y]: n
Reboot system after download [N]: y
Firmware is being downloaded to the switch. This step may take up to 30
minutes.
Checking system settings for firmwaredownload...
```

The switch will perform a reboot and come up with the new firmware to be tested. Your current switch session will automatically disconnect.

7. Connect to the switch, log in as admin, and enter the **firmwareShow** command to confirm that the primary partition of the switch contains the new firmware.

You are now ready to evaluate the new version of firmware.

---

**ATTENTION**

**Stop!** If you want to *restore* the firmware, stop here and skip ahead to [step 9](#); otherwise, continue to [step 8](#) to commit the firmware on the switch, which completes the firmware download operations.

---

8. Commit the firmware.
  - a. Enter the **firmwareCommit** command to update the secondary partition with new firmware. Note that it takes several minutes to complete the commit operation.
  - b. Enter the **firmwareShow** command to confirm both partitions on the switch contain the new firmware.

---

**ATTENTION**

**Stop!** If you have completed [step 8](#), then you have committed the firmware on the switch and you have completed the firmware download procedure.

---

9. Restore the firmware.
  - a. Enter the **firmwareRestore** command. The switch will reboot and come up with the original firmware again.

A **firmwareCommit** will automatically begin to copy the original firmware from the primary partition to the secondary partition. At the end of the firmware commit process, both partitions will have the original firmware. Note that it takes several minutes to complete the commit operation.
  - b. Wait five minutes to ensure that all processes have completed and the switch is fully up and operational.
  - c. Log in to the switch. Enter the **firmwareShow** command and verify that both partitions on the switch have the original firmware.

## Test and restore firmware on enterprise-class platforms

This procedure enables you to perform a firmware download on each CP and verify that the procedure was successful before committing to the new firmware. The old firmware is saved in the secondary partition of each CP until you enter the **firmwareCommit** command. If you decide to back out of the installation prior to the **firmwareCommit**, you can enter the **firmwareRestore** command to restore the former active Fabric OS firmware image.

The **firmwareRestore** command can only run if autocommit was disabled during the **firmwareDownload**. This command cannot be used to restore SAS and SA images.

---

**NOTE**

Brocade recommends that, under normal operating conditions, you maintain the same firmware version on both CPs, and on both partitions of each CP. This procedure enables you to evaluate firmware before you commit. As a standard practice, you should not run mixed firmware levels on CPs.

---

## Testing different firmware versions on enterprise-class platforms

1. Connect to the Brocade enterprise-class platform IP address.
2. Enter the **ipAddrShow** command and note the address of CP0 and CP1.
3. Enter the **haShow** command and note which CP is active and which CP is standby. Verify that both CPs are in sync.
4. Enter the **firmwareShow** command and confirm that the current firmware on both partitions on both CPs is listed as expected.
5. Exit the session.
6. Update the firmware on the standby CP.
  - a. Connect to the enterprise-class platform and log in as admin to the standby CP.
  - b. Enter the **firmwareDownload -s** command and respond to the prompts.  
  
At this point, the firmware should download to the standby CP only. When it has completed the download to that CP, reboot it. The current enterprise-class platform session will be disconnected.
7. Fail over to the standby CP.
  - a. Connect to the enterprise-class platform on the active CP.
  - b. Enter the **haShow** command to verify that HA synchronization is complete. It will take a minute or two for the standby CP to reboot and synchronize with the active CP.



### CAUTION

If you are downgrading from Fabric OS v6.2.0 to v6.1.0, your CPs will not gain synchronization and this will be a disruptive firmware download. Refer to [Table 44](#) on page 191 for more information on synchronization states.

- c. Enter the **firmwareShow** command to confirm that the primary partition of the standby CP contains the new firmware.
- d. Enter the **haFailover** command. The active CP will reboot and the current enterprise-class platform session will be disconnected.  
  
**If an AP blade is present:** At the point of the failover an *autoleveling* process is activated. See, "[Enterprise-class platform firmware download process overview](#)" on page 196 for details about autoleveling.
8. Verify the failover.
  - a. Connect to the enterprise-class platform on the active CP, which is the former standby CP.
  - b. Enter the **haShow** command to verify that the HA synchronization is complete. It will take a minute or two for the standby CP, which is the old active CP, to reboot and synchronize with the active CP.

### NOTE

If the CPs fail to synchronize, you can still proceed because the version being tested is already present on the active CP, and subsequent steps will ensure that the standby CP is updated to the same version as the active CP.

- c. Confirm the evaluation version of firmware is now running on the active CP by entering the **firmwareShow** command.
9. Update firmware on the standby CP.
    - a. Connect to the enterprise-class platform on the standby CP, which is the old active CP.
    - b. Enter the **firmwareDownload** command with the **-s -b -n** operands. This ensures that the following steps are successful.

At this point the firmware should download to the standby CP only and reboot it. The current enterprise-class platform session will be disconnected.
    - c. Wait one minute for the standby CP to reboot, and then connect to the enterprise-class platform and log in as admin.
    - d. Enter the **firmwareShow** command to confirm that *both* primary partitions now have the test drive firmware in place.

You are now ready to evaluate the new version of firmware.

---

**ATTENTION**

**Stop!** If you want to *restore* the firmware, stop here and skip ahead to [step 12](#); otherwise, continue to [step 10](#) to commit the firmware on both CPs, which completes the firmware download.

---

10. Perform a commit on the standby CP.

From the current enterprise-class platform session on the standby CP, enter the **firmwareCommit** command to update the secondary partition with new firmware. It takes several minutes to complete the commit operation. Do not do anything on the enterprise-class platform while this operation is in process.
11. Perform a commit on the active CP.
  - a. From the current enterprise-class platform session on the active CP, enter the **firmwareShow** command and confirm that only the active CP secondary partition contains the old firmware.
  - b. Enter the **firmwareCommit** command to update the secondary partition with the new firmware. It takes several minutes to complete the commit operation. Do not do anything on the enterprise-class platform while this operation is in process.
  - c. Upon completion of the **firmwareCommit** command, type the **firmwareShow** command to confirm both partitions on both CPs contain the new firmware.
  - d. Enter the **haShow** command to confirm that the HA state is in sync.

---

**ATTENTION**

**Stop!** If you have completed [step 11](#), then you have committed the firmware on both CPs and you have completed the firmware download procedure.

---

12. Restore the firmware on the standby CP.

In the current enterprise-class platform session for the standby CP, enter the **firmwareRestore** command. The standby CP will reboot and the current enterprise-class platform session will end. Both partitions will have the same Fabric OS after several minutes.
13. Perform **haFailover** on the active CP.

- a. In the current enterprise-class platform session for the active CP, enter the **haShow** command to verify that HA synchronization is complete. It will take a minute or two for the standby CP to reboot and synchronize with the active CP.
  - b. Enter the **haFailover** command. The active CP will reboot and the current enterprise-class platform session will end. The enterprise-class platform is now running the original firmware.
14. Restore firmware on the “new” standby CP.
- a. Wait one minute and connect to the enterprise-class platform on the new standby CP, which is the old active CP.
  - b. Enter the **firmwareRestore** command. The standby CP will reboot and the current enterprise-class platform session will end. Both partitions will have the same Fabric OS after several minutes.
  - c. Wait five minutes and log in to the enterprise-class platform. Enter the **firmwareShow** command and verify that all partitions have the original firmware.

**If an AP blade is present:** Blade partitions always contain the same version of the firmware on both partitions (it does not keep two copies). The firmware is stored on the blade’s compact flash card and is always synchronized with the active CP’s firmware. Thus, if you restore the active CP firmware, the blade firmware is automatically downloaded (auto-leveled) to become consistent with the new CP firmware (the blade firmware is basically restored).

Your system is now restored to the original partitions on both CPs. Make sure that servers using the fabric can access their storage devices.

If you want to upgrade an enterprise-class platform with only one CP in it, follow the procedures in [“Test and restore firmware on switches”](#) on page 203. Note, however, that upgrading an enterprise-class platform with only one CP will be disruptive to switch traffic.

## Validating a firmware download

Validate the firmware download by running the following commands: **firmwareShow**, **firmwareDownloadStatus**, **nsShow**, **nsAllShow**, and **fabricShow**.

---

### NOTE

When you prepared for the firmware download earlier, you issued either the **supportShow** or **supportSave** command. Although you can issue the command again and compare the output from before and after, it may take up to 30 minutes for the command to execute. To save time, it is recommended that you use the commands listed below, which are all subsets of the **supportSave** output.

---

All of the connected servers, storage, and switches should be present in the output of these commands. If there is a discrepancy, it is possible that a device or switch cannot connect to the fabric and further troubleshooting is necessary.

<b>firmwareShow</b>	Displays the current firmware level on the switch. For Brocade directors, this command displays the firmware loaded on both partitions (primary and secondary) for both CPs and AP blades. Brocade recommends that you maintain the same firmware level on both partitions of each CP within the Brocade director. The <b>firmwareShow</b> command will display the firmware version on the CPs.
---------------------	--

## 9 Validating a firmware download

```
ecp:admin> firmwreshow
```

Slot Name	Appl	Primary/Secondary Versions	Status
6 CP0	FOS	v6.4.0 v6.4.0	ACTIVE *
7 CP1	FOS	v6.4.0 v6.4.0	STANDBY
* Local CP			

**firmwareDownloadStatus** Displays an event log that records the progress and status of events during Fabric OS, SAS, and SA firmwareDownload. The event log is created by the current firmwareDownload command and is kept until another firmwareDownload command is issued. There is a timestamp associated with each event. When downloading SAS or SA in systems with two control processor (CP) cards, you can only run this command on the active CP. When downloading Fabric OS, the event logs in the two CPs are synchronized. This command can be run from either CP.

**nsShow** Displays all devices directly connected to the switch that have logged into the name server. Make sure the number of attached devices after the firmware download is exactly the same as the number of attached devices prior to the firmware download.

**nsAllShow** Displays all devices connected to a fabric. Make sure the number of attached devices after the firmware download is exactly the same as the number of attached devices prior to the firmware download.

**fabricShow** Displays all switches in a fabric. Make sure the number of switches in the fabric after the firmware download is exactly the same as the number of attached devices prior to the firmware download.



# Managing Virtual Fabrics

---

## In this chapter

• Virtual Fabrics overview . . . . .	209
• Logical switch overview . . . . .	210
• Logical fabric overview . . . . .	214
• Management model for logical switches . . . . .	219
• Account management and Virtual Fabrics . . . . .	220
• Supported platforms for Virtual Fabrics . . . . .	220
• Limitations and restrictions of Virtual Fabrics . . . . .	222
• Enabling Virtual Fabrics mode . . . . .	223
• Disabling Virtual Fabrics mode . . . . .	224
• Configuring logical switches to use basic configuration values . . . . .	225
• Creating a logical switch or base switch . . . . .	225
• Executing a command in a different logical fabric context . . . . .	227
• Deleting a logical switch . . . . .	228
• Adding and removing ports on a logical switch . . . . .	229
• Displaying logical switch configuration . . . . .	230
• Changing the fabric ID of a logical switch . . . . .	230
• Changing a logical switch to a base switch . . . . .	231
• Configuring a logical switch to use XISLs . . . . .	232
• Changing the context to a different logical fabric . . . . .	233
• Creating a logical fabric using XISLs . . . . .	234

## Virtual Fabrics overview

Virtual Fabrics is an architecture to virtualize hardware boundaries. Traditionally, SAN design and management is done at the granularity of a physical switch. The Virtual Fabrics feature allows SAN design and management to be done at the granularity of a port.

Virtual Fabrics is a suite of related features that can be customized based on your needs. The Virtual Fabrics suite consists of the following specific features:

- Logical switch
- Logical fabric
- Device sharing

This chapter describes the logical switch and logical fabric features. For information about device sharing with Virtual Fabrics, see [“FC-FC Routing and Virtual Fabrics”](#) on page 492.

The following platforms are Virtual Fabrics-capable:

- Brocade DCX and DCX-4S
- Brocade 5300
- Brocade 5100
- Brocade VA-40FC

On the Brocade VA-40FC, Virtual Fabrics is supported only in Native mode

For additional information about supported switches and port types, see [“Supported platforms for Virtual Fabrics”](#) on page 220.

Virtual Fabrics and Admin Domains are mutually exclusive and are not supported at the same time on a switch.

---

**NOTE**

A note on terminology: *Virtual Fabrics* is the name of the feature. A *logical fabric* is a type of fabric that you can create using the Virtual Fabrics feature.

---

## Logical switch overview

Traditionally, each switch and all the ports in the switch act as a single Fibre Channel switch (FC switch) that participates in a single fabric. The logical switch feature allows you to divide a physical chassis into multiple fabric elements. Each of these fabric elements is referred to as a *logical switch*. Each logical switch functions as an independent self-contained FC switch.

---

**NOTE**

Each chassis can have multiple logical switches.

---

### Default logical switch

To use the Virtual Fabrics features, you must first enable Virtual Fabrics on the switch. [Figure 20](#) on page 211 shows a switch before and after enabling Virtual Fabrics. The switch must be Virtual Fabrics-capable (Brocade DCX, DCX-4S, 5300, 5100, or VA-40FC). Enabling Virtual Fabrics creates a single logical switch in the physical chassis. This logical switch is called the *default logical switch*, and it initially contains all of the ports in the physical chassis. In this example, the switch has 10 ports, labeled P0 through P9.

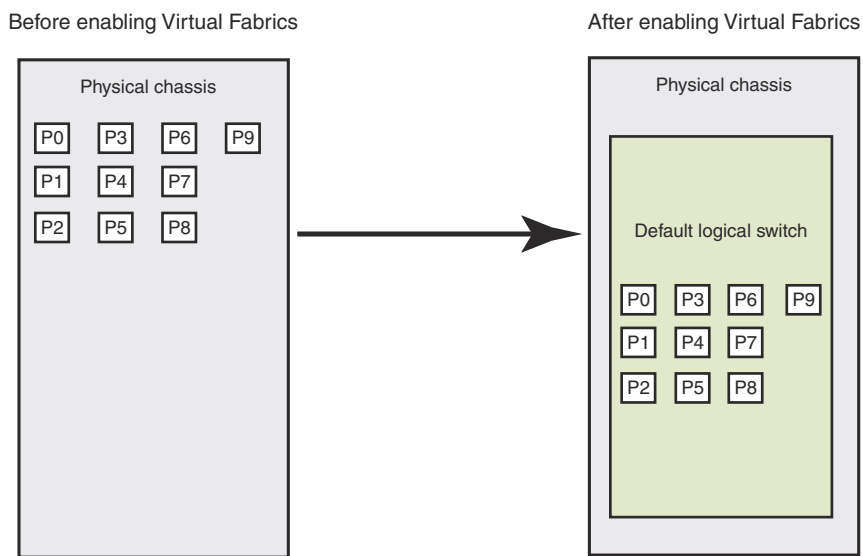

FIGURE 20 Switch before and after enabling Virtual Fabrics

After you enable Virtual Fabrics, you can create up to eight logical switches, depending on the switch model.

Figure 21 shows a Virtual Fabrics-enabled switch before and after it is divided into logical switches. Before you create logical switches, the chassis appears as a single switch (default logical switch). After you create logical switches, the chassis appears as multiple independent logical switches. All of the ports continue to belong to the default logical switch until you explicitly move them to other logical switches.

The default logical switch always exists. You can add and delete other logical switches, but you cannot delete the default logical switch unless you disable Virtual Fabrics.

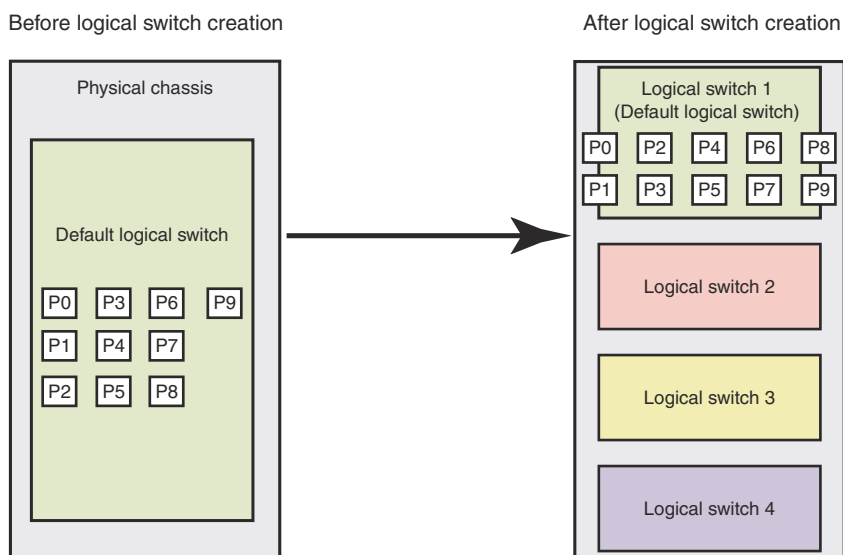

FIGURE 21 Switch before and after creating logical switches

## Logical switches and fabric IDs

When you create a logical switch, you must assign it a fabric ID (FID). The fabric ID uniquely identifies each logical switch within a chassis and indicates to which fabric the logical switch belongs. You cannot define multiple logical switches with the same fabric ID within the chassis.

In [Figure 22](#), logical switches 2, 3, 4, and 5 are assigned FIDs of 1, 15, 8, and 20, respectively. These logical switches belong to different fabrics, even though they are in the same physical chassis. For example, you could not assign logical switch 5 a fabric ID of 15, because logical switch 3 is already assigned FID 15 in the chassis. Each logical switch must have a unique fabric ID within the chassis.

The default logical switch is initially assigned FID 128. You can change this value later.

---

### NOTE

Each logical switch is assigned one and only one FID. The FID identifies the logical fabric to which the logical switch belongs.

---

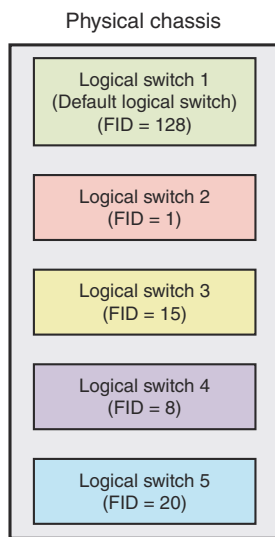
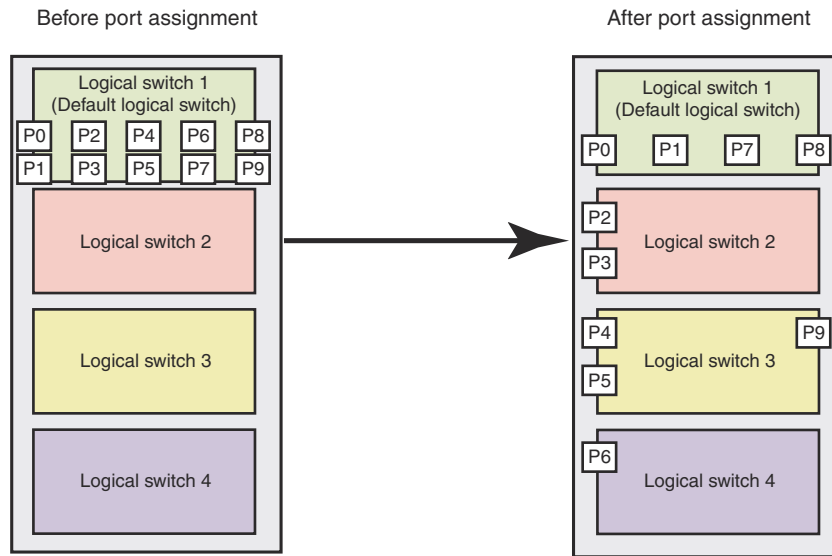

**FIGURE 22** Fabric IDs assigned to logical switches

## Port assignment in logical switches

Initially, all ports belong to the default logical switch. When you create additional logical switches, they are empty and you must assign ports to those logical switches. As you assign ports to a logical switch, the ports are moved from the default logical switch to the newly created logical switch. A given port can be in only one logical switch.

In [Figure 23](#) on page 213, the default logical switch initially has 10 ports, labeled P0 through P9. After logical switches are created, the ports are assigned to specific logical switches. Note that ports 0, 1, 7, and 8 have not been assigned to a logical switch and so remain assigned to the default logical switch.



**FIGURE 23** Assigning ports to logical switches

A given port is always in one (and only one) logical switch. The following scenarios refer to the chassis after port assignment in [Figure 23](#).

- If you assign P2 to Logical switch 2, you cannot assign P2 to any other logical switch.
- If you want to remove a port from a logical switch, you must move it to a different logical switch. For example, if you want to remove P4 from Logical switch 3, you must assign it to a different logical switch, either Logical switch 2, Logical switch 4, or Logical switch 1 (the default logical switch).
- If you assign a port to a logical switch, it is automatically removed from the logical switch it is currently in. If you assign P3 to Logical switch 3, P3 is automatically removed from Logical switch 2.
- If you do not assign a port to any logical switch, it remains in the default logical switch, as is the case with ports 0, 1, 7, and 8.

See [“Adding and removing ports on a logical switch”](#) on page 229 for instructions for assigning and moving ports on logical switches.

A logical switch can have as many ports as are available in the chassis. In [Figure 23](#), the chassis has 10 ports. You could assign all 10 ports to a single logical switch, such as Logical switch 2; if you did this, however, then no ports would be available for Logical switches 3 and 4.

You can move only F\_Ports and E\_Ports from one logical switch to another. If you want to configure a different type of port, such as a VE\_Port or EX\_Port, you must configure them after you move them. Some types of ports cannot be moved from the default logical switch. See [“Supported platforms for Virtual Fabrics”](#) on page 220 for detailed information about these ports.

## Logical switches and connected devices

You can connect devices to logical switches, as shown in [Figure 24](#) on page 214. In Logical switch 2, P2 is an F\_Port that is connected to H1. In Logical switch 3, P4 is an F\_Port that is connected to D1. H1 and D1 cannot communicate with each other because they are in different fabrics, even though they are both connected to the same physical chassis.

You can also connect other switches to logical switches. In [Figure 24](#), P6 is an E\_Port that forms an ISL between Logical switch 4 and the non-Virtual Fabrics switch. Logical switch 4 is the only logical switch that can communicate with the non-Virtual Fabrics switch and D2, because the other logical switches are in different fabrics.

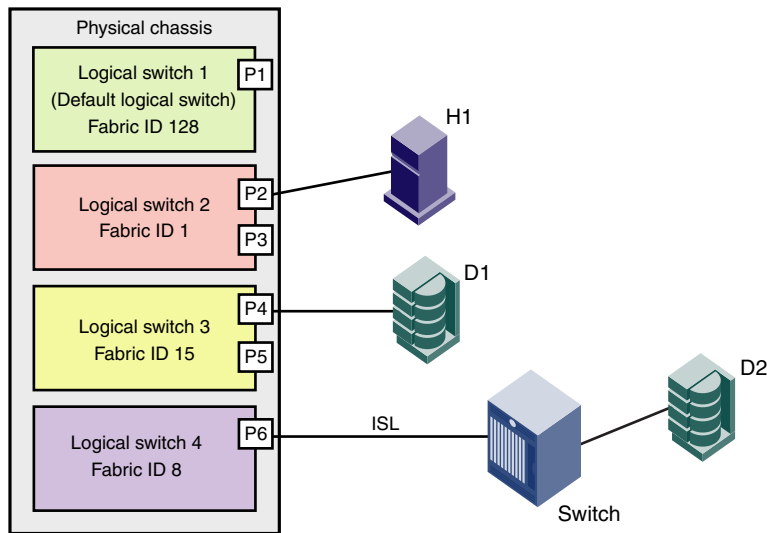

FIGURE 24 Logical switches connected to devices and non-Virtual Fabric switch

[Figure 25](#) shows a logical representation of the physical chassis and devices in [Figure 24](#). As shown in [Figure 25](#), the devices are isolated into separate fabrics.

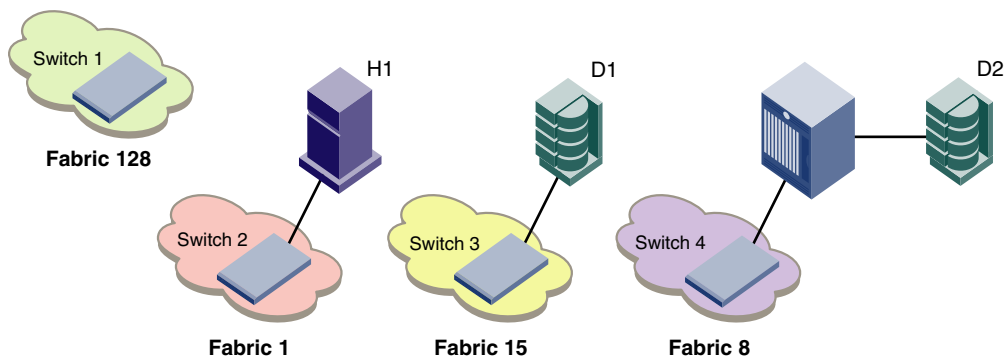

FIGURE 25 Logical switches in a single chassis belong to separate fabrics

If you want to allow device sharing across fabrics in a Virtual Fabrics environment, see [“FC-FC Routing and Virtual Fabrics”](#) on page 492.

## Logical fabric overview

A *logical fabric* is a fabric that contains at least one logical switch. The four fabrics shown in [Figure 24](#) and [Figure 25](#) are logical fabrics because they each have at least one logical switch.

You can connect logical switches to non-Virtual Fabric switches and to other logical switches.

You connect logical switches to non-Virtual Fabric switches using an ISL, as shown in [Figure 24](#).

You connect logical switches to other logical switches in two ways:

- Using ISLs
- Using base switches and shared ISLs

## Logical fabric and ISLs

Figure 26 shows two physical chassis divided into logical switches.

In Figure 26, ISLs are used to connect the logical switches with fabric ID 1 and the logical switches with fabric ID 15. The logical switches with fabric ID 8 are each connected to a non-Virtual Fabrics switch. The two logical switches and the non-Virtual Fabrics switch are all in the same fabric, with fabric ID 8.

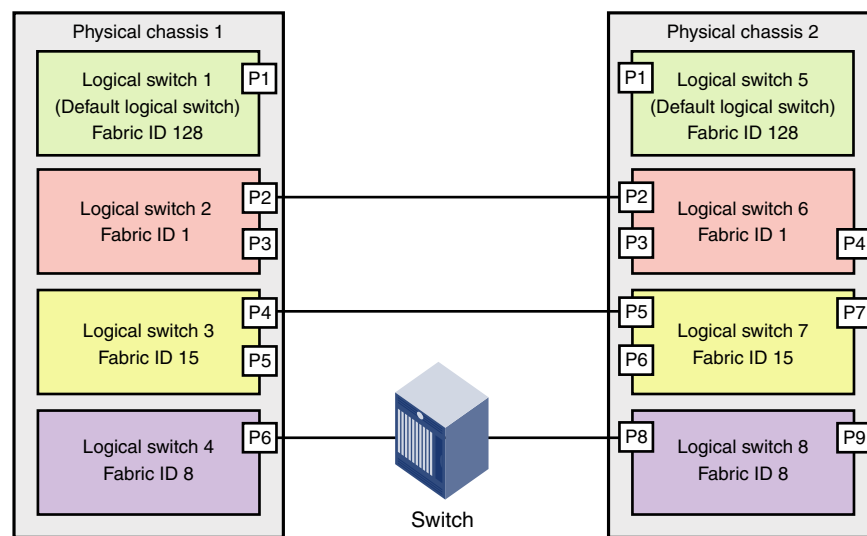

FIGURE 26 Logical switches connected to other logical switches through physical ISLs

Figure 27 shows a logical representation of the configuration in Figure 26.

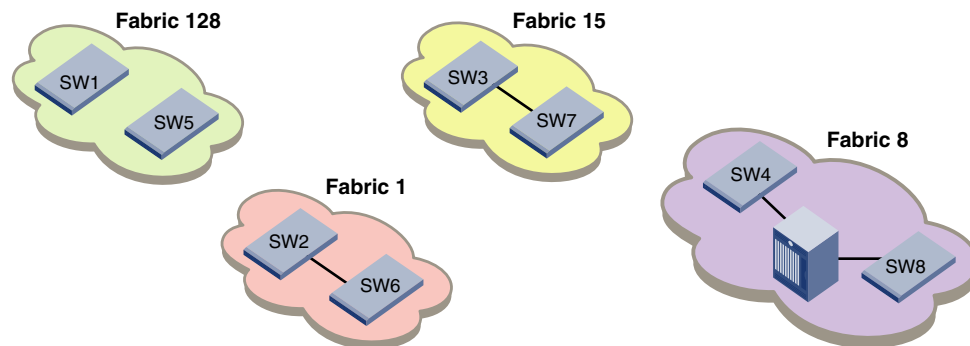

FIGURE 27 Logical switches connected to form logical fabrics

The ISLs between the logical switches are *dedicated ISLs* because they carry traffic only for a single logical fabric. In Figure 26, Fabric 128 has two switches (the default logical switches), but they cannot communicate with each other because they have no ISLs between them and they cannot use the ISLs between the other logical switches.

**NOTE**

Only logical switches with the same FID can form a fabric. If you connect two logical switches with different FIDs, the link between the switches segments.

## Logical fabric and ISL sharing

Another way to connect logical switches is using extended ISLs and base switches.

When you divide a chassis into logical switches, you can designate one of the switches to be a base switch. A *base switch* is a special logical switch that is used for interconnecting the physical chassis. A base switch has the following properties:

- ISLs connected through the base switch can be used for communication among the other logical switches.
- Base switches do not support direct device connectivity. A base switch can have only E\_Ports, VE\_Ports, EX\_Ports, or VEX\_Ports, but no F\_Ports.
- The base switch provides a common address space for communication between different logical fabrics.
- A base switch can be configured for the preferred domain ID just like a non-Virtual Fabrics switch.
- You can have only one base switch in a physical chassis.

A base switch can be connected to other base switches through a special ISL, called a *shared ISL* or *extended ISL* (XISL). An extended ISL is an ISL that connects base switches. The XISL is used to share traffic among different logical fabrics.

Fabric formation across an XISL is based on the FIDs of the logical switches.

Figure 28 shows two physical chassis divided into logical switches. Each chassis has one base switch. An ISL connects the two base switches. This ISL is an extended ISL (XISL) because it connects base switches.

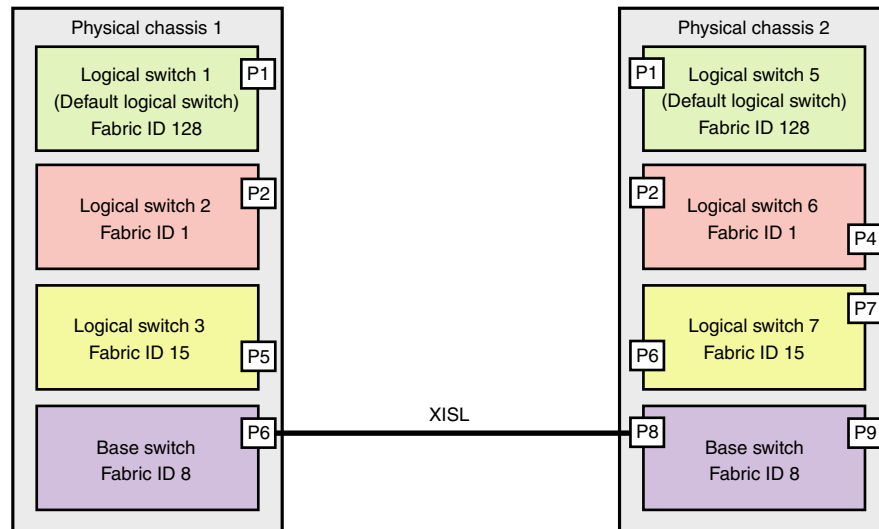
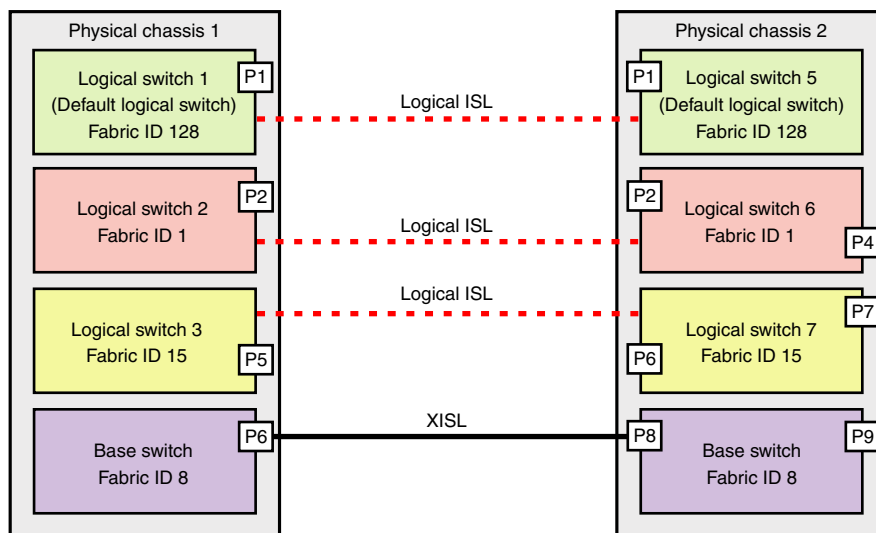

FIGURE 28 Base switches connected by an XISL



Traffic between the logical switches can now flow across this XISL. The traffic can flow only between logical switches with the same fabric ID. For example, traffic can flow between Logical Switch 2 in chassis 1 and Logical switch 6 in chassis 2, because they both have fabric ID 1. Traffic cannot flow between Logical switch 2 and Logical switch 7, because they have different fabric IDs (and are thus in different fabrics).

Think of the logical switches as being connected with logical ISLs, as shown in Figure 29. In this diagram, the logical ISLs are not connected to ports because they are not physical cables. They are just a logical representation of the switch connections that are allowed by the XISL.



**FIGURE 29** Logical ISLs connecting logical switches

To be able to use the XISL, the logical switches must be configured to allow XISL use. By default, they are configured to do so; you can change this setting, however, using the procedure described in “Configuring a logical switch to use XISLs” on page 232.

**NOTE**

The default logical switch in the Brocade DCX or DCX-4S cannot use XISLs.

You can also connect logical switches using a combination of ISLs and XISLs, as shown in Figure 30 on page 218. In this diagram, traffic between the logical switches in fabric 1 can travel over either the ISL or the XISL. Traffic between the other logical switches travels only over the XISL.

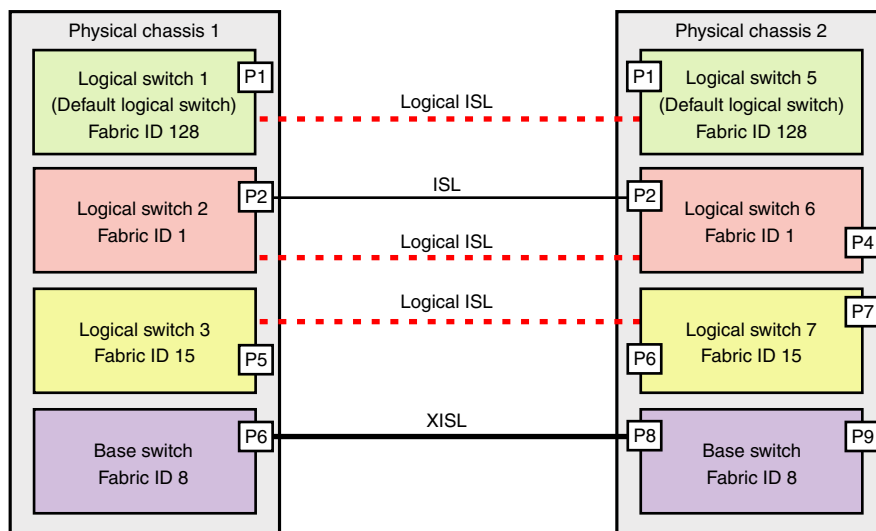

FIGURE 30 Logical fabric using ISLs and XISLs

By default, the physical ISL path is favored over the logical path (over the XISL) because the physical path has a lower cost. This behavior can be changed by configuring the cost of the dedicated physical ISL to match the cost of the LISL.

Base switch ports on different chassis can be connected together to form a fabric, called a *base fabric*. Similar to other logical switches, the base switches must have the same FID to be connected. If the base switches have different fabric IDs, the link between the switches is disabled.

It is a good practice to configure at least two XISLs, for redundancy.

The base fabric follows normal routing policies. As long as physical connectivity is available, the base fabric maintains connectivity for the logical fabrics.

**NOTE**

If you disable a base switch, all of the logical ISLs are broken and the logical switches cannot communicate with each other unless they are connected by a physical ISL.

**Logical ports**

As shown in Figure 30, logical ISLs are formed to connect logical switches. A *logical port* represents the ports at each end of a logical ISL. A logical port is a software construct only and does not correspond to any physical port.

Most port commands are not supported on logical ports. For example, you cannot change the state or configuration of a logical port.

The WWN for logical ports is in NAA=5 format, using the following syntax:

5n:nn:nn:nz:zz:zz:zx:xx

where:

nnnnnn is the Brocade Organizationally Unique Identifier (OUI).

zzzzzz is the logical fabric serial number.

xxx is the logical port number, in the range 0–FFF.

### *Logical fabric formation*

Fabric formation is not based on connectivity, but is based on the FIDs of the logical switches. The basic order of fabric formation is as follows:

1. Base fabric forms.
2. Logical fabrics form when the base fabric is stable.
3. Traffic is initiated between the logical switches.
4. Devices start seeing each other.

## Management model for logical switches

You can use one common IP address for the hardware that is shared by all of the logical switches in the chassis and you can set up individual IPv4 addresses for each Virtual Fabric. For a management host to manage a logical switch using the IPFC IP address, it must be physically connected to the Virtual Fabric using an HBA.

All user operations are classified into one of the following:

- Chassis management operations

These are operations that span logical switch boundaries, such as:

- Logical switch configuration (creating, deleting, modifying logical switches)
- Account management (determining which accounts can access which logical switches)
- FRU management (**slotShow**)
- Firmware management (one firmware applies to all logical switches, firmware upgrade, HA failover)

- Logical switch operations

These are operations that are limited to the logical switch, such as displaying or changing port states. Logical switch operations include all operations that are not covered in the chassis management operations.

When a user logs in, the user is assigned an active context, or active logical switch. This context filters the view that the user gets, and determines which ports the user can see. You can change the active context. For example, if you are working with logical switch 1, you can change the context to logical switch 5. When you change the context to logical switch 5, you only see the ports that are assigned to that logical switch. You do not see any of the other ports in the chassis.

The scope of logical switch operations is defined by the active context. When you are in the context of a logical switch, you can perform port, switch, and fabric-level operations, subject to RBAC rules.

If you have permission to execute chassis-level commands, you can do so, regardless of which logical switch context you are in.

## Account management and Virtual Fabrics

When user accounts are created, they are assigned a list of logical fabrics to which they can log in and a home logical fabric (home FID). When you connect to a physical chassis, the home FID defines the logical switch to which you are logged in by default. You can change to a different logical switch context, as described in [“Changing the context to a different logical fabric”](#) on page 233.

When you are logged in to a logical switch, the system prompt changes to display the FID of that switch. The following are example prompts for when you are logged in to the default logical switch (FID = 128) and a user-defined logical switch (with FID = 15):

```
switch:FID128:admin>  
switch:FID15:admin>
```

See [“Managing User Accounts”](#) on page 83 for information about creating user accounts and assigning FIDs to user accounts.

## Supported platforms for Virtual Fabrics

Virtual Fabrics is supported on the following platforms:

- Brocade 5100
- Brocade 5300
- Brocade VA-40FC, in Native mode only
- Brocade DCX
- Brocade DCX-4S

Some restrictions apply to the ports, depending on the port type and blade type. The following sections explain these restrictions.

### Supported port configurations in the Brocade 5100, 5300, and VA-40FC

There are no restrictions on the ports in the Brocade 5100, 5300, and VA-40FC; however, the following rules apply:

- Any port can belong to any logical switch (including the base and default logical switches), with the exception that F\_Ports cannot belong to the base switch.
- The default logical switch can use XISLs.
- The default logical switch can also be a base logical switch.

## Supported port configurations in the Brocade DCX and DCX-4S

Some of the ports in the Brocade DCX and DCX-4S are not supported on all types of logical switches. [Table 45](#) on page 221 lists the blades and ports that are supported on each type of logical switch.

**TABLE 45** Blade and port types supported on logical switches

Blade type	Default logical switch	User-defined logical switch	Base switch
FC8-16 FC8-32 FC8-48	Yes (F, E)	Yes (F, E)	Yes (E, EX)
FC8-64	Yes (F, E) <sup>1</sup>	Yes (F, E)	Yes (E, EX) <sup>2</sup>
FA4-18	Yes (F, E, VE)	No	No
FC10-6	Yes (F, E)	No	No
FS8-18	Yes (F, E)	No	No
FCOE10-24	Yes (F, E)	No	No
FX8-24			
FC ports	Yes (F, E)	Yes (F, E,)	Yes (E, EX)
GE ports	Yes (VE)	Yes (VE)	Yes (VE, VEX)
FR4-18i			
FC ports	Yes (F, E)	No	No
GE ports	Yes (VE)	Yes (VE)	Yes (VE, VEX)
ICL ports	Yes	Yes	Yes

1. In the Brocade DCX, ports 56–63 of the FC8-64 blade are not supported as E\_Ports on the default logical switch. The Brocade DCX-4S does not have this limitation.
2. In the Brocade DCX, ports 48–63 of the FC8-64 blade are not supported in the base switch. The Brocade DCX-4S does not have this limitation.

The following restrictions apply:

- EX\_Ports and VEX\_Ports can be in only the base switch.
- VE\_Ports are supported on the base switch only for carrying FCR traffic to VEX\_Ports. VE\_Ports in the base switch are not supported for carrying logical fabric traffic over XISLs.
- VE\_Ports cannot be in a logical switch that is using XISLs.
- ICL ports cannot be in a logical switch that is using XISLs.
- The default logical switch cannot use XISLs.
- The default logical switch cannot be designated as the base switch.

## Virtual Fabrics interaction with other Fabric OS features

[Table 46](#) lists some of the Fabric OS features and considerations that apply when using Virtual Fabrics.

**TABLE 46** Virtual Fabrics interaction with Fabric OS features

Fabric OS feature	Virtual Fabrics interaction
Admin Domains	Virtual Fabrics and Admin Domains are mutually exclusive and are not supported at the same time on a switch. To use Admin Domains, you must first disable Virtual Fabrics; to use Virtual Fabrics, you must first delete all Admin Domains. See <a href="#">“Deleting all user-defined Admin Domains non-disruptively”</a> on page 352 for information on deleting Admin Domains without disrupting device-to-device communication.
Configuration upload and download	Virtual Fabrics uses a configuration file that is different from the configuration file used to download system configuration parameters. See <a href="#">Chapter 8, “Maintaining the Switch Configuration File,”</a> for more information about how Virtual Fabrics affects the configuration file.
Encryption	Encryption functionality using the FS8-18 blade is available only on the default logical switch.
FC-FC Routing Service	All EX_Ports must reside in a base switch. You cannot attach EX_Ports to a logical switch that has XISL use enabled. You must use ISLs to connect the logical switches in an edge fabric. Only 8-Gbps ports are allowed to be used as FC router EX_Ports, with the exception of VEX_Ports on the FR4-18i blade. See <a href="#">Chapter 21, “Using the FC-FC Routing Service,”</a> for more information about Virtual Fabrics and FC-FC routing.
FICON	Up to two logical switches per chassis can run FICON Management Server (CUP), but the FICON logical switch must use ISLs and not XISLs.
Interoperability mode	In interoperability modes 2 and 3, you cannot use XISL in the logical fabric. The logical switches must be connected only with ISLs.
Licensing	Licenses are applicable for all logical switches in a chassis.
Performance monitoring	Performance monitors are supported in a limited number of logical switches, depending on the platform type. See <a href="#">Chapter 17, “Monitoring Fabric Performance,”</a> for more information about performance monitoring when Virtual Fabrics are enabled.
QoS	QoS VCs are maintained across the base fabric. See <a href="#">Chapter 18, “Optimizing Fabric Behavior,”</a> for more information about using the Adaptive Networking features with Virtual Fabrics.
Traffic Isolation	Traffic Isolation zones with failover disabled are not supported in logical fabrics. See <a href="#">Chapter 18, “Optimizing Fabric Behavior,”</a> for additional information about using TI Zones with Virtual Fabrics.

## Limitations and restrictions of Virtual Fabrics

The maximum number of logical switches per chassis varies depending on the switch model. [Table 47](#) lists the supported platforms and the maximum number of logical switches (including the default logical switch) supported on each.

**TABLE 47** Maximum number of logical switches per chassis

Platform	Maximum number of logical switches
Brocade DCX	8
Brocade DCX-4S	8
Brocade 5300	4

**TABLE 47** Maximum number of logical switches per chassis (Continued)

Platform	Maximum number of logical switches
Brocade 5100	3
Brocade VA-40FC	3

Following are restrictions on the default logical switch in the Brocade DCX and DCX-4S:

- The default logical switch cannot use extended ISLs (XISLs).
- The default logical switch cannot be a base switch.

Following are restrictions on XISL use. To allow or disallow XISL use for a logical switch, see [“Configuring a logical switch to use XISLs”](#) on page 232. XISL use is not permitted in any of the following scenarios:

- The logical switch is FICON CUP enabled.
- The logical switch is operating in interoperability mode 2 or 3.
- The logical switch has ICL ports.
- The logical switch is an edge switch for an FC router.
- The logical switch is using GbE ports (VE\_Ports).
- The logical switch is the default logical switch in the Brocade DCX or DCX-4S.

## Restrictions on moving ports

The following are restrictions on moving ports among logical switches:

- FC ports cannot be moved if any one of the following features is enabled:
  - Long distance
  - QoS
  - Fport buffers
  - Fport trunking
- Before moving VE\_Ports, you must remove the VE\_Port tunnel configuration.
- VE\_Ports on the FX8-24 blade can be moved to any logical switch independent of the location of the physical GE port.

## Enabling Virtual Fabrics mode

A fabric is said to be in *Virtual Fabrics mode (VF mode)* when the Virtual Fabrics feature is enabled.

Before you can use the Virtual Fabrics features, such as logical switch and logical fabric, you must enable VF mode.

VF mode is disabled by default on switches that you upgrade to Fabric OS 6.2.0 or later. VF mode is enabled by default on a new chassis.

---

### NOTE

When you enable VF mode, the CPs are rebooted and all EX\_Ports are disabled after the reboot.

---

## 10 Disabling Virtual Fabrics mode

1. Connect to the physical chassis and log in using an account assigned to the admin role with the chassis-role permission.
2. Enter the following command to check whether VF mode is enabled:

```
fosconfig --show
```

3. Delete all Admin Domains, as described in [“Deleting all user-defined Admin Domains non-disruptively”](#) on page 352.
4. Enter the following command to enable VF mode:

```
fosconfig --enable vf
```

5. Enter **y** at the prompt.

### Example

The following example checks whether VF mode is enabled or disabled and then enables it.

```
switch:admin> fosconfig --show
FC Routing service:           disabled
iSCSI service:                Service not supported on this Platform
iSNS client service:         Service not supported on this Platform
Virtual Fabric:               disabled
Ethernet Switch Service:     Service not supported on this Platform
```

```
switch:admin> fosconfig --enable vf
WARNING: This is a disruptive operation that requires a reboot to take
effect.
All EX ports will be disabled upon reboot.
Would you like to continue [Y/N] y
VF has been enabled. Your system is being rebooted.
```

## Disabling Virtual Fabrics mode

When you disable VF mode, the following occurs:

- The CPs are rebooted.
- If F\_Port trunking is enabled on ports in the default switch, the F\_Port trunking information is deleted.

If you want to use Admin Domains in a fabric, you must first disable VF mode.

1. Connect to the physical chassis and log in using an account assigned to the admin role with the chassis-role permission.
2. Enter the following command to check whether VF mode is disabled:

```
fosconfig --show
```

3. Delete all of the non-default logical switches, as described in [“Deleting a logical switch”](#) on page 228.
4. Enter the following command to disable VF mode:

```
fosconfig --disable vf
```

5. Enter **y** at the prompt.



**Example**

The following example checks whether VF mode is enabled or disabled and then disables it.

```
switchA:FID128:admin> fosconfig --show
FC Routing service:           disabled
iSCSI service:               Service not supported on this Platform
iSNS client service:         Service not supported on this Platform
Virtual Fabric:              enabled

switch:admin> fosconfig --disable vf
WARNING: This is a disruptive operation that requires a reboot to take
effect.
Would you like to continue [Y/N] y
```

## Configuring logical switches to use basic configuration values

All switches in the fabric are configured to use the same basic configuration values. When you create logical switches, the logical switches might have different configuration values than the default logical switch. Use the following procedure to ensure that newly created logical switches have the same basic configuration values as the default logical switch.

**NOTE**

For most users, you do not need to run this procedure. Contact your switch service provider to determine if you need to use this procedure.

You need to run this procedure only once on each chassis, after you enable Virtual Fabrics but before you create logical switches. The configuration settings are then preserved across reboots and firmware upgrades and downgrades.

1. Connect to the physical chassis and log in using an account assigned to the admin role with the chassis-role permission.
2. Enter the following command to ensure that newly created logical switches have the same basic configuration values as the default logical switch.

```
configurechassis
```

3. Enter **n** at the prompts to configure system and cfgload attributes. Enter **y** at the prompt to configure custom attributes.

```
System (yes, y, no, n): [no] n
cfgload attributes (yes, y, no, n): [no] n
Custom attributes (yes, y, no, n): [no] y
```

4. Enter the appropriate value at the Config Index prompt. Contact your switch service provider to determine the appropriate value.

```
Config Index (0 to ignore): (0..1000) [3]:
```

## Creating a logical switch or base switch

When the logical switch is created, it is automatically enabled and is empty—that is, it does not have any ports. After creating the logical switch, you must disable the switch to configure it and set the domain ID. Then you assign ports to the logical switch.

## 10 Creating a logical switch or base switch

You can optionally define the logical switch to be a base switch. Each chassis can have only one base switch.

---

### NOTE

Domain ID conflicts are detected before fabric ID conflicts. If you have both a domain ID conflict and a fabric ID conflict, only the domain ID conflict is reported.

---

1. Connect to the physical chassis and log in using an account assigned to the admin role with the chassis-role permission.

2. Enter the following command to create a logical switch:

```
lscfg --create fabricID [ -base ] [ -force ]
```

where *fabricID* is the fabric ID that is to be associated with the logical switch.

Specify the **-base** option if the logical switch is to be a base switch.

Specify the **-force** option to execute the command without any user prompts or confirmation.

3. Set the context to the new logical switch.

```
setcontext fabricID
```

where *fabricID* is the fabric ID of the logical switch you just created.

4. Disable the logical switch.

```
switchdisable
```

5. Configure the switch attributes, including assigning a unique domain ID.

```
configure
```

6. Enable the logical switch:

```
switchenable
```

7. Assign ports to the logical switch, as described in [“Adding and removing ports on a logical switch”](#) on page 229.

### Example

The following example creates a logical switch with FID 4, then assigns domain ID 14 to it.

```
sw0:FID128:admin> lscfg --create 4
About to create switch with fid=4. Please wait...
Logical Switch with FID (4) has been successfully created.

Logical Switch has been created with default configurations.
Please configure the Logical Switch with appropriate switch
and protocol settings before activating the Logical Switch.
sw0:FID128:admin> setcontext 4
Please change passwords for switch default accounts now.
Use Control-C to exit or press 'Enter' key to proceed.

Password was not changed. Will prompt again at next login
until password is changed.
switch_4:FID4:admin> switchdisable
switch_4:FID4:admin> configure

Configure...

Fabric parameters (yes, y, no, n): [no] y
```

```

Domain: (1..239) [1] 14
WWN Based persistent PID (yes, y, no, n): [no]
...
(output truncated)

```

WARNING: The domain ID will be changed. The port level zoning may be affected

```
switch_4:FID4:admin> switchenable
```

## Executing a command in a different logical fabric context

This procedure describes how to execute a command for a logical switch while you are in the context of a different logical switch. You can also execute a command for all the logical switches in a chassis.

The command is not executed on those logical switches for which you do not have permission.

1. Connect to the physical chassis and log in using an account assigned to the admin role.
2. Enter one of the following commands:
  - To execute a command in a different logical switch context:

```
fosexec --fid fabricID -c "command"
```
  - To execute the command on all logical switches:

```
fosexec --fid all -c "command"
```

### Example 1: Executing the switchShow command in a different logical switch context

```
sw0:FID128:admin> fosexec --fid 4 -c "switchshow"
```

```
-----
```

"switchshow" on FID 4:

```

switchName:      switch_4
switchType:      66.1
switchState:     Online
switchMode:      Native
switchRole:      Principal
switchDomain:    14
switchId:        fffc0e
switchWwn:       10:00:00:05:1e:82:3c:2b
zoning:          OFF
switchBeacon:    OFF
FC Router:       OFF
Allow XISL Use:  ON
LS Attributes:   [FID: 4, Base Switch: No, Default Switch: No, Address Mode 0]

```

```

Index Port Address Media Speed State      Proto
=====
 22  22   0e1600  --   N8   No_Module  FC  Disabled
 23  23   0e1700  --   N8   No_Module  FC  Disabled

```

### Example 2: Executing the fabricShow command on all logical switches

```
sw0:FID128:admin> fosexec --fid all -c "fabricshow"
```

## 10 Deleting a logical switch

```
-----  
"fabricshow" on FID 128:  
  
Switch ID   Worldwide Name           Enet IP Addr   FC IP Addr     Name  
-----  
97: fffc61 10:00:00:05:1e:82:3c:2a 10.32.79.105   0.0.0.0        >"sw0"  
  
-----  
"fabricshow" on FID 4:  
  
Switch ID   Worldwide Name           Enet IP Addr   FC IP Addr     Name  
-----  
14: fffc0e 10:00:00:05:1e:82:3c:2b 10.32.79.105   0.0.0.0        >"switch_4"  
  
-----  
"fabricshow" on FID 5:  
  
Switch ID   Worldwide Name           Enet IP Addr   FC IP Addr     Name  
-----  
30: fffc1e 10:00:00:05:1e:82:3c:2c 10.32.79.105   0.0.0.0        >"switch_5"
```

## Deleting a logical switch

You must remove all ports from the logical switch before deleting it.

You cannot delete the default logical switch.

---

### NOTE

If you are in the context of the logical switch you want to delete, you are automatically logged out when the fabric ID changes. To avoid being logged out, make sure you are in the context of a different logical switch from the one you are deleting.

---

1. Connect to the physical chassis and log in using an account assigned to the admin role.
2. Remove all ports from the logical switch, as described in ["Adding and removing ports on a logical switch."](#)
3. Enter the following command to delete the logical switch:

```
lscfg --delete fabricID [ -force ]
```

where *fabricID* is the fabric ID of the logical switch to be deleted.

Specify the **-force** option to execute the command without any user prompts or confirmation.

### Example

```
switch_4:FID4:admin> lscfg --delete 7  
All active login sessions for FID 7 have been terminated.  
Switch successfully deleted.
```

## Adding and removing ports on a logical switch

This procedure explains how to add and remove ports on logical switches.

All ports in a chassis must be assigned to a logical switch. All ports are initially assigned to the default logical switch.

When you create a logical switch, it has no ports assigned to it. You add ports to a logical switch by moving the ports from one logical switch to another. See [“Supported platforms for Virtual Fabrics”](#) on page 220 for port restrictions.

If you want to remove a port from a logical switch, you cannot just remove it from the logical switch; you must move the port to a different logical switch.

When you move a port from one logical switch to another, the port is automatically disabled. Any performance monitors that were installed on the port are deleted. If monitors are required in the new logical switch, you must manually reinstall them on the port after the move.

If the logical switch to which the port is moved has fabric mode Top Talkers enabled, then if the port is an E\_Port, fabric mode Top Talker monitors are automatically installed on that port.

---

### NOTE

If you are deploying ICLs in the base switch, then all ports associated with those ICLs must be assigned to the base switch. If you are deploying ICLs to connect to default switches (that is, XISL use is not allowed), then the ICL ports should be assigned (or left) in the default logical switch.

---

1. Connect to the physical chassis and log in using an account assigned to the admin role.
2. Enter the following command to move ports from one logical switch to another:

```
lscfg --config fabricID -slot slot [ -port port ] [ -force ]
```

The ports are assigned to the logical switch specified by *fabricID* and are removed from the logical switch on which they are currently configured.

If the **-port** option is omitted, all ports on the specified slot are assigned to the logical switch.

Specify the **-force** option to execute the command without any user prompts or confirmation.

---

### NOTE

On the Brocade DCX, the **lscfg** command does not allow you to add ports 48–63 of the FC8-64 blade to the base switch. These ports are not supported on the base switch. The Brocade DCX-4S does not have this limitation.

---

3. Enter **y** at the prompt.

The ports are automatically disabled, then removed from their current logical switch and assigned to the logical switch specified by *fabricID*.

### Example

```
sw0:FID128:admin> lscfg --config 5 -port 18-20
This operation requires that the affected ports be disabled.
Would you like to continue [y/n]?: y
Making this configuration change. Please wait...
Configuration change successful.
Please enable your ports/switch when you are ready to continue.
```

## Displaying logical switch configuration

1. Connect to the physical chassis and log in using an account assigned to the admin role with the chassis-role permission.
2. Enter the following command to display a list of all logical switches and the ports assigned to them:

```
lscfg --show [ -provision ]
```

If the **-provision** option is specified, all ports on all slots are displayed, regardless of the slot status.

### Example

```
sw0:FID128:admin> lscfg --show
```

```
Created switches: 128(ds) 4 5
```

Port	0	1	2	3	4	5	6	7	8	9
FID	128	128	128	128	128	128	128	128	128	128
Port	10	11	12	13	14	15	16	17	18	19
FID	128	128	128	128	128	128	128	128	5	5
Port	20	21	22	23	24	25	26	27	28	29
FID	5	128	4	4	128	128	128	128	128	128
Port	30	31	32	33	34	35	36	37	38	39
FID	128	128	128	128	128	128	128	128	128	128

## Changing the fabric ID of a logical switch

The following procedure describes how you can change the fabric ID of an existing logical switch. The fabric ID indicates in which fabric the logical switch participates. By changing the fabric ID, you are moving the logical switch from one fabric to another.

Changing the fabric ID requires permission for chassis management operations. You cannot change the FID of your own logical switch context.

---

### NOTE

If you are in the context of the logical switch whose fabric ID you want to change, you are automatically logged out when the fabric ID changes. To avoid being logged out, make sure you are in the context of a different logical switch from the one whose fabric ID you are changing.

---

1. Connect to the switch and log in using an account assigned to the admin role.
2. Enter the following command to change the fabric ID of a logical switch:

```
lscfg --change fabricID -newfid newFID [ -force ]
```

Specify the **-force** option to execute the command without any user prompts or confirmation.

3. Enable the logical switch.

**Example**

```
sw0:FID128:admin> lscfg --change 5 -newfid 7
Changing of a switch fid requires that the switch be disabled.
Would you like to continue [y/n]?: y
Disabling switch...
All active login sessions for FID 5 have been terminated.
Checking and logging message: fid = 5.
Please enable your switch.
sw0:FID128:admin> fosexec --fid 7 -c "switchenable"

-----

"switchenable" on FID 7:
```

## Changing a logical switch to a base switch

1. Connect to the switch and log in using an account assigned to the admin role with the chassis-role permission.
2. Set the context to the logical switch you want to change, if you are not already in that context.

```
setcontext fabricID
```

where *fabricID* is the fabric ID of the logical switch you want to change to a base switch.

3. Configure the switch to *not* allow XISL use, as described in [“Configuring a logical switch to use XISLs”](#) on page 232.
4. Enter the following command to change the logical switch to a base switch:

```
lscfg --change fabricID -base [ -force ]
```

where *fabricID* is the fabric ID of the logical switch whose attributes you want to change.

Specify the **-force** option to execute the command without any user prompts or confirmation.

5. Enable the switch.

```
switchenable
```

**Example**

```
sw0:FID128:admin> setcontext 7
switch_25:FID7:admin> switchshow
switchName:      switch_25
switchType:      66.1
switchState:     Online
switchMode:      Native
switchRole:      Principal
switchDomain:    30
switchId:        fffc1e
switchWwn:       10:00:00:05:1e:82:3c:2c
zoning:          OFF
switchBeacon:   OFF
FC Router:       OFF
Allow XISL Use:  ON
LS Attributes:   [FID: 7, Base Switch: No, Default Switch: No, Address Mode 0]
```

```
Index Port Address Media Speed State      Proto
=====
18 18 1e1200 -- N8 No_Module FC
```

## 10 Setting up IP addresses for a Virtual Fabric

```
19 19 1e1300 -- N8 No_Module FC
20 20 1e1400 -- N8 No_Module FC
switch_25:FID7:admin> configure
```

Not all options will be available on an enabled switch.  
To disable the switch, use the "switchDisable" command.

Configure...

```
Fabric parameters (yes, y, no, n): [no] y
```

```
WWN Based persistent PID (yes, y, no, n): [no]
```

```
Allow XISL Use (yes, y, no, n): [yes] n
```

```
WARNING!! Disabling this parameter will cause removal of LISLs to  
other logical switches. Do you want to continue? (yes, y, no, n): [no] y
```

```
System services (yes, y, no, n): [no]
```

```
switch_25:FID7:admin> lscfg --change 7 -base
```

Creation of a base switch requires that the proposed new base switch on this system be disabled.

```
Would you like to continue [y/n]?: y
```

```
Disabling the proposed new base switch...
```

```
Disabling switch fid 7
```

```
Please enable your switches when ready.
```

```
switch_25:FID7:admin> switchenable
```

## Setting up IP addresses for a Virtual Fabric

---

### NOTE

IPv6 is not supported when setting the IPFC interface for Virtual Fabrics.

---

1. Connect to the switch and log in using an account assigned to the admin role.
2. Enter the **ipAddrSet -ls** command.
3. Enter the network information in dotted-decimal notation for the Ethernet IPv4 address with a CIDR prefix.

Example of setting an IP address for a logical switch in a Virtual Fabric with an FID of 123 in non-interactive mode with the CIDR prefix:

```
switch:admin> ipaddrset -ls 123 --add 11.1.2.4/24
```

## Removing an IP address for a Virtual Fabric

1. Connect to the switch and log in using an account assigned to the admin role.
2. Enter the **ipAddrSet -ls FID - -delete** command.

```
switch:admin> ipaddrset -ls 123 -delete
```

## Configuring a logical switch to use XISLs

When you create a logical switch, by default it is configured to use XISLs. Use the following procedure to allow or disallow the logical switch to use XISLs in the base fabric.



XISL use is *not* supported for the following cases:

- FICON logical fabrics.
- Logical switches in an edge fabric connected to an FC router.  
If the logical switch is enabled, you cannot allow XISL use. If the logical switch is disabled or has not yet joined the edge fabric, you *can* allow XISL use; however, fabric segmentation occurs when the logical switch is enabled or is connected to an edge fabric.
- Logical switches configured for McDATA Fabric mode (InteropMode 2) or McDATA Open Fabric mode (InteropMode 3)

1. Connect to the physical chassis and log in using an account assigned to the admin role.
2. Set the context to the logical switch you want to manage, if you are not already in that context.

```
setcontext fabricID
```

where *fabricID* is the fabric ID of the logical switch you want to switch to and manage.

3. Enter the **switchShow** command and check the value of the **Allow XISL Use** parameter.
4. Disable the logical switch.

```
switchdisable
```

5. Enter the following command:

```
configure
```

6. Enter **y** after the **Fabric Parameters** prompt:

```
Fabric parameters (yes, y, no, n): [no] y
```

7. Enter **y** at the **Allow XISL Use** prompt to allow XISL use; enter **n** at the prompt to disallow XISL use:

```
Allow XISL Use (yes, y, no, n): y
```

8. Respond to the remaining prompts or press **Ctrl-d** to accept the other settings and exit.
9. Enable the logical switch.

```
switchenable
```

## Changing the context to a different logical fabric

You can change the context to a different logical fabric. Your user account must have permission to access the logical fabric.

1. Connect to the physical chassis and log in using an account assigned to the admin role.
2. Enter the following command to switch to a different logical switch in the chassis:

```
setcontext fabricID
```

where *fabricID* is the fabric ID of the logical switch you want to switch to and manage.

### Example

In this example, notice that the prompt changes when you change to a different logical fabric.

```
sw0:FID128:admin> setcontext 4
switch_4:FID4:admin>
```

## Creating a logical fabric using XISLs

This procedure describes how to create a logical fabric using multiple chassis and XISLs and refers to the configuration shown in [Figure 31](#) as an example.

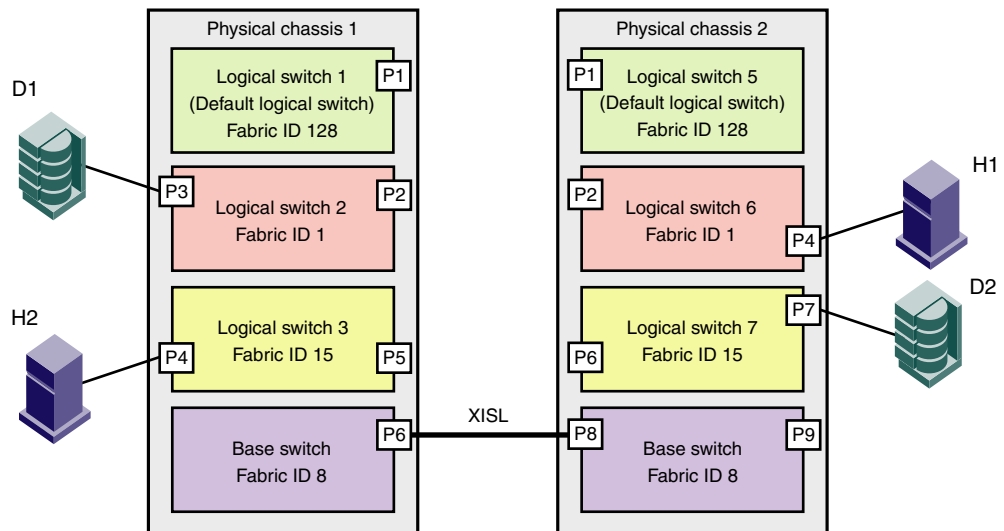

**FIGURE 31** Example of logical fabrics in multiple chassis and XISLs

1. Set up the base switches in each chassis:
  - a. Connect to the physical chassis and log in using an account assigned to the admin role with the chassis-role permission.
  - b. Enable the Virtual Fabrics feature, if it is not already enabled. See [“Enabling Virtual Fabrics mode”](#) on page 223 for instructions.
 

This automatically creates the default logical switch, with FID 128. All ports in the chassis are assigned to the default logical switch.
  - c. Create a base switch and assign it a fabric ID that will become the FID of the base fabric. See [“Creating a logical switch or base switch”](#) on page 225 for instructions on creating a base switch.
 

For the example shown in [Figure 31](#), you would create a base switch with fabric ID 8.
  - d. Assign ports to the base switch, as described in [“Adding and removing ports on a logical switch”](#) on page 229.
  - e. Repeat [step a](#) through [step d](#) in all chassis that are to participate in the logical fabric.
2. Physically connect ports in the base switches to form XISLs.
3. Enable all of the base switches. This forms the base fabric.
4. Configure the logical switches in each chassis:
  - a. Connect to the physical chassis and log in using an account assigned to the admin role with the chassis-role permission.
  - b. Create a logical switch and assign it a fabric ID for the logical fabric. This FID must be different from the FID in the base fabric. See [“Creating a logical switch or base switch”](#) on page 225 for instructions.

For the example shown in [Figure 31](#), you would create a logical switch with FID 1 and a logical switch with FID 15.

- c. Assign ports to the logical switch, as described in [“Adding and removing ports on a logical switch”](#) on page 229.
- d. Physically connect devices and ISLs to these ports on the logical switch.
- e. (Optional) Configure the logical switch to use XISLs, if it is not already XISL-capable. See [“Configuring a logical switch to use XISLs”](#) on page 232 for instructions.

By default, newly created logical switches are configured to allow XISL use.

- f. Repeat [step a](#) through [step e](#) in all chassis that are to participate in the logical fabric, using the same fabric ID whenever two switches need to be part of a single logical fabric.
5. Enable all logical switches by entering the following command on each logical switch that you created in [step 4](#) (the base switches are already enabled):

```
switchenable
```

The logical fabric is formed.

The **fabricShow** command displays all logical switches configured with the same fabric ID as the local switch and all non-Virtual Fabric switches connected through ISLs to these logical switches.

The **switchShow** command displays logical ports as E\_Ports, with -1 for the slot and the user port number for the slot port.

# 10 Creating a logical fabric using XISLs

# Administering Advanced Zoning

---

## In this chapter

- [Special zones](#) . . . . . 237
- [Zoning overview](#) . . . . . 238
- [Broadcast zones](#) . . . . . 244
- [Zone aliases](#) . . . . . 246
- [Zone creation and maintenance](#) . . . . . 249
- [Default zoning mode](#) . . . . . 252
- [Zoning database size](#) . . . . . 253
- [Zoning configurations](#) . . . . . 253
- [Zone object maintenance](#) . . . . . 259
- [Zoning configuration management](#) . . . . . 261
- [Security and zoning](#) . . . . . 263
- [Zone merging scenarios](#) . . . . . 264

## Special zones

Fabric OS has the following types of zones:

- **Zones**  
Enable you to partition your fabric into logical groups of devices that can access each other. These are “regular” or “normal” zones. Unless otherwise specified, all references to zones in this chapter refer to these regular zones.
- **Broadcast zones**  
Control which devices receive broadcast frames. A broadcast zone restricts broadcast packets to only those devices that are members of the broadcast zone. See “[Broadcast zones](#)” on page 244 for more information.
- **Frame redirection zones**  
Re-route frames between an initiator and target through a Virtual Initiator and Virtual Target for special processing or functionality, such as for storage virtualization or encryption. See “[Frame Redirection](#)” on page 81 for more information.
- **LSAN zones**  
Provide device connectivity between fabrics without merging the fabrics. See “[LSAN zone configuration](#)” on page 477 for more information.

- QoS zones  
Assign high or low priority to designated traffic flows. QoS zones are normal zones with additional QoS attributes specified by adding a QoS prefix to the zone name. See [“QoS: SID/DID traffic prioritization”](#) on page 403 for more information.
- Traffic Isolation zones (TI zones)  
Isolate inter-switch traffic to a specific, dedicated path through the fabric. See [“Traffic Isolation Zoning”](#) on page 267 for more information.

## Zoning overview

---

### NOTE

The information in this chapter applies to Brocade Native mode only. For information about zoning in InteropMode 2 or 3, see [Chapter 14, “Interoperability for Merged SANs”](#).

---

Zoning enables you to partition your storage area network (SAN) into logical groups of devices that can access each other. A device can communicate only with other devices connected to the fabric within its specified zone. For example, you can partition your SAN into two zones, *winzzone* and *unixzone*, so that your Windows servers and storage do not interact with your UNIX servers and storage. When zoning is enabled, devices that are not included in a zone configuration are inaccessible to other devices in the fabric.

Zones can be configured dynamically. They can vary in size, depending on the number of fabric-connected devices, and devices can belong to more than one zone. Because zone members can access only other members of the same zone, a device not included in a zone is not available to members of that zone.

When using a mixed fabric—that is, a fabric containing two or more switches running different release levels of fabric operating systems—you should use the switch with the highest Fabric OS level to perform zoning tasks.

You can use zones to logically consolidate equipment for efficiency or to facilitate time-sensitive functions; for example, use zoning to create a temporary zone to back up nonmember devices.

Any zone object connected to the fabric can be included in one or more zones. Zone objects can communicate only with objects within the same zone. For example, consider [Figure 32](#) on page 239, which shows configured zones, Red, Green, and Blue.

- Server 1 can communicate only with the Loop 1 devices.
- Server 2 can communicate only with the RAID and Blue zone devices.
- Server 3 can communicate with the RAID device and the Loop1 device.
- The Loop 2 JBODs are not assigned to a zone; no other zoned fabric device can access them.

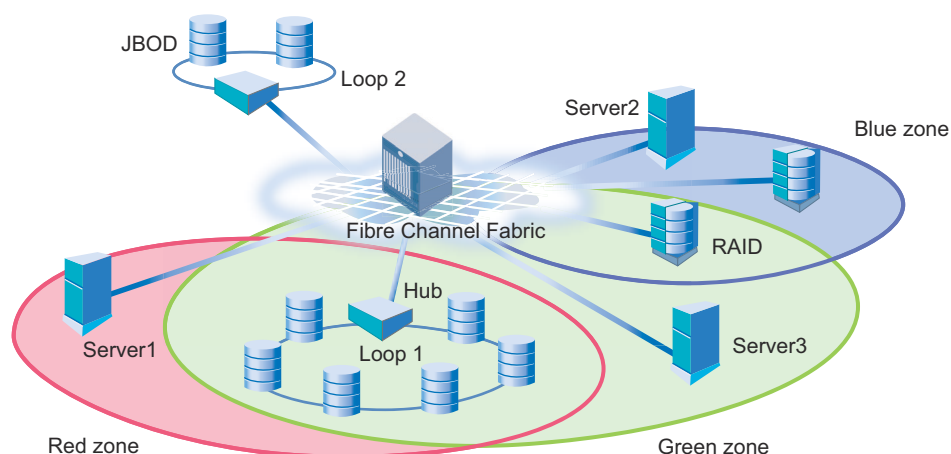

**FIGURE 32** Zoning example

To list the commands associated with zoning, use the **zoneHelp** command. For detailed information on the zoning commands used in the procedures, see the *Fabric OS Command Reference* or the online man page for each command.

## Zone types

Table 48 summarizes the types of zoning available.

**TABLE 48** Types of zoning

Zone type	Description
Storage-based	Storage units typically implement LUN-based zoning, also called <i>LUN masking</i> . LUN-based zoning limits access to the LUNs on the storage port to the specific WWN of the server HBA. It is needed in most SANs. It functions during the probe portion of SCSI initialization. The server probes the storage port for a list of available LUNs and their properties. The storage system compares the WWN of the requesting HBA to the defined zone list, and returns the LUNs assigned to the WWN. Other LUNs on the storage port are not made available to the server.
Host-based	Host-based zoning can implement WWN or LUN masking.
Fabric-based	Fabric switches implement fabric-based zoning, in which the zone members are identified by WWN or port location in the fabric. Fabric-based zoning is also called <i>name server-based</i> or <i>soft zoning</i> . When a device queries the fabric name server, the name server determines the zones in which the device belongs. The server returns information on all members of the zones in the fabric to the device. Devices in the zone are identified by node WWN, port WWN, or <i>domain,port</i> of the switch to which the device is connected. The primary approaches to fabric-based zoning are summarized in Table 49.

Table 49 on page 240 lists the various approaches you can take when implementing zoning in a fabric.

**TABLE 49 Approaches to fabric-based zoning**

Zoning approach	Description
<b>Recommended approach</b>	
Single HBA	Zoning by single HBA most closely re-creates the original SCSI bus. Each zone created has only one HBA (initiator) in the zone; each of the target devices is added to the zone. Typically, a zone is created for the HBA and the disk storage ports are added. If the HBA also accesses tape devices, a second zone is created with the HBA and associated tape devices in it. In the case of clustered systems, it could be appropriate to have an HBA from each of the cluster members included in the zone; this is equivalent to having a shared SCSI bus between the cluster members and assumes that the clustering software can manage access to the shared devices. In a large fabric, zoning by single HBA requires the creation of possibly hundreds of zones; however, each zone contains only a few members. Zone changes affect the smallest possible number of devices, minimizing the impact of an incorrect zone change. This zoning philosophy is the preferred method.
<b>Alternative approaches</b>	
Application	Zoning by application typically requires zoning multiple, perhaps incompatible, operating systems into the same zones. This method of zoning creates the possibility that a minor server in the application suite could disrupt a major server (such as a Web server disrupting a data warehouse server). Zoning by application can also result in a zone with a large number of members, meaning that more notifications, such as registered state change notifications (RSCNs), or errors, go out to a larger group than necessary.
Operating system	Zoning by operating system has issues similar to zoning by application. In a large site, this type of zone can become very large and complex. When zone changes are made, they typically involve applications rather than a particular server type. If members of different operating system clusters can see storage assigned to another cluster, they might attempt to own the other cluster's storage and compromise the stability of the clusters.
Port allocation	Avoid zoning by port allocation unless the administration team has very rigidly enforced processes for port and device allocation in the fabric. It does, however, provide some positive features. For instance, when a storage port, server HBA, or tape drive is replaced, the change of WWN for the new device is of no consequence. As long as the new device is connected to the original port, it continues to have the same access rights. The ports on the edge switches can be pre-associated to storage ports, and control of the fan-in ratio (the ratio of the input port to output port) can be established. With this pre-assigning technique, the administrative team cannot overload any one storage port by associating too many servers with it.
<b>Not recommended</b>	
No fabric zoning	Using no fabric zoning is the least desirable zoning option because it allows devices to have unrestricted access on the fabric. Additionally, any device attached to the fabric, intentionally or maliciously, likewise has unrestricted access to the fabric. This form of zoning should be utilized only in a small and tightly controlled environment, such as when host-based zoning or LUN masking is deployed.

## Zone objects

A *zone object* is any device in a zone, such as:

- Physical port number or port index on the switch
- Node World Wide Name (N-WWN)
- Port World Wide Name (P-WWN)

Zone objects identified by port number or index number are specified as a pair of decimal numbers in the form  $D,I$ , where  $D$  is the domain ID of the switch and  $I$  is the index number on that switch in relation to the port you want to specify.



For example, in enterprise-class platforms, “4,30” specifies port 14 in slot number 2 (domain ID 4, port index 30). On fixed-port models, “3,13” specifies port 13 in switch domain ID 3.

Note the following effects on zone membership based on the type of zone object:

- When a zone object is the physical port number, then all devices connected to that port are in the zone.
- World Wide Names are specified as 8-byte (16-digit) hexadecimal numbers, separated by colons (:) for example, 10:00:00:90:69:00:00:8a.
- When a zone object is the node WWN name, only the specified device is in the zone.
- When a zone object is the port WWN name, only the single port is in the zone.

The types of zone objects used to define a zone can be mixed. For example, a zone defined with the zone objects 2,12; 2,14; 10:00:00:80:33:3f:aa:11 contains the devices connected to domain 2, ports 12 and 14, and a device with the WWN 10:00:00:80:33:3f:aa:11 (either node name or port name) that is connected on the fabric.

## Zoning schemes

You can establish a zone by identifying zone objects using one or more of the following *zoning schemes*:

- Domain,index (D,I)  
All members are specified by *domain ID, port number, or domain, index number pair* or aliases.
- World Wide Name (WWN)  
All members are specified only by World Wide Name (WWNs) or aliases of WWNs. They can be node or port versions of the WWN.
- Mixed zoning  
A zone containing members specified by a combination of *domain,port* or *domain,index* or aliases, and WWNs or aliases of WWNs.

In any scheme, you can identify zone objects using aliases.

## Zone aliases

A *zone alias* is a name assigned to a device or a group of devices. By creating an alias, you can assign a familiar name to a device or group multiple devices into a single name. This simplifies cumbersome data entry and allows an intuitive naming structure (such as using “NT\_Hosts” to define all NT hosts in the fabric).

Zone aliases also simplify repetitive entry of zone objects such as port numbers or a WWN. For example, you can use the name “Eng” as an alias for “10:00:00:80:33:3f:aa:11”.

Naming zones for the initiator they contain can also be useful. For example, if you use the alias SRV\_MAILSERVER\_SLT5 to designate a mail server in PCI slot 5, then the alias for the associated zone is ZNE\_MAILSERVER\_SLT5. This clearly identifies the server host bus adapter (HBA) associated with the zone.

Zone configuration naming is flexible. One configuration should be named *PROD\_fabricname*, where *fabricname* is the name that the fabric has been assigned. The purpose of the *PROD* configuration is to easily identify the configuration that can be implemented and provide the most generic services. If other configurations are used for specialized purposes, names such as “BACKUP\_A,” “RECOVERY\_2,” and “TEST\_18jun02” can be used.

### Zone configurations

A *zone configuration* is a group of one or more zones. A zone can be included in more than one zone configuration. When a zone configuration is in effect, all zones that are members of that configuration are in effect.

Several zone configurations can reside on a switch at once, and you can quickly alternate between them. For example, you might want to have one configuration enabled during the business hours and another enabled overnight. However, only one zone configuration can be enabled at a time.

The different types of zone configurations are:

- **Defined Configuration**  
The complete set of all zone objects defined in the fabric.
- **Effective Configuration**  
A single zone configuration that is currently in effect. The effective configuration is built when you enable a specified zone configuration.
- **Saved Configuration**  
A copy of the defined configuration plus the name of the effective configuration, which is saved in flash memory. (You can also provide a backup of the zoning configuration and restore the zoning configuration.) There might be differences between the saved configuration and the defined configuration if you have modified any of the zone definitions and have not saved the configuration.
- **Disabled Configuration**  
The effective configuration is removed from flash memory.

When you disable the effective configuration, the Advanced Zoning feature is disabled on the fabric, and all devices within the fabric can communicate with all other devices (unless you previously set up a default zone, as described in [“Default zoning mode”](#) on page 252). This does not mean that the zoning database is deleted, however, only that there is no configuration active in the fabric.

On power-up, the switch automatically reloads the saved configuration. If a configuration was active when it was saved, the same configuration is reinstated on the local switch.

### Zoning enforcement

Zoning enforcement describes a set of predefined rules that the switch uses to determine where to send incoming data. There are two methods of enforcement:

- Frame-based hardware enforcement
- Session-based hardware enforcement

Hardware-enforced zoning means that each frame is checked by hardware (the ASIC) before it is delivered to a zone member and is discarded if there is a zone mismatch. When hardware-enforced zoning is active, the Fabric OS switch monitors the communications and blocks any frames that do not comply with the effective zone configuration. The switch performs this blocking at the transmit side of the port on which the destination device is located.

Frame-based hardware enforcement is in effect, on a per-zone basis, if all members of a zone are identified the same way, either using WWNs or *domain,index* notation, with no overlapping zones.

Session-based hardware enforcement is in effect in the following cases, on a per-zone basis:

- A zone does not have either all WWN or all D,I entries.
- Overlapping zones (in which zone members appear in two or more zones).

### *Identifying the enforced zone type*

1. Connect to the switch and log in as admin.
2. Enter the **portZoneShow** command, using the following syntax:

```
portzonestow
```

## Considerations for zoning architecture

Table 50 lists considerations for zoning architecture.

**TABLE 50** Considerations for zoning architecture

Item	Description
Type of zoning enforcement: frame- or session-based	If security is a priority, frame-based hardware enforcement is recommended.
Use of aliases	The use of aliases is optional with zoning. Using aliases requires structure when defining zones. Aliases aid administrators of zoned fabrics in understanding the structure and context.
Interoperability mode	See <a href="#">Chapter 14, "Interoperability for Merged SANs,"</a> for interoperability mode considerations when using zoning.
Effect of changes in a production fabric	Zone changes in a production fabric can result in a disruption of I/O under conditions when an RSCN is issued because of the zone change and the HBA is unable to process the RSCN fast enough. Although RSCNs are a normal part of a functioning SAN, the pause in I/O might not be acceptable. For these reasons, you should perform zone changes only when the resulting behavior is predictable and acceptable. Ensuring that the HBA drivers are current can shorten the response time in relation to the RSCN.
Testing	Before implementing a new zone, you should run the Zone Analyzer from Web Tools to isolate any possible problems. This is especially useful as fabrics increase in size.
Confirming operation	After changing or enabling a zone configuration, you should confirm that the nodes and storage can identify and access one another. Depending on the platform, you might need to reboot one or more nodes in the fabric with the new changes.

Zoning can be implemented and administered from any switch in the fabric, although it is recommended that you use a switch running the latest Fabric OS version. If the switch is running Fabric OS v6.0.x or earlier, it must have an Advanced Zoning license enabled.

The zone configuration is managed on a fabric basis. When a change in the configuration is saved, enabled, or disabled according to the transactional model, it is automatically (by closing the transaction) distributed to all switches in the fabric, preventing a single point of failure for zone information.

#### **NOTE**

Zoning commands make changes that affect the entire fabric. When executing fabric-level configuration tasks, allow time for the changes to propagate across the fabric before executing any subsequent commands. For a large fabric, you should wait several minutes between commands.

## Best practices for zoning

The following are recommendations for using zoning:

- Always zone using the highest Fabric OS-level switch.  
Switches with earlier Fabric OS versions do not have the capability to view all the functionality that a newer Fabric OS provides, as functionality is backwards compatible but not forwards compatible.
- Zone using the core switch versus an edge switch.
- Zone using an enterprise-class platform rather than a switch.  
An enterprise-class platform has more resources to handle zoning changes and implementations.

## Broadcast zones

Fibre Channel allows sending broadcast frames to all Nx\_Ports if the frame is sent to a broadcast well-known address (FFFFFF); however, many target devices and HBAs cannot handle broadcast frames. To control which devices receive broadcast frames, you can create a special zone, called a *broadcast zone*, that restricts broadcast packets to only those devices that are members of the broadcast zone.

If there are no broadcast zones or if a broadcast zone is defined but not enabled, broadcast frames are not forwarded to any F\_Ports. If a broadcast zone is enabled, broadcast frames are delivered only to those logged-in Nx\_Ports that are members of the broadcast zone and are also in the same zone (regular zone) as the sender of the broadcast packet.

Devices that are not members of the broadcast zone can send broadcast packets, even though they cannot receive them.

A broadcast zone can have *domain,port*, WWN, and alias members.

Broadcast zones do not function in the same way as other zones. A broadcast zone does not allow access within its members in any way. If you want to allow or restrict access between any devices, you must create regular zones for that purpose. If two devices are not part of a regular zone, they cannot exchange broadcast or unicast packets.

To restrict broadcast frames reaching broadcast-incapable devices, create a broadcast zone and populate it with the devices that are capable of handling broadcast packets. Devices that cannot handle broadcast frames must be kept out of the broadcast zone so that they do not receive any broadcast frames.

You create a broadcast zone the same way you create any other zone except that a broadcast zone must have the name "broadcast" (case-sensitive). You set up and manage broadcast zones using the standard zoning commands, described in "[Zone creation and maintenance](#)" on page 249.

## Broadcast zones and Admin Domains

Each Admin Domain can have only one broadcast zone. However, all of the broadcast zones from all of the Admin Domains are considered as a single consolidated broadcast zone.

Broadcast packets are forwarded to all the ports that are part of the broadcast zone for any Admin Domain, have membership in that Admin Domain, and are zoned together (in a regular zone) with the sender of the broadcast frame.

Figure 33 illustrates how broadcast zones work with Admin Domains. Figure 33 shows a fabric with five devices and two Admin Domains, AD1 and AD2. Each Admin Domain has two devices and a broadcast zone.

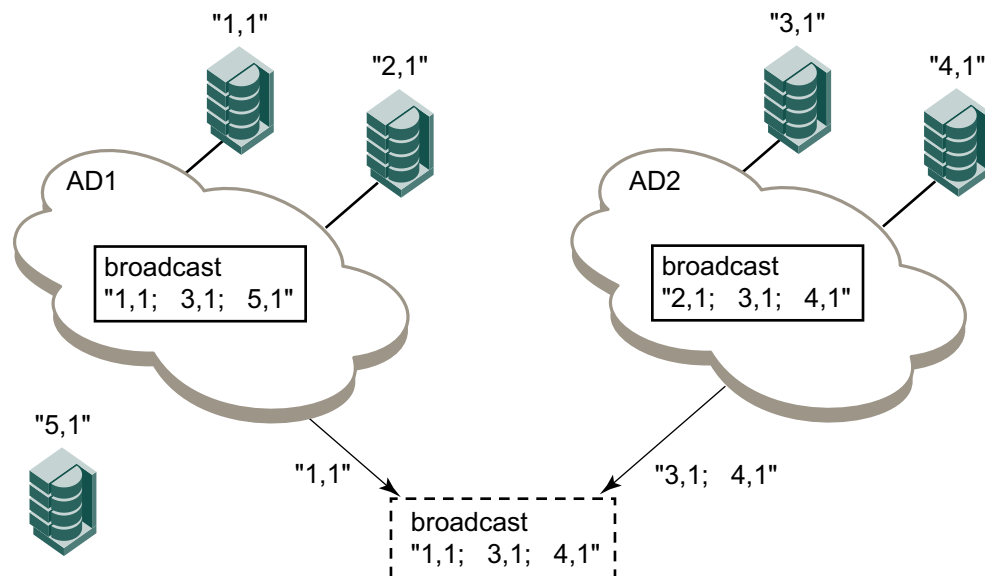

FIGURE 33 Broadcast zones and Admin Domains

The dotted box represents the consolidated broadcast zone, which contains all of the devices that can receive broadcast packets. The actual delivery of broadcast packets is also controlled by the Admin Domain and zone enforcement logic. The consolidated broadcast zone is not an actual zone, but is just an abstraction used for explaining the behavior.

- The broadcast zone for AD1 includes member devices "1,1", "3,1" and "5,1"; however, "3,1" and "5,1" are not members of AD1. Consequently, from the AD1 broadcast zone, only "1,1" is added to the consolidated broadcast zone.
- The broadcast zone for AD2 includes member devices "2,1", "3,1", and "4,1". Even though "2,1" is a member of AD1, it is not a member of AD2 and so is not added to the consolidated broadcast zone.
- Device "3,1" is added to the consolidated broadcast zone because of its membership in the AD2 broadcast zone.

When a switch receives a broadcast packet it forwards the packet only to those devices which are zoned with the sender and are also part of the consolidated broadcast zone.

You can check whether a broadcast zone has any invalid members that cannot be enforced in the current AD context. Refer to "Validating a zone" on page 251 for complete instructions.

## Broadcast zones and FC-FC routing

If you create broadcast zones in a metaSAN consisting of multiple fabrics connected through an FC router, the broadcast zone must include the IP device that exists in the edge or backbone fabric as well as the proxy device in the remote fabric. See Chapter 21, "Using the FC-FC Routing Service," for information about proxy devices and the FC router.

## High availability considerations with broadcast zones

If a switch has broadcast zone-capable firmware on the active CP (Fabric OS v5.3.x or later) and broadcast zone-incapable firmware on the standby CP (Fabric OS version earlier than v5.3.0), then you cannot create a broadcast zone because the zoning behavior would not be the same across an HA failover. If the switch failed over, then the broadcast zone would lose its special significance and would be treated as a regular zone.

## Loop devices and broadcast zones

Delivery of broadcast packets to individual devices in a loop is not controlled by the switch. Consequently, adding loop devices to a broadcast zone does not have any effect. If a loop device is part of a broadcast zone, then all devices in that loop receive broadcast packets.

**Best practice:** All devices in a single loop should have uniform broadcast capability. If all the devices in the loop can handle broadcast frames, then add the FL\_Port to the broadcast zone.

## Broadcast zones and default zoning

The default zoning mode defines the device accessibility behavior if zoning is not implemented or if there is no effective zone configuration. The default zoning mode has two options:

- All Access—All devices within the fabric can communicate with all other devices.
- No Access—Devices in the fabric cannot access any other device in the fabric.

If a broadcast zone is active, even if it is the only zone in the effective configuration, the default zone setting is not in effect.

If the effective configuration has only a broadcast zone, then the configuration appears as a No Access configuration. To change this configuration to All Access, you must put all the available devices in a regular zone.

See [“Default zoning mode”](#) on page 252 for additional information about default zoning.

## Zone aliases

A zone alias is a logical group of ports or WWNs. You can simplify the process of creating zones by first specifying aliases, which eliminates the need for long lists of individual zone member names.

If you are creating a new alias using **aliCreate w**, **“1,1”**, and a user in another Telnet session executes **cfgEnable** (or **cfgDisable**, or **cfgSave**), the other user’s transaction will abort your transaction and you will receive an error message. Creating a new alias while there is a zone merge taking place might also abort your transaction. For more details about zone merging and zone merge conflicts, see [“New switch or fabric additions”](#) on page 261.

**Virtual Fabric considerations:** Alias definitions should not include logical port numbers. Zoning is not enforced on logical ports.

## Creating an alias

1. Connect to the switch and log in as admin.
2. Enter the **aliCreate** command, using the following syntax:

```
alicreate "aliasname", "member[; member...]"
```

3. Enter the **cfgSave** command to save the change to the defined configuration.

The **cfgSave** command ends and commits the current zoning transaction buffer to nonvolatile memory. If a transaction is open on a different switch in the fabric when this command is run, the transaction on the other switch is automatically aborted. A message displays on the other switches to indicate that the transaction was aborted.

#### Example

```
switch:admin> alicreate "array1", "2,32; 2,33; 2,34; 4,4"
switch:admin> alicreate "array2", "21:00:00:20:37:0c:66:23; 4,3"
switch:admin> alicreate "loop1", "4,6"
switch:admin> cfgsave
You are about to save the Defined zoning configuration. This
action will only save the changes on the Defined configuration.
Any changes made on the Effective configuration will not
take effect until it is re-enabled.
Do you want to save Defined zoning configuration only? (yes, y, no, n): [no] y
```

## Adding members to an alias

1. Connect to the switch and log in as admin.
2. Enter the **aliAdd** command, using the following syntax:

```
aliadd "aliasname", "member[; member...]"
```

3. Enter the **cfgSave** command to save the change to the defined configuration.

The **cfgSave** command ends and commits the current zoning transaction buffer to nonvolatile memory. If a transaction is open on a different switch in the fabric when this command is run, the transaction on the other switch is automatically aborted. A message displays on the other switches to indicate that the transaction was aborted.

#### Example

```
switch:admin> aliadd "array1", "1,2"
switch:admin> aliadd "array2", "21:00:00:20:37:0c:72:51"
switch:admin> aliadd "loop1", "5,6"
switch:admin> cfgsave
You are about to save the Defined zoning configuration. This
action will only save the changes on the Defined configuration.
Any changes made on the Effective configuration will not
take effect until it is re-enabled.
Do you want to save Defined zoning configuration only? (yes, y, no, n): [no] y
```

## Removing members from an alias

1. Connect to the switch and log in as admin.
2. Enter the **aliRemove** command, using the following syntax:

```
aliremove "aliasname", "member[; member...]"
```

3. Enter the **cfgSave** command to save the change to the defined configuration.

The **cfgSave** command ends and commits the current zoning transaction buffer to nonvolatile memory. If a transaction is open on a different switch in the fabric when this command is run, the transaction on the other switch is automatically aborted. A message displays on the other switches to indicate that the transaction was aborted.

## Example

```
switch:admin> aliremove "array1", "1,2"
switch:admin> aliremove "array2", "21:00:00:20:37:0c:72:51"
switch:admin> aliremove "loop1", "4,6"
switch:admin> cfgsave
You are about to save the Defined zoning configuration. This
action will only save the changes on the Defined configuration.
Any changes made on the Effective configuration will not
take effect until it is re-enabled.
Do you want to save Defined zoning configuration only? (yes, y, no, n): [no] y
```

## Deleting an alias

1. Connect to the switch and log in as admin.
2. Enter the **aliDelete** command, using the following syntax.

```
alidelete "aliasname"
```

3. Enter the **cfgSave** command to save the change to the defined configuration.

The **cfgSave** command ends and commits the current zoning transaction buffer to nonvolatile memory. If a transaction is open on a different switch in the fabric when this command is run, the transaction on the other switch is automatically aborted. A message displays on the other switches to indicate that the transaction was aborted.

## Example

```
switch:admin> alidelete "array1"
switch:admin> cfgsave
You are about to save the Defined zoning configuration. This
action will only save the changes on the Defined configuration.
Any changes made on the Effective configuration will not
take effect until it is re-enabled.
Do you want to save Defined zoning configuration only? (yes, y, no, n): [no] y
```

## Viewing an alias in the defined configuration

1. Connect to the switch and log in as admin.
2. Enter the **aliShow** command, using the following syntax

```
alishow "pattern"[, mode]
```

If no parameters are specified, the entire zone database (both the defined and effective configuration) is displayed.

## Example

The following example shows all zone aliases beginning with “arr”.

```
switch:admin> alishow "arr*"
alias: array1  21:00:00:20:37:0c:76:8c
alias: array2  21:00:00:20:37:0c:66:23
```



## Zone creation and maintenance

To create a broadcast zone, use the reserved name “broadcast”. Do not give a regular zone the name of “broadcast”. See [“Broadcast zones”](#) on page 244 for additional information about this special type of zone.

**Virtual Fabric considerations:** Zone definitions should not include logical port numbers. Zoning is not enforced on logical ports.

### Creating a zone

1. Connect to the switch and log in as admin.
2. Enter the **zoneCreate** command, using the following syntax:

```
zonecreate "zonename", "member[; member...]"
```

To create a broadcast zone, use the reserved name “broadcast”.

3. Enter the **cfgSave** command to save the change to the defined configuration.

The **cfgSave** command ends and commits the current zoning transaction buffer to nonvolatile memory. If a transaction is open on a different switch in the fabric when this command is run, the transaction on the other switch is automatically aborted. A message displays on the other switches to indicate that the transaction was aborted.

#### Example

```
switch:admin> zonecreate "greenzone", "2,32; 2,33; 2,34; 4,4"
switch:admin> zonecreate "bluezone", "21:00:00:20:37:0c:66:23; 4,3"
switch:admin> zonecreate "broadcast", "1,2; 2,33; 2,34"
switch:admin> cfgsave
You are about to save the Defined zoning configuration. This
action will only save the changes on the Defined configuration.
Any changes made on the Effective configuration will not
take effect until it is re-enabled.
Do you want to save Defined zoning configuration only? (yes, y, no, n): [no] y
```

### Adding devices (members) to a zone

1. Connect to the switch and log in as admin.
2. Enter the **zoneAdd** command, using the following syntax:

```
zoneadd "zonename", "member[; member...]"
```

3. Enter the **cfgSave** command to save the change to the defined configuration.

The **cfgSave** command ends and commits the current zoning transaction buffer to nonvolatile memory. If a transaction is open on a different switch in the fabric when this command is run, the transaction on the other switch is automatically aborted. A message displays on the other switches to indicate that the transaction was aborted.

#### Example

```
switch:admin> zoneadd "greenzone", "1,2"
switch:admin> zoneadd "bluezone", "21:00:00:20:37:0c:72:51"
switch:admin> zoneadd "broadcast", "1,3"
switch:admin> cfgsave
You are about to save the Defined zoning configuration. This
```

## 11 Zone creation and maintenance

action will only save the changes on the Defined configuration.  
Any changes made on the Effective configuration will not  
take effect until it is re-enabled.  
Do you want to save Defined zoning configuration only? (yes, y, no, n): [no] **y**

### Removing devices (members) from a zone

1. Connect to the switch and log in as admin.
2. Enter the **zoneRemove** command, using the following syntax:

```
zoneremove "zonename", "member[; member...]"
```

3. Enter the **cfgSave** command to save the change to the defined configuration.

The **cfgSave** command ends and commits the current zoning transaction buffer to nonvolatile memory. If a transaction is open on a different switch in the fabric when this command is run, the transaction on the other switch is automatically aborted. A message displays on the other switches to indicate that the transaction was aborted.

#### Example

```
switch:admin> zoneremove "greenzone", "1,2"  
switch:admin> zoneremove "bluezone", "21:00:00:20:37:0c:72:51"  
switch:admin> zoneremove "broadcast", "2,34"  
switch:admin> cfgsave  
You are about to save the Defined zoning configuration. This  
action will only save the changes on the Defined configuration.  
Any changes made on the Effective configuration will not  
take effect until it is re-enabled.  
Do you want to save Defined zoning configuration only? (yes, y, no, n): [no] y
```

### Deleting a zone

1. Connect to the switch and log in as admin.
2. Enter the **zoneDelete** command, using the following syntax:

```
zonedeletem "zonename"
```

3. Enter the **cfgSave** command to save the change to the defined configuration.

The **cfgSave** command ends and commits the current zoning transaction buffer to nonvolatile memory. If a transaction is open on a different switch in the fabric when this command is run, the transaction on the other switch is automatically aborted. A message displays on the other switches to indicate that the transaction was aborted.

#### Example

```
switch:admin> zonedeletem "bluezone"  
switch:admin> cfgsave  
You are about to save the Defined zoning configuration. This  
action will only save the changes on the Defined configuration.  
Any changes made on the Effective configuration will not  
take effect until it is re-enabled.  
Do you want to save Defined zoning configuration only? (yes, y, no, n): [no] y
```

## Viewing a zone in the defined configuration

1. Connect to the switch and log in as admin.
2. Enter the **zoneShow** command, using the following syntax:

```
zoneshow[--sort] ["pattern"] [, mode]
```

If no parameters are specified, the entire zone database (both the defined and effective configuration) is displayed.

### Example

The following example shows all zones beginning with A, B, or C, in ascending order:

```
switch:admin> zoneshow --sort "[A-C]*"
zone: Blue_zone 1,1; array1; 1,2; array2
zone: Bobs_zone 4,5; 4,6; 4,7; 4,8; 4,9
```

## Validating a zone

1. Connect to the switch and log in as admin.
2. Enter the **cfgShow** command to view the zone configuration objects you want to validate.

```
switch:admin> cfgShow
Defined configuration:
cfg: USA_cfg Purple_zone; White_zone; Blue_zone
zone: Blue_zone
      1,1; array1; 1,2; array2
zone: Purple_zone
      1,0; loop1
zone: White_zone
      1,3; 1,4
alias: array1 21:00:00:20:37:0c:76:8c; 21:00:00:20:37:0c:71:02
alias: array2 21:00:00:20:37:0c:76:22; 21:00:00:20:37:0c:76:28
alias: loop1 21:00:00:20:37:0c:76:85; 21:00:00:20:37:0c:71:df
```

3. Enter the **zone --validate** command to list all zone members that are not part of the current zone enforcement table. Note that zone configuration names are case-sensitive; blank spaces are ignored.

```
switch:admin> zone --validate "White_zone"
```

4. Enter the following command to validate all zones in the zone database in the defined configuration.

```
switch:admin> sw5:root> zone --validate -m 1
Defined configuration:
cfg:  cfg1  zone1
cfg:  cfg2  zone1; zone2
zone: zone1  1,1; ali1
zone: zone2  1,1; ali2
alias: ali1  10:00:00:05:1e:35:81:7f*; 10:00:00:05:1e:35:81:7d*
alias: ali2  10:00:00:05:1e:35:81:09*; 10:00:00:05:1e:35:81:88*
```

```
-----
~ - Invalid configuration
* - Member does not exist
```

## 11 Default zoning mode

The mode flag **-m** can be used to specify the zone database location. Supported mode flag values are:

- 0 - zone database from the current transaction buffer
- 1 - zone database stored from the persistent storage
- 2 - currently effective zone database.

If no mode options are given, the validated output of all three buffers is shown.

If the **-f** option is specified, all the zone members that are not enforceable would be expunged in the transaction buffer. This pruning operation always happens on the transaction and defined buffers. You cannot specify a mode option or specify a zone object as an argument with the **-f** option. This mode flag should be used after the zone has been validated.

## Default zoning mode

The default zoning mode controls device access if zoning is not implemented or if there is no effective zone configuration. The default zoning mode has two options:

- All Access—All devices within the fabric can communicate with all other devices.
- No Access—Devices in the fabric cannot access any other device in the fabric.

The default zone mode applies to the entire fabric, regardless of switch model.

The default setting is All Access.

Typically, when you disable the zoning configuration in a large fabric with thousands of devices, the name server indicates to all hosts that they can communicate with each other. In fact, each host can receive an enormous list of PIDs, and ultimately cause other hosts to run out of memory or crash. To ensure that all devices in a fabric do not see each other during a configuration disable operation, set the default zoning mode to No Access.

---

### ATTENTION

For switches in large fabrics connected to thousands of devices, the default zone mode should be set to No Access. If the default zone mode is All Access and the effective configuration is disabled, the large number of requests to the switches might result in a queue full scenario.

---

**Admin Domain considerations:** If you want to use Admin Domains, you must set the default zoning mode to No Access prior to setting up the Admin Domains. You cannot change the default zoning mode to All Access if user-specified Admin Domains are present in the fabric.

## Setting the default zoning mode

1. Connect to the switch and log in as admin.
2. Enter the **cfgActvShow** command to view the current zone configuration.
3. Enter the **defZone** command with one of the following options:

```
defzone --noaccess
```

```
defzone --allaccess
```

This command initiates a transaction (if one is not already in progress).

4. Enter either the **cfgSave**, **cfgEnable**, or **cfgDisable** command to commit the change and distribute it to the fabric. The change will not be committed and distributed across the fabric if you do not enter one of these commands.

**Example**

```
switch:admin> defzone --noaccess
You are about to set the Default Zone access mode to No Access
Do you want to set the Default Zone access mode to No Access ? (yes, y, no, n):
[no] y

switch:admin> cfgsave
You are about to save the Defined zoning configuration. This
action will only save the changes on Defined configuration.
Any changes made on the Effective configuration will not
take effect until it is re-enabled.
Do you want to save Defined zoning configuration only? (yes, y, no, n): [no] y
Updating flash ...
```

## Viewing the current default zone access mode

1. Connect to the switch and log in as admin.
2. Enter the **defZone --show** command.

---

**NOTE**

If you perform a firmware download of an older release, then the current default zone access state will appear as it did prior to the download. For example, if the default zoning mode was No Access before the download, it will remain as No Access afterward.

---

## Zoning database size

The maximum size of a zone database is the upper limit for the defined configuration, and it is determined by the amount of flash memory available for storing the defined configuration.

Use the **cfgSize** command to display the zoning database size.

The supported maximum zoning database size is 1 MB.

## Zoning configurations

You can store a number of zones in a zoning configuration database. The maximum number of items that can be stored in the zoning configuration database depends on the following criteria:

- Number of switches in the fabric.
- Whether or not interoperability mode is enabled.
- Number of bytes for each item name. The number of bytes required for an item name depends on the specifics of the fabric, but cannot exceed 64 bytes for each item.

When enabling a new zone configuration, ensure that the size of the defined configuration does not exceed the maximum configuration size supported by all switches in the fabric. This is particularly important if you downgrade to a Fabric OS version that supports a smaller zone database than the current Fabric OS. In this scenario, the zone database in the current Fabric OS would have to be changed to the smaller zone database before the downgrade.

You can use the **cfgSize** command to check both the maximum available size and the currently saved size on all switches. If you think you are approaching the maximum, you can save a partially completed zoning configuration and use the **cfgSize** command to determine the remaining space. The **cfgSize** command reports the maximum available size on the current switch only. It cannot determine the maximum available size on other switches in the fabric.

---

### NOTE

The minimum zoning database size is 4 bytes, even if the zoning database is empty.

---

For important considerations for managing zoning in a fabric, and more details about the maximum zone database size for each version of the Fabric OS, see [“Zoning database size”](#) on page 253.

If you create or make changes to a zone configuration, you must enable the configuration for the changes to take effect.

## Creating a zoning configuration

1. Connect to the switch and log in as admin.
2. Enter the **cfgCreate** command, using the following syntax:

```
cfgcreate "cfgname", "member[; member...]"
```

3. Enter the **cfgSave** command to save the change to the defined configuration.

The **cfgSave** command ends and commits the current zoning transaction buffer to nonvolatile memory. If a transaction is open on a different switch in the fabric when this command is run, the transaction on the other switch is automatically aborted. A message displays on the other switches to indicate that the transaction was aborted.

### Example

```
switch:admin> cfgcreate "NEW_cfg", "purplezone; bluezone; greenzone"
switch:admin> cfgsave
You are about to save the Defined zoning configuration. This
action will only save the changes on the Defined configuration.
Any changes made on the Effective configuration will not
take effect until it is re-enabled.
Do you want to save Defined zoning configuration only? (yes, y, no, n): [no] y
```

## Adding zones (members) to a zoning configuration

1. Connect to the switch and log in as admin.
2. Enter the **cfgAdd** command, using the following syntax:

```
cfgadd "cfgname", "member[; member...]"
```

3. Enter the **cfgSave** command to save the change to the defined configuration.

The **cfgSave** command ends and commits the current zoning transaction buffer to nonvolatile memory. If a transaction is open on a different switch in the fabric when this command is run, the transaction on the other switch is automatically aborted. A message displays on the other switches to indicate that the transaction was aborted.

#### Example

```
switch:admin> cfgadd "newcfg", "bluezone"
switch:admin> cfgsave
You are about to save the Defined zoning configuration. This
action will only save the changes on the Defined configuration.
Any changes made on the Effective configuration will not
take effect until it is re-enabled.
Do you want to save Defined zoning configuration only? (yes, y, no, n): [no] y
```

## Removing zones (members) from a zone configuration

1. Connect to the switch and log in as admin.
2. Enter the **cfgRemove** command, using the following syntax:

```
cfgremove "cfgname", "member[; member...]"
```

3. Enter the **cfgSave** command to save the change to the defined configuration.

The **cfgSave** command ends and commits the current zoning transaction buffer to nonvolatile memory. If a transaction is open on a different switch in the fabric when this command is run, the transaction on the other switch is automatically aborted. A message displays on the other switches to indicate that the transaction was aborted.

#### Example

```
switch:admin> cfgremove "NEW_cfg", "purplezone"
switch:admin> cfgsave
You are about to save the Defined zoning configuration. This
action will only save the changes on the Defined configuration.
Any changes made on the Effective configuration will not
take effect until it is re-enabled.
Do you want to save Defined zoning configuration only? (yes, y, no, n): [no] y
```

## Enabling a zone configuration

The following procedure ends and commits the current zoning transaction buffer to nonvolatile memory. If a transaction is open on a different switch in the fabric when this procedure is run, the transaction on the other switch is automatically aborted. A message displays on the other switches to indicate that the transaction was aborted.

1. Connect to the switch and log in as admin.
2. Enter the **cfgenable** command, using the following syntax:

```
cfgenable "cfgname"
```

3. Enter **y** at the prompt.

#### Example

```
switch:admin> cfgenable "USA_cfg"
You are about to enable a new zoning configuration.
This action will replace the old zoning configuration with the
current configuration selected. If the update includes changes
```

## 11 Zoning configurations

```
to one or more traffic isolation zones, the update may result in
localized disruption to traffic on ports associated with
the traffic isolation zone changes.
Do you want to enable 'USA_cfg' configuration (yes, y, no, n): [no] y
zone config "USA_cfg" is in effect
Updating flash ...
```

### Disabling a zone configuration

When you disable the current zone configuration, the fabric returns to non-zoning mode. All devices can then access each other or not, depending on the default zone access mode setting.

---

#### NOTE

If the default zoning mode is set to All Access and more than 120 devices are connected to the fabric, you cannot disable the zone configuration because this would enable All Access mode and cause a large number of requests to the switch. In this situation, set the default zoning mode to No Access prior to disabling the zone configuration. See [“Default zoning mode”](#) on page 252 for information about setting this mode to No Access.

---

The following procedure ends and commits the current zoning transaction buffer to nonvolatile memory. If a transaction is open on a different switch in the fabric when this procedure is run, the transaction on the other switch is automatically aborted. A message displays on the other switches to indicate that the transaction was aborted.

1. Connect to the switch and log in as admin.
2. Enter the **cfgdisable** command, using the following syntax:

```
cfgdisable
```

3. Enter **y** at the prompt.

#### Example

```
switch:admin> cfgdisable
You are about to disable zoning configuration. This
action will disable any previous zoning configuration enabled.
Do you want to disable zoning configuration? (yes, y, no, n): [no] y
```

### Deleting a zone configuration

1. Connect to the switch and log in as admin.
2. Enter the **cfgDelete** command, using the following syntax:

```
cfgdelete "cfgname"
```

3. Enter the **cfgSave** command to save the change to the defined configuration.

The **cfgSave** command ends and commits the current zoning transaction buffer to nonvolatile memory. If a transaction is open on a different switch in the fabric when this command is run, the transaction on the other switch is automatically aborted. A message displays on the other switches to indicate that the transaction was aborted.

#### Example

```
switch:admin> cfgdelete "testcfg"
switch:admin> cfgsave
You are about to save the Defined zoning configuration. This
action will only save the changes on the Defined configuration.
```



Any changes made on the Effective configuration will not take effect until it is re-enabled.

Do you want to save Defined zoning configuration only? (yes, y, no, n): [no] **y**

## Clearing changes to a configuration

1. Enter the **cfgTransAbort** command.

When this command is executed, all changes since the last save operation (performed with the **cfgSave**, **cfgEnable**, or **cfgDisable** command) are cleared.

### Example

In the following example, assume that the removal of a member from **zone1** was done in error:

```
switch:admin> zoneremove "zone1","3,5"
switch:admin> cfgtransabort
```

## Viewing all zone configuration information

If you do not specify an operand when executing the **cfgShow** command to view zone configurations, then all zone configuration information (both defined and effective) displays. If there is an outstanding transaction, then the newly edited zone configuration that has not yet been saved is displayed. If there are no outstanding transactions, then the committed zone configuration displays.

1. Connect to the switch and log in as admin.
2. Enter the **cfgShow** command with no operands.

### Example

```
switch:admin> cfgshow
Defined configuration:
  cfg:   USA1   Blue_zone
  cfg:   USA_cfg Purple_zone; Blue_zone
  zone:  Blue_zone
        1,1; array1; 1,2; array2
  zone:  Purple_zone
        1,0; loop1
  alias: array1  21:00:00:20:37:0c:76:8c; 21:00:00:20:37:0c:71:02
  alias: array2  21:00:00:20:37:0c:76:22; 21:00:00:20:37:0c:76:28
  alias: loop1   21:00:00:20:37:0c:76:85; 21:00:00:20:37:0c:71:df

Effective configuration:
  cfg:   USA_cfg
  zone:  Blue_zone
        1,1
        21:00:00:20:37:0c:76:8c
        21:00:00:20:37:0c:71:02
        1,2
        21:00:00:20:37:0c:76:22
        21:00:00:20:37:0c:76:28
  zone:  Purple_zone
        1,0
        21:00:00:20:37:0c:76:85
        21:00:00:20:37:0c:71:df
```

## Viewing selected zone configuration information

1. Connect to the switch and log in as admin.
2. Enter the **cfgShow** command and specify a pattern.

```
cfgshow "pattern" [, mode]
```

### Example

The following example displays all zone configurations that start with "Test":

```
switch:admin> cfgshow "Test*"
cfg:   Test1 Blue_zone
cfg:   Test_cfg Purple_zone; Blue_zone
```

## Viewing the configuration in the effective zone database

1. Connect to the switch and log in as admin.
2. Enter the **cfgActvShow** command.

### Example

```
switch:admin> cfgactvshow
Effective configuration:
  cfg:   NEW_cfg
  zone:  Blue_zone
         1,1
         21:00:00:20:37:0c:76:8c
         21:00:00:20:37:0c:71:02
         1,2
         21:00:00:20:37:0c:76:22
         21:00:00:20:37:0c:76:28
  zone:  Purple_zone
         1,0
         21:00:00:20:37:0c:76:85
         21:00:00:20:37:0c:71:df
```

## Clearing all zone configurations

1. Connect to the switch and log in as admin.
2. Enter the **cfgClear** command to clear all zone information in the transaction buffer.

---

### ATTENTION

Be careful using the **cfgClear** command because it deletes the defined configuration.

---

```
switch:admin> cfgclear
The Clear All action will clear all Aliases, Zones, FA Zones
and configurations in the Defined configuration.
cfgSave may be run to close the transaction or cfgTransAbort
may be run to cancel the transaction.
Do you really want to clear all configurations? (yes, y, no, n): [no]
```

3. Enter one of the following commands, depending on whether an effective zoning configuration exists:
  - If no effective zoning configuration exists, enter the **cfgSave** command.
  - If an effective zoning configuration exists, enter the **cfgDisable** command to disable and clear the zone configuration in nonvolatile memory for all switches in the fabric.

## Zone object maintenance

The following procedures describe how to copy, delete, and rename zone objects. Depending on the operation, a zone object can be a zone member, a zone alias, a zone, or a zone configuration.

### Copying a zone object

When you copy a zone object, the resulting object has the same name as the original. The zone object can be a zone configuration, a zone alias, or a zone.

1. Connect to the switch and log in as admin.
2. Enter the **cfgShow** command to view the zone configuration objects you want to copy.

```
cfgshow "pattern" [, mode]
```

For example, to display all zone configuration objects that start with "Test":

```
switch:admin> cfgshow "Test*"
cfg:   Test1 Blue_zone
cfg:   Test_cfg Purple_zone; Blue_zone
```

3. Enter the **zone --copy** command, specifying the zone objects you want to copy, along with the new object name. Note that zone configuration names are case-sensitive; blank spaces are ignored and it works in any Admin Domain other than AD255.

```
switch:admin> zone --copy Test1 US_Test1
```

4. Enter the **cfgShow** command to verify the new zone object is present.

```
switch:admin> cfgshow "Test*"
cfg:   Test1 Blue_zone
cfg:   Test_cfg Purple_zone; Blue_zone
switch:admin> cfgShow "US_Test1"
cfg:   US_Test1
           Blue_zone
```

5. If you want the change preserved when the switch reboots, enter the **cfgSave** command to save it to nonvolatile (flash) memory.
6. Enter the **cfgEnable** command for the appropriate zone configuration to make the change effective.

### Deleting a zone object

The following procedure removes all references to a zone object and then deletes the zone object. The zone object can be a zone member, a zone alias, or a zone.

1. Connect to the switch and log in as admin.
2. Enter the **cfgShow** command to view the zone configuration objects you want to delete.

```
switch:admin> cfgShow
Defined configuration:
cfg: USA_cfg Purple_zone; White_zone; Blue_zone
zone: Blue_zone
      1,1; array1; 1,2; array2
zone: Purple_zone
      1,0; loop1
zone: White_zone
      1,3; 1,4
```

## 11 Zone object maintenance

```
alias: array1 21:00:00:20:37:0c:76:8c; 21:00:00:20:37:0c:71:02
alias: array2 21:00:00:20:37:0c:76:22; 21:00:00:20:37:0c:76:28
alias: loop1 21:00:00:20:37:0c:76:85; 21:00:00:20:37:0c:71:df
```

Effective configuration:

```
cfg: USA_cfg
zone: Blue_zone
1,1
21:00:00:20:37:0c:76:8c
21:00:00:20:37:0c:71:02
1,2
21:00:00:20:37:0c:76:22
21:00:00:20:37:0c:76:28
zone: Purple_zone
1,0
21:00:00:20:37:0c:76:85
21:00:00:20:37:0c:71:df
```

3. Enter the **zone --expunge** command to delete the zone object. Zone configuration names are case-sensitive; blank spaces are ignored and it works in any Admin Domain other than AD255.

```
switch:admin> zone --expunge "White_zone"
You are about to expunge one configuration
or member. This action could result in removing
many zoning configurations recursively.
[Removing the last member of a configuration removes the configuration.]
Do you want to expunge the member? (yes, y, no, n): [no] yes
```

4. Enter **yes** at the prompt.
5. Enter the **cfgShow** command to verify the deleted zone object is no longer present.
6. If you want the change preserved when the switch reboots, enter the **cfgSave** command to save it to nonvolatile (flash) memory.
7. Enter the **cfgEnable** command for the appropriate zone configuration to make the change effective.

### Renaming a zone object

1. Connect to the switch and log in as admin.
2. Enter the **cfgShow** command to view the zone configuration objects you want to rename.

```
switch:admin> cfgShow
Defined configuration:
cfg: USA_cfg Purple_zone; White_zone; Blue_zone
zone: Blue_zone
      1,1; array1; 1,2; array2
zone: Purple_zone
      1,0; loop1
zone: White_zone
      1,3; 1,4
alias: array1 21:00:00:20:37:0c:76:8c; 21:00:00:20:37:0c:71:02
alias: array2 21:00:00:20:37:0c:76:22; 21:00:00:20:37:0c:76:28
alias: loop1 21:00:00:20:37:0c:76:85; 21:00:00:20:37:0c:71:df
```

3. Enter the **zoneObjectRename** command to rename zone configuration objects. Note that zone configuration names are case-sensitive; blank spaces are ignored and it works in any Admin Domain other than AD255.

```
switch:admin> zoneObjectRename "White_zone", "Purple_zone"
```

4. Enter the **cfgShow** command to verify the renamed zone object is present.
5. If you want the change preserved when the switch reboots, enter the **cfgSave** command to save it to nonvolatile (flash) memory.
6. Enter the **cfgEnable** command for the appropriate zone configuration to make the change effective.

## Zoning configuration management

You can add, delete, or remove individual elements in an existing zone configuration to create an appropriate configuration for your SAN environment. After the changes have been made, save the configuration to ensure the configuration is permanently saved in the switch and that the configuration is replicated throughout the fabric.

The switch configuration file can also be uploaded to the host for archiving and it can be downloaded from the host to a switch in the fabric. See [“Configuration file backup”](#) on page 178, [“Configuration file restoration”](#) on page 180, or the **configUpload** and **configDownload** commands in the *Fabric OS Command Reference* for additional information on uploading and downloading the configuration file.

### New switch or fabric additions

When a new switch is added to the fabric, it automatically takes on the zone configuration information from the fabric. You can verify the zoning configuration on the switch using the procedure described in [“Viewing the configuration in the effective zone database”](#) on page 258.

If you are adding a switch that is already configured for zoning, clear the zone configuration on that switch before connecting it to the zoned fabric. See [“Clearing all zone configurations”](#) on page 258 for instructions.

Adding a new fabric that has no zone configuration information to an existing fabric is very similar to adding a new switch. All switches in the new fabric inherit the zoning configuration data. If a zone configuration is in effect, then the same configuration becomes the enabled configuration.

Before the new fabric can merge successfully, it must pass the following criteria:

- Before merging zones

To facilitate merging, check the following before merging switches or fabrics:

- **Zoning licenses:** All switches running Fabric OS v6.0.x or earlier must have a Zoning license enabled.
- **Native operating mode:** All switches must be in the native operating mode.
- **Default Zone:** The switch being merged into the existing fabric should be configured with the same default zone mode as the existing switches.

- Merging and segmentation

The fabric is checked for segmentation during power-up or when a switch is disabled or enabled, or when a new switch is added.

## 11 Zoning configuration management

The database is the zone configuration database. (This is the data displayed as the “defined configuration” in the **cfgShow** command.) It is stored in nonvolatile memory by the **cfgSave** command. This database is a replicated database, which means that all switches in the fabric will have a copy of this database. When a change is made to the defined configuration, the switch where the changes were made must close its transaction for the change to be propagated throughout the fabric.

If you have implemented default zoning you must set the switch you are adding into the fabric to the same default zone mode setting as the rest of the fabric to avoid segmentation.

- Merging rules

Observe these rules when merging zones:

- Local and adjacent configurations: If the local and adjacent zone database configurations are the same, they will remain unchanged after the merge.
- Effective configurations: If there is an effective configuration between two switches, the effective zone configurations must match.
- Zone object naming: If a zoning object has the same name in both the local and adjacent defined configurations, the object types and member lists must match. When comparing member lists, the content and order of the members are important.
- Objects in adjacent configurations: If a zoning object appears in an adjacent defined configuration, but not in the local defined configuration, the zoning object is added to the local defined configuration. The modified zone database must fit in the nonvolatile memory area allotted for the zone database.
- Local configuration modification: If a local defined configuration is modified because of a merge, the new zone database is propagated to other the switches within the merge request.

- Merging two fabrics

Both fabrics have identical zones and configurations enabled, including the default zone mode. The two fabrics will join to make one larger fabric with the same zone configuration across the newly created fabric.

If the two fabrics have different zoning configurations, they will not be merged. If the two fabrics cannot join, the ISL between the switches will segment.

- Merge conflicts

When a merge conflict is present, a merge will not take place and the ISL will segment. Use the **switchShow** or **errDump** commands to obtain additional information about possible merge conflicts, because many non-zone related configuration parameters can cause conflicts. See the *Fabric OS Command Reference* for detailed information about these commands.

If the fabrics have different zone configuration data, the system attempts to merge the two sets of zone configuration data. If the zones cannot merge, the ISL will be segmented.

A merge is not possible if any of the following conditions exist:

- Configuration mismatch: Zoning is enabled in both fabrics and the zone configurations that are enabled are different in each fabric.
- Type mismatch: The name of a zone object in one fabric is used for a different type of zone object in the other fabric.
- Content mismatch: The definition of a zone object in one fabric is different from the definition of zone object with the same name in the other fabric.
- Zone Database Size: If the zone database size exceeds the maximum limit of another switch.

---

**NOTE**

If the zoneset members on two switches are not listed in the same order, the configuration is considered a mismatch, resulting in the switches being segmented from the fabric. For example: `cfg1 = z1; z2` is different from `cfg1 = z2; z1`, even though members of the configuration are the same. If zoneset members on two switches have the same names defined in the configuration, make sure zoneset members are listed in the same order.

---

## Fabric segmentation and zoning

If the connections between two fabrics are no longer available, the fabric segments into two separate fabrics. Each new fabric retains the same zone configuration.

If the connections between two fabrics are replaced and no changes have been made to the zone configuration in either of the two fabrics, then the two fabrics merge back into one single fabric. If any changes that cause a conflict have been made to either zone configuration, then the fabrics might segment.

## Security and zoning

Zones provide controlled access to fabric segments and establish barriers between operating environments. They isolate systems with different uses, protecting individual systems in a heterogeneous environment; for example, when zoning is in secure mode, no merge operations occur.

Brocade Advanced Zoning is configured on the primary Fabric Configuration Server (FCS). The primary FCS switch makes zoning changes and other security-related changes. The primary FCS switch also distributes zoning to all other switches in the secure fabric. All existing interfaces can be used to administer zoning (depending on the policies; see the *Secure Fabric OS Administrator's Guide* for information about security policies).

You must perform zone management operations from the primary FCS switch using a zone management interface, such as Telnet or Advanced Web Tools. You can alter a zoning database, provided you are connected to the primary FCS switch.

# 11 Zone merging scenarios

When two secure fabrics join, the traditional zoning merge does not occur. Instead, a zoning database is downloaded from the primary FCS switch of the merged secure fabric. When E\_Ports are active between two switches, the name of the FCS server and a zoning policy set version identifier are exchanged between the switches. If the views of the two secure fabrics are the same, the fabric's primary FCS server downloads the zoning database and security policy sets to each switch in the fabric. If there is a view conflict, the E\_Ports are segmented due to incompatible security data.

As part of zoning architecture, you must determine which of the two basic zoning architectures (hard or soft) works best for your fabric. With time and planning, the basic hard zone configuration works for most sites.

## Zone merging scenarios

Table 51 provides information on merging zones and the expected results.

**TABLE 51** Zone merging scenarios

Description	Switch A	Switch B	Expected results
<b>Switch A</b> has a defined configuration. <b>Switch B</b> does not have a defined configuration.	defined: cfg1: zone1: ali1; ali2 effective: none	defined: none effective: none	Configuration from <b>Switch A</b> to propagate throughout the fabric in an inactive state, because the configuration is not enabled.
<b>Switch A</b> has a defined and enabled configuration. <b>Switch B</b> has a defined configuration but no effective configuration.	defined: cfg1 zone1: ali1; ali2 effective: cfg1:	defined: cfg1 zone1: ali1; ali2 effective: none	Configuration from <b>Switch A</b> to propagate throughout the fabric. The configuration is enabled after the merge in the fabric.
<b>Switch A</b> and <b>Switch B</b> have the same defined configuration. Neither have an enabled configuration.	defined: cfg1 zone1: ali1; ali2 effective: none	defined: cfg1 zone1: ali1; ali2 effective: none	No change (clean merge).
<b>Switch A</b> and <b>Switch B</b> have the same defined and enabled configuration.	defined: cfg1 zone1: ali1; ali2 effective: cfg1:	defined: cfg1 zone1: ali1; ali2 effective: cfg1:	No change (clean merge).
<b>Switch A</b> does not have a defined configuration. <b>Switch B</b> has a defined configuration.	defined: none effective: none	defined:cfg1 zone1: ali1; ali2 effective: none	<b>Switch A</b> will absorb the configuration from the fabric.
<b>Switch A</b> does not have a defined configuration. <b>Switch B</b> has a defined configuration.	defined: none effective: none	defined:cfg1 zone1: ali1; ali2 effective: cfg1	<b>Switch A</b> will absorb the configuration from the fabric, with cfg1 as the effective configuration.
<b>Switch A</b> and <b>Switch B</b> have the same defined configuration. Only <b>Switch B</b> has an enabled configuration.	defined: cfg1 zone1: ali1; ali2 effective: none	defined: cfg1 zone1: ali1; ali2 effective: cfg1	Clean merge, with cfg1 as the effective configuration.
<b>Switch A</b> and <b>Switch B</b> have different defined configurations. Neither have an enabled zone configuration.	defined: cfg2 zone2: ali3; ali4 effective: none	defined: cfg1 zone1: ali1; ali2 effective: none	Clean merge. The new configuration will be a composite of the two. defined: cfg1 zone1: ali1; ali2 cfg2: zone2: ali3; ali4 effective: none



TABLE 51 Zone merging scenarios (Continued)

Description	Switch A	Switch B	Expected results
<b>Switch A</b> and <b>Switch B</b> have different defined configurations. <b>Switch B</b> has an enabled configuration.	defined: cfg2 zone2: ali3; ali4 effective: none	defined: cfg1 zone1: ali1; ali2 effective: cfg1	Clean merge. The new configuration will be a composite of the two, with cfg1 as the effective configuration.
Effective configuration mismatch.	defined: cfg1 zone1: ali1; ali2 effective: cfg1 zone1: ali1; ali2	defined: cfg2 zone2: ali3; ali4 effective: cfg2 zone2: ali3; ali4	Fabric segments due to: Zone Conflict cfg mismatch
Configuration content mismatch.	defined: cfg1 zone1: ali1; ali2 effective: irrelevant	defined: cfg1 zone1: ali3; ali4 effective: irrelevant	Fabric segments due to: Zone Conflict content mismatch
Same content, different effective cfg name.	defined: cfg1 zone1: ali1; ali2 effective: cfg1 zone1: ali1; ali2	defined: cfg2 zone1: ali1; ali2 effective: cfg2 zone1: ali1; ali2	Fabric segments due to: Zone Conflict cfg mismatch
Same content, different zone name.	defined: cfg1 zone1: ali1; ali2 effective: irrelevant	defined: cfg1 zone2: ali1; ali2 effective: irrelevant	Fabric segments due to: Zone Conflict content mismatch
Same content, different alias name.	defined: cfg1 ali1: A; B effective: irrelevant	defined: cfg1 ali2: A; B effective: irrelevant	Fabric segments due to: Zone Conflict content mismatch
Same alias name, same content, different order.	defined: cfg1 ali1: A; B; C effective: irrelevant	defined: cfg1 ali1: B; C; A effective: irrelevant	Fabric segments due to: Zone Conflict content mismatch
Same name, different types.	effective: zone1: MARKETING	effective: cfg1: MARKETING	Fabric segments due to: Zone Conflict type mismatch
Same name, different types.	effective: zone1: MARKETING	effective: alias1: MARKETING	Fabric segments due to: Zone Conflict type mismatch
Same name, different types.	effective: cfg1: MARKETING	effective: alias1: MARKETING	Fabric segments due to: Zone Conflict type mismatch
<b>Switch A</b> does not have Traffic Isolation (TI) zones. <b>Switch B</b> has TI zones.	defined: cfg1	defined: cfg1 TI_zone1	Clean merge.
<b>Switch A</b> has TI zones. <b>Switch B</b> has identical TI zones.	defined: cfg1 TI_zone1	defined: cfg1 TI_zone1	Clean merge.
<b>Switch A</b> has a TI zone. <b>Switch B</b> has a different TI zone.	defined: cfg1 TI_zone1	defined: cfg1 TI_zone2	Fabric segments due to: Zone Conflict cfg mismatch. Cannot merge switches with different TI zone configurations.
Switch A has Enhanced TI zones. Switch B is running Fabric OS v6.4.0 or later.	defined: cfg1 TI_zone1 TI_zone2	defined: none	Clean merge.
Switch A has Enhanced TI zones. Switch B is running a Fabric OS version earlier than v6.4.0.	defined: cfg1 TI_zone1 TI_zone2	defined: none	Fabric segments because all switches in the fabric must be running Fabric OS v6.4.0 or later to support Enhanced TI zones.

# 11 Zone merging scenarios

**TABLE 51 Zone merging scenarios (Continued)**

Description	Switch A	Switch B	Expected results
Different default zone access mode settings.	defzone: allaccess	defzone: noaccess	Clean merge — noaccess takes precedence and defzone configuration from <b>Switch B</b> propagates to fabric. defzone: noaccess
Different default zone access mode settings.	defzone: noaccess	defzone: allaccess	Clean merge — noaccess takes precedence and defzone configuration from <b>Switch A</b> propagates to fabric. defzone: noaccess
Same default zone access mode settings.	defzone: allaccess	defzone: allaccess	Clean merge — defzone configuration is allaccess in the fabric.
Same default zone access mode settings.	defzone: noaccess	defzone: noaccess	Clean merge — defzone configuration is noaccess in the fabric.
Effective zone configuration.	No effective configuration. defzone = allaccess	effective: cfg2	Clean merge — effective zone configuration from <b>Switch B</b> propagates to fabric.
Effective zone configuration.	No effective configuration. defzone = noaccess	effective: cfg2	Fabric segments because <b>Switch A</b> has a hidden zone configuration (no access) activated and <b>Switch B</b> has an explicit zone configuration activated.

# Traffic Isolation Zoning

---

## In this chapter

- Traffic Isolation Zoning overview ..... 267
- Enhanced TI zones ..... 272
- Traffic Isolation Zoning over FC routers ..... 273
- General rules for TI zones ..... 276
- Supported configurations for Traffic Isolation Zoning. .... 277
- Limitations and restrictions of Traffic Isolation Zoning. .... 278
- Admin Domain considerations for Traffic Isolation Zoning. .... 279
- Virtual Fabric considerations for Traffic Isolation Zoning. .... 279
- Traffic Isolation Zoning over FC routers with Virtual Fabrics ..... 281
- Creating a TI zone ..... 282
- Modifying TI zones ..... 284
- Changing the state of a TI zone ..... 285
- Deleting a TI zone ..... 286
- Displaying TI zones ..... 286
- Setting up TI over FCR (sample procedure) ..... 287

## Traffic Isolation Zoning overview

The Traffic Isolation Zoning feature allows you to control the flow of interswitch traffic by creating a dedicated path for traffic flowing from a specific set of source ports (N\_Ports). For example, you might use Traffic Isolation Zoning for the following scenarios:

- To dedicate an ISL to high priority, host-to-target traffic.
- To force high volume, low priority traffic onto a given ISL to limit the effect on the fabric of this high traffic pattern.
- To ensure that requests and responses of FCIP-based applications such as tape pipelining use the same VE\_Port tunnel across a metaSAN.

Traffic Isolation Zoning does not require a license.

Traffic isolation is implemented using a special zone, called a *Traffic Isolation zone* (TI zone). A TI zone indicates the set of N\_Ports and E\_Ports to be used for a specific traffic flow. When a TI zone is activated, the fabric attempts to isolate all inter-switch traffic entering from a member of the zone to only those E\_Ports that have been included in the zone. The fabric also attempts to exclude traffic not in the TI zone from using E\_Ports within that TI zone.

Figure 34 shows a fabric with a TI zone consisting of the following:

- N\_Ports: “1,7”, “1,8”, “4,5”, and “4,6”
- E\_Ports: “1,1”, “3,9”, “3,12”, and “4,7”

The dotted line indicates the dedicated path between the initiator in Domain 1 to the target in Domain 4.

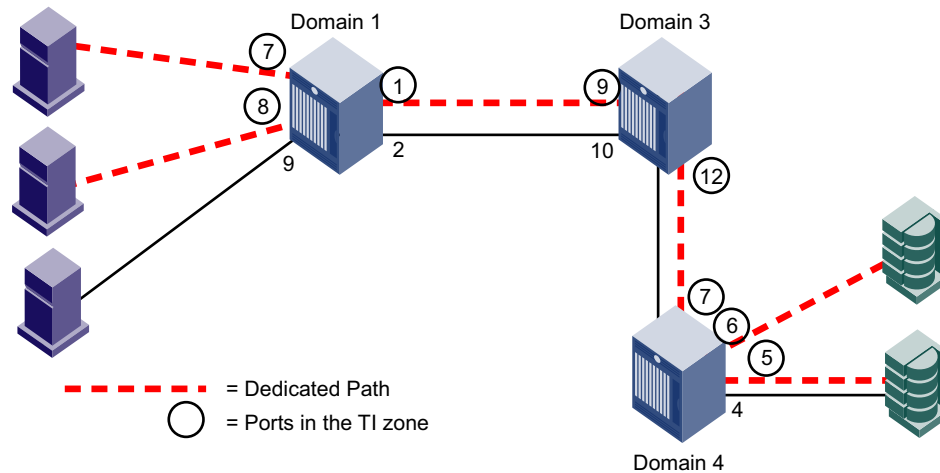

**FIGURE 34** Traffic Isolation zone creating a dedicated path through the fabric

In Figure 34, all traffic entering Domain 1 from N\_Ports 7 and 8 is routed through E\_Port 1. Similarly, traffic entering Domain 3 from E\_Port 9 is routed to E\_Port 12, and traffic entering Domain 4 from E\_Port 7 is routed to the devices through N\_Ports 5 and 6. Traffic coming from other ports in Domain 1 would *not* use E\_Port 1, but would use E\_Port 2 instead.

Use the **zone** command to create and manage TI zones. Refer to the *Fabric OS Command Reference* for details about the **zone** command.

## TI zone failover

A TI zone can have failover enabled or disabled.

Disable failover if you want to guarantee that TI zone traffic uses only the dedicated path, and that no other traffic can use the dedicated path.

Enable failover if you want traffic to have alternate routes if either the dedicated or non-dedicated paths cannot be used.

---

### ATTENTION

If failover is disabled, use care when planning your TI zones so that non-TI zone devices are not isolated. If this feature is not used correctly, it can cause major fabric disruptions that are difficult to resolve. See [“Additional considerations when disabling failover”](#) on page 269 for additional information about using this feature.

---

Table 52 compares the behavior of traffic when failover is enabled and disabled.

**TABLE 52** Comparison of traffic behavior when failover is enabled or disabled in TI zones

Failover enabled	Failover disabled
If the dedicated path is not the shortest path or if the dedicated path is broken, the TI zone traffic will use a non-dedicated path instead.	If the dedicated path is not the shortest path or if the dedicated path is broken, traffic for that TI zone is halted until the dedicated path is fixed.
Non-TI zone traffic will use the dedicated path if no other paths through the fabric exist, or if the non-dedicated paths are not the shortest paths.	Non-TI zone traffic will never use the dedicated path, even if the dedicated path is the shortest path or if there are no other paths through the fabric.

For example, in [Figure 34](#) on page 268, if the dedicated ISL between Domain 1 and Domain 3 goes offline, then the following occurs, depending on the failover option:

- If failover is enabled for the TI zone, the traffic is routed from Domain 1 to Domain 3 through E\_Ports “1,2” and “3,10”.
- If failover is disabled for the TI zone, the traffic is halted until the ISL between Domain 1 and Domain 3 is back online.

If the non-dedicated ISL between Domain 1 and Domain 3 goes offline, then the following occurs, depending on the failover option:

- If failover is enabled for the TI zone, non-TI zone traffic is routed from Domain 1 to Domain 3 through the dedicated ISL.

**NOTE**

When non-TI zone traffic enters the TI path, the non-TI zone traffic continues to flow through that path. In this example, when the non-TI zone traffic is routed through E\_Ports “1,1” and “3,9”, that traffic continues through E\_Ports “3,12” and “4,7”, even though the non-dedicated ISL between domains 3 and 4 is not broken.

- If failover is disabled for the TI zone, non-TI zone traffic is halted until the non-dedicated ISL between Domain 1 and Domain 3 is back online.

***Additional considerations when disabling failover***

If failover is disabled, be aware of the following considerations:

- This feature is intended for use in simple linear fabric configurations, such as that shown in [Figure 34](#) on page 268.
- Ensure that there are non-dedicated paths through the fabric for all devices that are not in a TI zone.
- If you create a TI zone with just E\_Ports, failover must be enabled. If failover is disabled, the specified ISLs will not be able to route any traffic.
- If the path between devices in a TI zone is broken, no inter-switch RSCNs are generated. Each switch that is part of the TI zone generates RSCNs to locally attached devices that are part of the TI zone and are registered to receive RSCNs.
- Ensure that there are multiple paths between switches.  
Disabling failover locks the specified route so that only TI zone traffic can use it. Non-TI zone traffic is excluded from using the dedicated path.
- It is recommended that TI zone definitions and regular zone definitions match.

- For the Brocade 300, 5000, 5100, 5300, 5410, 5424, 5450, 5460, 5470, 5480, 7800, 8000, VA-40FC, DCX, DCX-4S, and Brocade Encryption Switch: Domain controller frames can use any path between switches. Disabling failover does not affect Domain Controller connectivity.

For example, in [Figure 35](#), if failover is disabled, Domain 2 can continue to send domain controller frames to Domain 3 and 4, even though the path between Domain 1 and Domain 3 is a dedicated path. Domain controller frames include zone updates and Name Server queries.

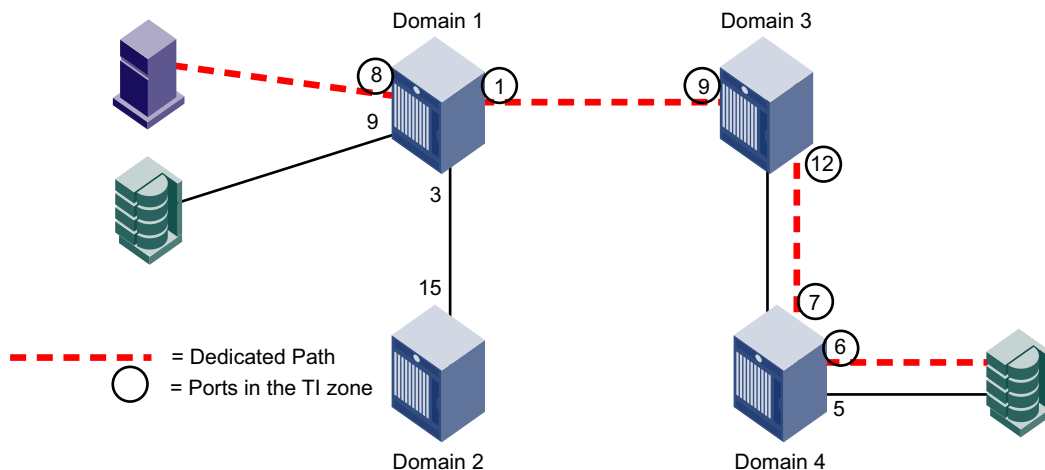

**FIGURE 35** Fabric incorrectly configured for TI zone with failover disabled

- For the Brocade 4100, 4900, 7500, 7500E, 7600, and 48000: Non-TI zone traffic, including domain controller frames, are excluded from using the dedicated path.

For example, in [Figure 35](#), if failover is disabled, Domain 2 cannot send domain controller frames to Domain 3 and 4. Domain controller frames include zone updates and Name Server queries. To avoid this problem, add a second, non-dedicated ISL between Domain 1 and 3.

- Disabling failover does not affect local connectivity.
 

For example, in [Figure 35](#), the initiator and target on Domain 1 are not in the same TI zone. If failover is disabled, the initiator and target on Domain 1 maintain connectivity, as long as they are in the same regular zone.
- It is recommended that the insistent Domain ID feature be enabled; if a switch changes its active domain ID, the route is broken. See the **configure** command in the *Fabric OS Command Reference* for information about setting insistent Domain ID.

## FSPF routing rules and traffic isolation

All traffic must use the lowest cost path. FSPF routing rules take precedence over the TI zones, as described in the following situations.

If the dedicated ISL is not the lowest cost path ISL, then the following rules apply:

- If failover is enabled, the traffic path for the TI zone is broken, and TI zone traffic uses the lowest cost path instead.
- If failover is disabled, the TI zone traffic is blocked.

If the dedicated ISL is the only lowest cost path ISL, then the following rules apply:

- If failover is enabled, non-TI zone traffic as well as TI zone traffic uses the dedicated ISL.

- If failover is disabled, non-TI zone traffic is blocked because it cannot use the dedicated ISL, which is the lowest cost path.

For example, in [Figure 36](#), there is a dedicated path between Domain 1 and Domain 3, and another, non-dedicated, path that passes through Domain 2. If failover is enabled, *all* traffic will use the dedicated path, because the non-dedicated path is not the shortest path. If failover is disabled, non-TI zone traffic is blocked because the non-dedicated path is not the shortest path.

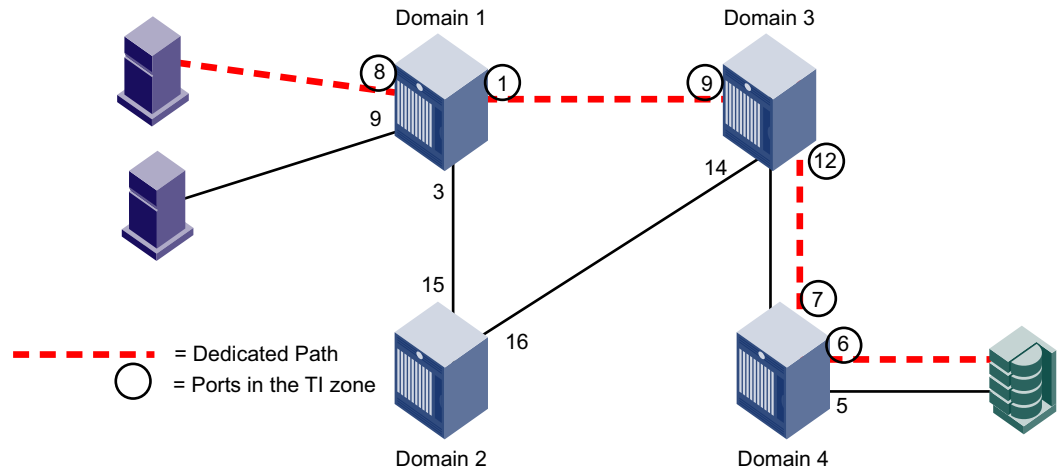

**FIGURE 36** Dedicated path is the only shortest path

In [Figure 37](#) on page 271, a dedicated path between Domain 1 and Domain 4 exists, but is not the shortest path. In this situation, if failover is enabled, the TI zone traffic uses the shortest path, even though the E\_Ports are not in the TI zone. If failover is disabled, the TI zone traffic stops until the dedicated path is configured to be the shortest path.

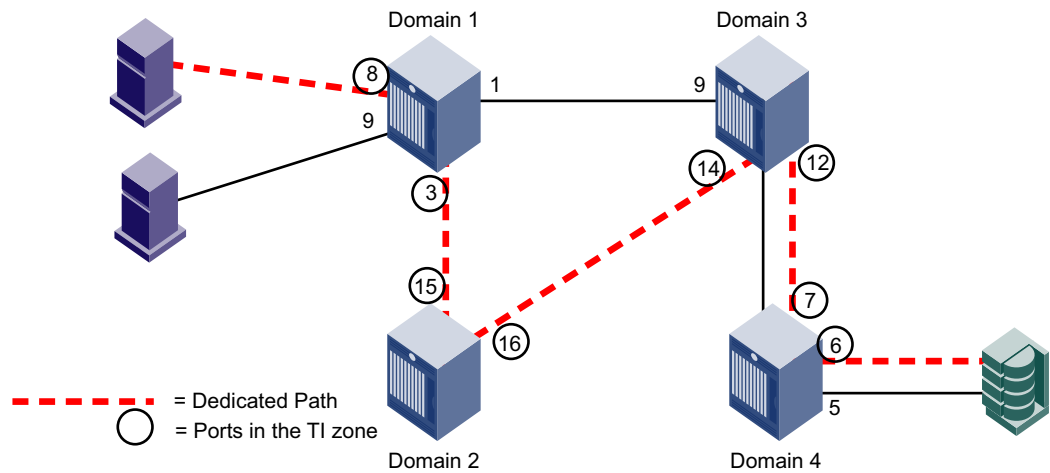

**FIGURE 37** Dedicated path is not the shortest path

**NOTE**

For information about setting or displaying the FSPF cost of a path, see the `linkCost` and `topologyShow` commands in the *Fabric OS Command Reference*.

## Enhanced TI zones

Prior to Fabric OS v6.4.0, a port could be in only one TI zone at a time. Starting in Fabric OS v6.4.0, ports can be in multiple TI zones at the same time. Zones with overlapping port members are called *enhanced TI zones* (ETIZ).

Figure 38 shows an example of two TI zones. Because these TI zones have an overlapping port (3,8), they are enhanced TI zones.

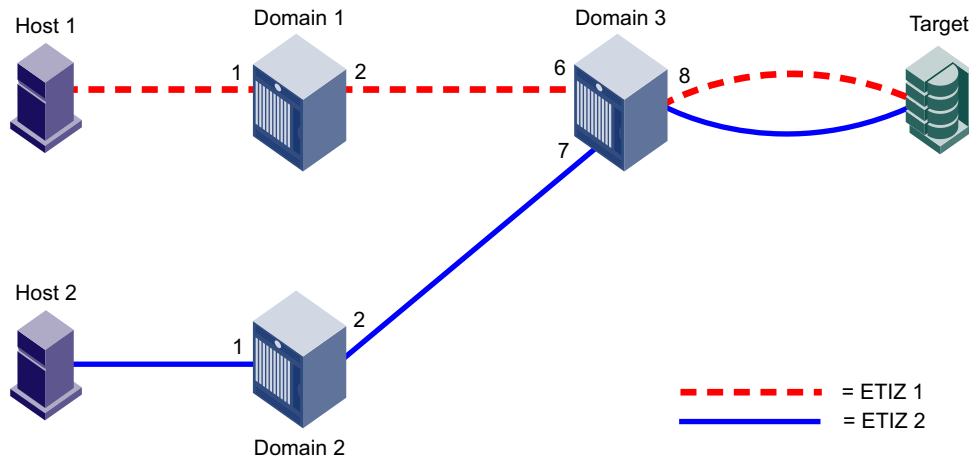

FIGURE 38 Enhanced TI zones

Enhanced TI zones are especially useful in FICON fabrics. See the *FICON Administrator's Guide* for example topologies using enhanced TI zones.

When you create TI zones, ensure that all traffic from a port to all destinations on a remote domain have the same path. You cannot create separate paths from a local port to two or more devices on the same remote domain.

Figure 39 on page 273 shows two enhanced TI zones that are configured incorrectly. If the TI zones are configured with failover disabled, some traffic will be dropped. If the TI zones are configured with failover enabled, all traffic will go through, but half of the traffic will be routed incorrectly according to the TI zone definitions.

This example contains two enhanced TI zones:

- ETIZ 1 contains (1,1), (1,2), (3,6), (3,8)
- ETIZ 2 contains (2,1), (2,2), (1,4), (1,3), (3,7), (3,8)

In this example traffic from the Target to Domain 2 is routed correctly. Only one TI zone describes a path to Domain 2. However, both TI zones describe different, valid paths from the Target to Domain 1. Only one path will be able to get to (1,1). Traffic from port (3,8) cannot be routed to Domain 1 over both (3,6) and (3,7), so one port will be chosen. If (3,7) is chosen, frames destined for (1,1) will be dropped at Domain 1.



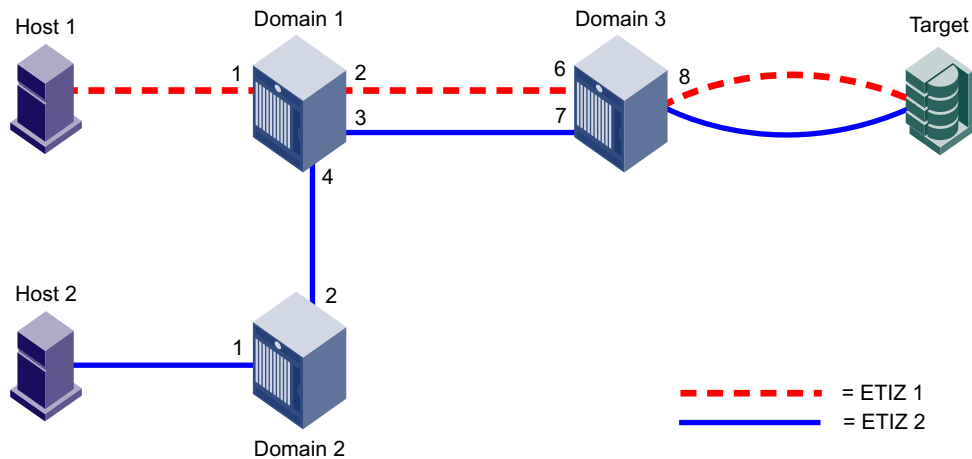

**FIGURE 39** Illegal ETIZ configuration

The Fabric OS routing implementation does not support separate routes to separate ports on a destination domain. Configurations such as this should be avoided.

See [“Additional configuration rules for enhanced TI zones”](#) on page 278 for more information about enhanced TI zones.

## Traffic Isolation Zoning over FC routers

This section describes how TI zones work with Fibre Channel routing (TI over FCR). See [Chapter 21, “Using the FC-FC Routing Service,”](#) for information about FC routers, phantom switches, and the FC-FC Routing Service.

Some VE\_Port-based features, such as tape pipelining, require the request and corresponding response traffic to traverse the same VE\_Port tunnel across the metaSAN. To ensure that the request and response traverse the same VE\_Port tunnel, you must set up Traffic Isolation zones in the edge and backbone fabrics.

- Set up a TI zone in an edge fabric to guarantee that traffic from a specific device in that edge fabric is routed through a particular EX\_Port or VEX\_Port.
- Set up a TI zone in the backbone fabric to guarantee that traffic between two devices in different fabrics is routed through a particular ISL (VE\_Ports or E\_Ports) in the backbone.

This combination of TI zones in the backbone and edge fabrics ensures that the traffic between devices in different fabrics traverses the same VE\_Port tunnel in a backbone fabric. [Figure 40](#) shows how three TI zones form a dedicated path between devices in different edge fabrics. The backbone fabric can contain one or more FC routers.

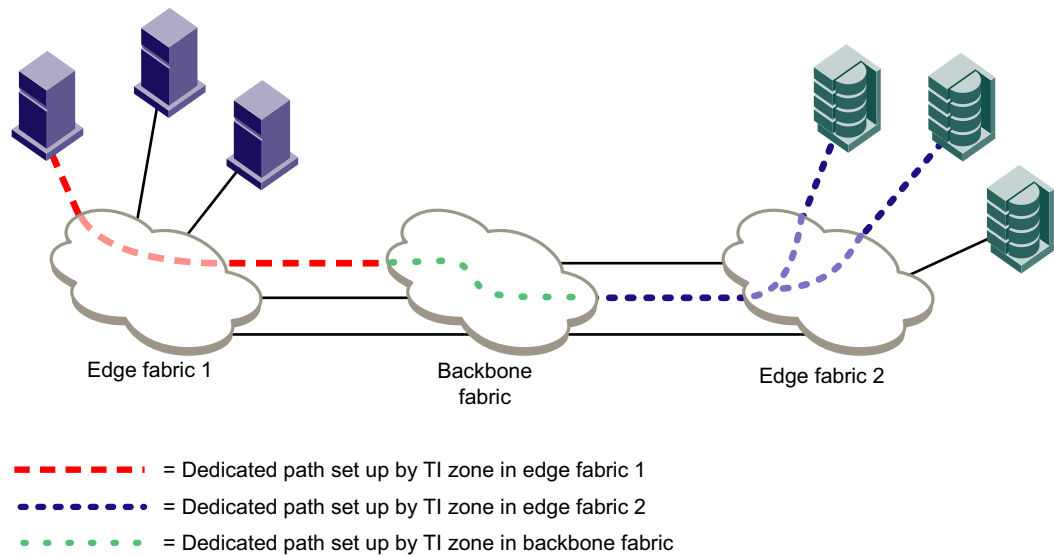

**FIGURE 40** Traffic Isolation Zoning over FCR

In addition to setting up TI zones, you must also ensure that the devices are in an LSAN zone so that they can communicate with each other.

If failover is enabled and the TI path is not available, an alternate path is used. If failover is disabled and the TI path is not available, then devices are not imported.

**NOTE**

For TI over FCR, all switches in the backbone fabric and in the edge fabrics must be running Fabric OS v6.1.0 or later.

**TI within an edge fabric**

A TI zone within an edge fabric is used to route traffic between a real device and a proxy device through a particular EX\_Port. For example, in [Figure 41](#), you can set up a TI zone to ensure that traffic between Host 1 and the proxy target is routed through EX\_Port 9.

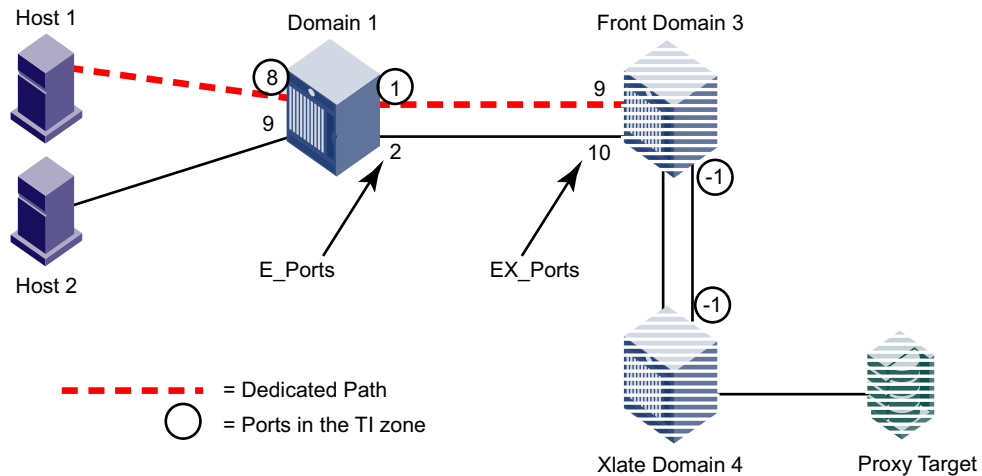

**FIGURE 41** TI zone in an edge fabric

In the TI zone, when you designate E\_Ports between the front and xlate phantom switches, you must use -1 in place of the “1” in the D,I notation. Both the front and xlate domains must be included in the TI zone.

Using D,I notation, the members of the TI zone in Figure 41 are:

- 1,8
- 1,1
- 3,-1 (E\_Port for the front phantom domain)
- 4,-1 (E\_Port for the xlate phantom domain)

Note that in this configuration the traffic between the front and xlate domains can go through any path between these two domains. The -1 does not identify any specific ISL. To guarantee a specific ISL, you need to set up a TI zone within the backbone fabric.

### TI within a backbone fabric

A TI zone within a backbone fabric is used to route traffic within the backbone fabric through a particular ISL. For example, in Figure 42, a TI zone is set up in the backbone fabric to ensure that traffic between EX\_Ports “1,1” and “2,1” is routed through VE\_Ports “1,4” and “2,7”.

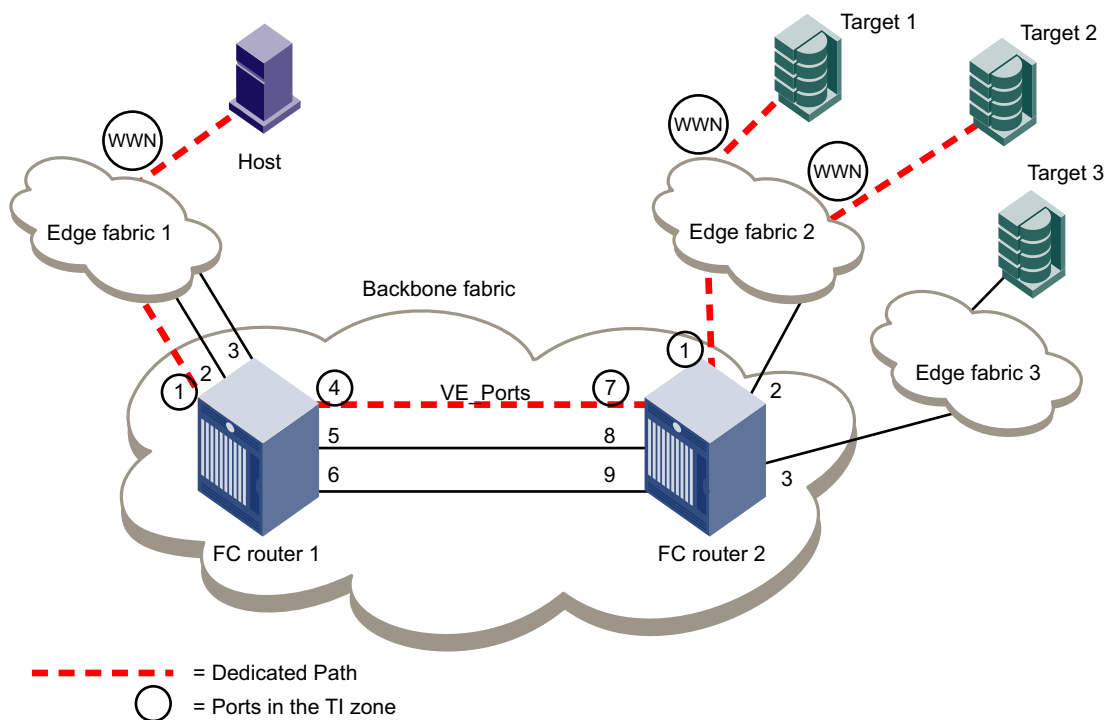

FIGURE 42 TI zone in a backbone fabric

TI zones within the backbone fabric use the port WWN instead of D,I notation for devices that are to communicate across fabrics. (You can use the **portShow** command to obtain the port WWN.) Port WWNs should be used only in TI zones within a backbone fabric and should not be used in other TI zones.

Using D,I and port WWN notation, the members of the TI zone in [Figure 42](#) are:

1,1	(EX_Port for FC router 1)
1,4	(VE_Port for FC router 1)
2,7	(VE_Port for FC router 2)
2,1	(EX_Port for FC router 2)
10:00:00:00:00:01:00:00	(Port WWN for the host)
10:00:00:00:00:02:00:00	(Port WWN for target 1)
10:00:00:00:00:03:00:00	(Port WWN for target 2)

### Limitations of TI zones over FC routers

Be aware of the following when configuring TI zones over FC routers:

- A TI zone defined within the backbone fabric does not guarantee that edge fabric traffic will arrive at a particular EX\_Port. You must set up a TI zone in the edge fabric to guarantee this.
- TI zones within the backbone fabric cannot contain more than one destination router port (DRP) per each fabric.
- Only one egress E\_Port or VE\_Port connected to the next hop can be defined within TI zones.
- TI over FCR is supported only from edge fabric to edge fabric. Traffic isolation from backbone to edge is not supported.
- Non-TI data traffic is *not* restricted from going through the TI path in the backbone fabric.
- For TI over FCR, failover must be enabled in the TI zones in the edge fabrics. The failover mode for TI zones in the backbone fabric can be enabled or disabled.
- TI over FCR is not supported with FC Fast Write.

## General rules for TI zones

Note the following general rules for TI zones:

- A TI zone must include E\_Ports and N\_Ports that form a complete, end-to-end route from initiator to target.
- When an E\_Port is a member of a TI zone that E\_Port cannot have its indexed swapped with another port.
- A given E\_Port used in a TI zone should not be a member of more than one TI zone.  
If multiple E\_Ports are configured that are on the lowest cost route to a domain, the various source ports for that zone are load-balanced across the specified E\_Ports.
- TI zones reside only in the defined configuration and not in the effective configuration. When you make any changes to TI zones, including creating or modifying them, you must enable the effective configuration for the changes to take effect, even if the effective configuration is unchanged.
- A TI zone only provides traffic isolation and is not a “regular” zone.
- Routing rules imposed by TI zones with failover disabled override regular zone definitions. Regular zone definitions should match TI zone definitions.
- Each TI zone is interpreted by each switch and each switch considers only the routing required for its local ports. No consideration is given to the overall topology and to whether the TI zones accurately provide dedicated paths through the whole fabric.

For example, in Figure 43, the TI zone was configured incorrectly and E\_Port “3,9” was erroneously omitted from the zone. The domain 3 switch assumes that traffic coming from E\_Port 9 is *not* part of the TI zone and so that traffic is routed to E\_Port 11 instead of E\_Port 12, if failover is enabled. If failover is disabled, the route is broken and traffic stops.

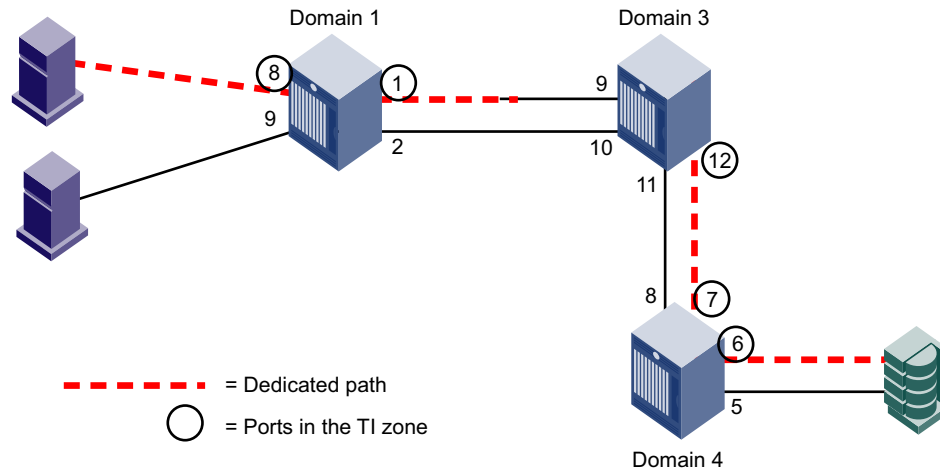

FIGURE 43 TI zone misconfiguration

## Supported configurations for Traffic Isolation Zoning

Note the following configuration rules for TI zones:

- TI Zoning is supported in Brocade Native Mode (interopmode 0) and in a mixed fabric (that is, a fabric with Fabric OS and M-EOS switches) operating in interopmode 2. TI Zoning is *not* supported in fabrics configured in Open Fabric Mode (interopmode 3).
- Ports in a TI zone must belong to switches that run Fabric OS v6.0.0 or later. For TI over FCR zones, ports must belong to switches that run Fabric OS v6.1.0 or later.
- For the FC8-64 blade in the Brocade DCX, ports 48–63 can be in a TI zone only if all switches in that TI zone are running Fabric OS v6.4.0 or later. Ports 48–63 can still be in a failover path for TI traffic. The Brocade DCX-4S does not have this limitation.
- TI Zoning has limited support for FICON, FCIP in McDATA Fabric Mode (interopmode 2), in the following configuration only:
  - Brocade 7500 with E\_Port connections to an M-switch and VE\_Port connections to another Brocade 7500.
  - Devices attached to M-switch only.

Following is a sample configuration:

Devices — M-switch — Brocade 7500 — Brocade 7500 — M-switch — Devices

- In interopmode 2, a zone member for a TI zone is limited to a port index of 255 or less.
- VE\_Ports are supported in TI zones.
- TI Zoning is not supported in fabrics with switches running firmware versions earlier than Fabric OS v6.0.0. However, the existence of a TI zone in such a fabric is backward-compatible and does not disrupt fabric operation in switches running earlier firmware versions.

TI over FCR is not backward compatible with Fabric OS v6.0.x or earlier. The -1 in the *domain,index* entries causes issues to legacy switches in a zone merge. Firmware downgrade is prevented if TI over FCR zones exist.

### Additional configuration rules for enhanced TI zones

Enhanced TI zones (ETIZ) have the following additional configuration rules:

- Enhanced TI zones are supported only on the following platforms: Brocade 300, 5100, 5300, 5410, 5424, 5450, 5460, 5470, 5480, 7800, 8000, VA-40FC, DCX, DCX-4S, and Brocade Encryption Switch.  
Enhanced TI zones are *not* supported on the Brocade 4100, 4900, 5000, 7500, 7500E, 7600, and 48000.
- Enhanced TI zones are supported only if every switch in the fabric is ETIZ capable. A switch is ETIZ capable if it meets the following qualifications:
  - The switch must be one of the supported platforms, as listed above.
  - The switch must be running Fabric OS v6.4.0 or later.
- If the fabric contains a switch running an earlier version of Fabric OS, you cannot create an enhanced TI zone. You cannot merge a downlevel switch into a fabric containing enhanced TI zones, and you cannot merge a switch with enhanced TI zones defined into a fabric containing switches that do not support ETIZ.

---

#### NOTE

FC router domains and EOS switches are excluded from the ETIZ platform restrictions. You can create enhanced TI zones with these switches in the fabric.

---

### Trunking with TI zones

Note the following if you implement trunking and TI zones:

- To include a trunk group in a TI zone, you must include all ports of the trunk in the TI zone.
- Trunked ISL ports cannot be members of more than one TI zone.

## Limitations and restrictions of Traffic Isolation Zoning

The following are limitations of TI zones:

- For switches running Fabric OS 6.1.0 or later, a maximum of 255 TI zones can be created in one fabric. For switches running Fabric OS 6.0.x, no more than 239 TI zones should be created.  
A fabric merge resulting in greater than the maximum allowed TI zones results in merge failure and the fabrics are segmented.
- A TI zone can be created using D,I (Domain, Index) notation only, except for TI zones in a backbone fabric, which use port WWNs. See [“Traffic Isolation Zoning over FC routers”](#) for information about TI zones in a backbone fabric.
- To include a trunk group in a TI zone, you must include all ports of the trunk in the TI zone.

- Two N\_Ports that have the same shared area should not be configured in different TI zones. This limitation does not apply to E\_Ports that use the same shared area on the FC4-48 and FC8-48 port blades.
- Ports that are in different TI zones cannot communicate with each other if failover is disabled.
- TI zone members that overlap must have the same TI failover policy across all TI zones to which they belong. That is, if an overlapping member is part of a failover-disabled zone, then it can belong only to other TI zones where the policy is also failover-disabled; the member cannot overlap with failover-enabled TI zones.
- TI zones that have members with port index greater than 511 are not supported with Fabric OS versions earlier than v6.4.0. If such a TI zone and Fabric OS version combination is detected, a warning is issued. These configurations are not prevented, but their behavior is unpredictable.

## Admin Domain considerations for Traffic Isolation Zoning

Note the following if you implement Admin Domains and TI zones:

- TI zones are applicable only in ADO, and the E\_Ports that are members of a TI zone must be in the ADO device list. Because TI zones must use D,I notation, the ADO device list must be declared using D,I notation for ports that are to be used in TI zones.
- A port used in a TI zone should not be a member of multiple Admin Domains.
- Use care if defining TI zones with ports that are shared across Admin Domains because of the limitation that a given port can appear in only one TI zone.  
**Best practice:** Do not use ports that are shared across Admin Domains in a TI zone.

## Virtual Fabric considerations for Traffic Isolation Zoning

This section describes how TI zones work with Virtual Fabrics. See [Chapter 10, “Managing Virtual Fabrics,”](#) for information about the Virtual Fabrics feature, including logical switches and logical fabrics.

TI zones can be created in a logical fabric like in regular fabrics, with the following exceptions:

- The disable failover option is not supported in logical fabrics that use XISLs.  
Although logical switches that use XISLs allow the creation of a TI zone with failover disabled, this is not a supported configuration. Base switches do not allow the creation of a TI zone with failover disabled.
- To create a TI zone for a logical fabric that uses XISLs, you must create two TI zones: one in the logical fabric and one in the base fabric. The combination of TI zones in the base fabric and logical fabric sets the path through the base fabric for logical switches.

The TI zone in the logical fabric includes the extended XISL (XISL) port numbers, as well as the F\_Ports and ISLs in the logical fabric.

The TI zone in the base fabric reserves XISLs for a particular logical fabric. The base fabric TI zone should also include ISLs that belong to logical switches participating in the logical fabric.

[Figure 44](#) shows an initiator and target in a logical fabric (FID1). The dotted line indicates a dedicated path between initiator and target. The dedicated path passes through the base fabric over an XISL. ([Figure 44](#) shows only physical ISLs, not logical ISLs.) To create the TI zones for this dedicated path, you must create a TI zone in the logical fabric (FID 1) and one in the base fabric.

## 12 Virtual Fabric considerations for Traffic Isolation Zoning

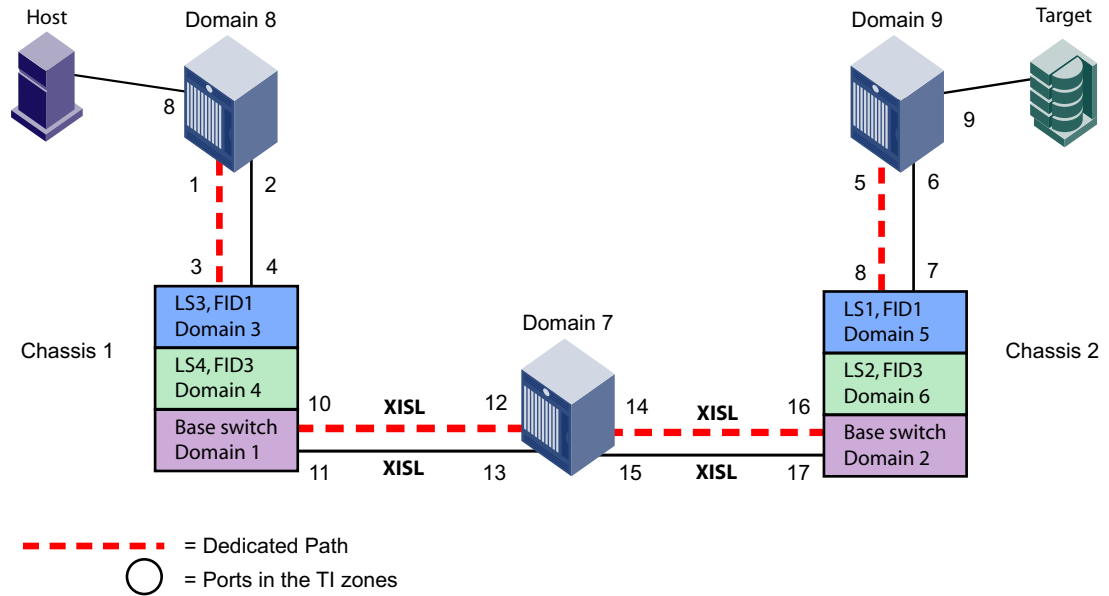

**FIGURE 44** Dedicated path with Virtual Fabrics

Figure 45 shows a logical representation of FID1 in Figure 44. To create the dedicated path, you must create and activate a TI zone in FID1 that includes the circled ports shown in Figure 45.

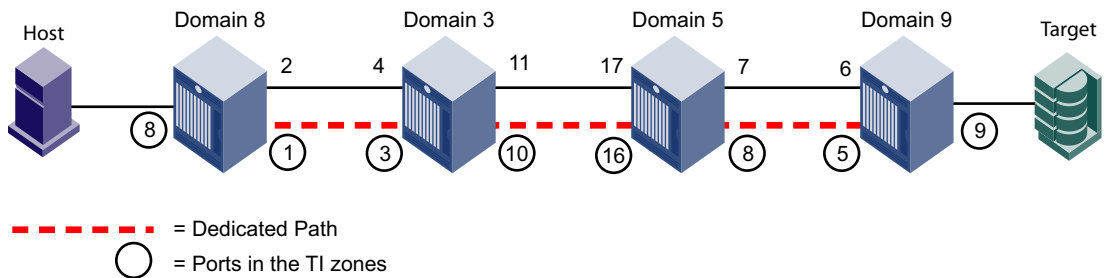

**FIGURE 45** Creating a TI zone in a logical fabric

You must also create and activate a TI zone in the base fabric to reserve the XISLs for the dedicated path. In Figure 44, the XISLs highlighted (by a dotted line) in the base fabric can be reserved for FID1 by defining and activating a base fabric TI zone that consists of ports 10, 12, 14, and 16. You must also include ports 3 and 8, because they belong to logical switches participating in the logical fabric. For the TI zone, it is as though ports 3 and 8 belong to Domains 1 and 2 respectively.

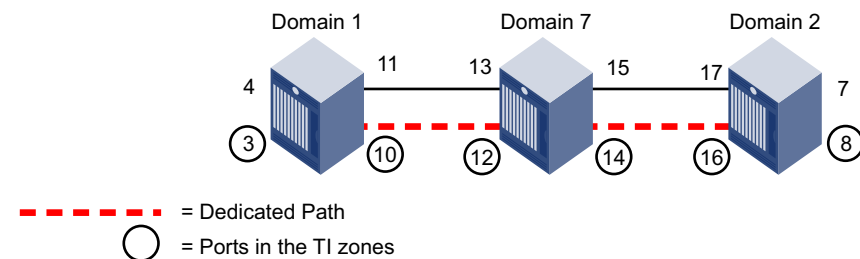

**FIGURE 46** Creating a TI zone in a base fabric



Using D,I notation, the port numbers for the TI zones in the logical fabric and base fabric are as follows:

**Port members for the TI zone in logical fabric**

- 8,8 F\_Port
- 8,1 E\_Port
- 3,3 E\_Port
- 3,10 E\_Port
- 5,16 E\_Port
- 5,8 E\_Port
- 9,5 E\_Port
- 9,9 F\_Port

**Port members for the TI zone in base fabric**

- 1,3 E\_Port for ISL in logical switch
- 1,10 E\_Port for XISL
- 7,12 E\_Port for XISL
- 7,14 E\_Port for XISL
- 2,16 E\_Port for XISL
- 2,8 E\_Port for ISL in logical switch

Note that the base fabric zone contains a reference to port 1,3 even though the base switch with domain 1 does not have a port 3 in the switch. This number refers to the port in the chassis with port index 3, which actually belongs to LS3 in FID 1.

## Traffic Isolation Zoning over FC routers with Virtual Fabrics

This section describes how you can set up TI zones over FC routers in logical fabrics. [Figure 47](#) shows two physical chassis configured into logical switches. The initiator in FID 1 communicates with the target in FID 3 over the EX\_Ports in the base switches.

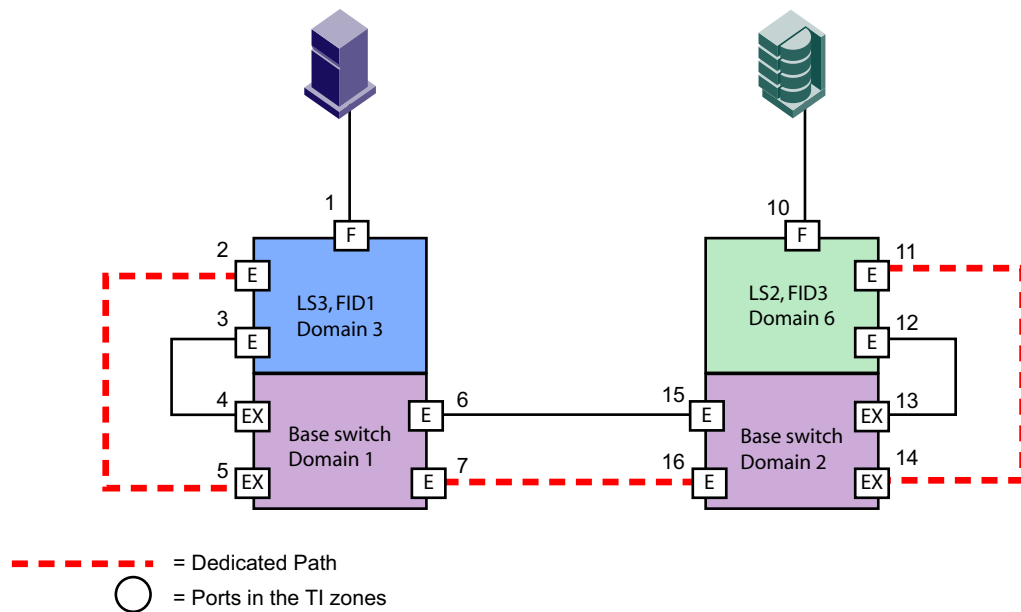

**FIGURE 47** Example configuration for TI zones over FC routers in logical fabrics

[Figure 48](#) shows a logical representation of the configuration in [Figure 47](#). This SAN is similar to that shown in [Figure 40](#) on page 274 and you would set up the TI zones in the same way as described in “[Traffic Isolation Zoning over FC routers](#)” on page 273.

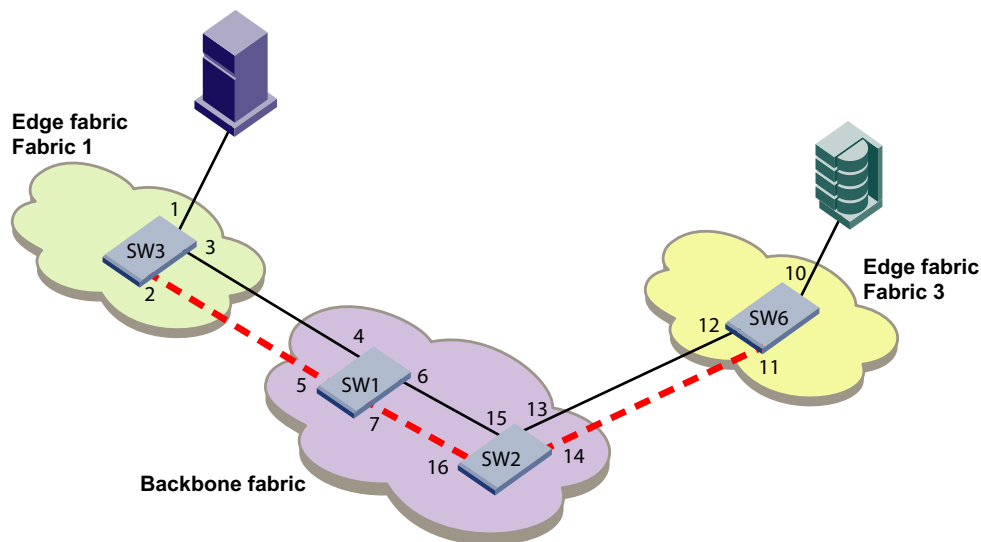

FIGURE 48 Logical representation of TI zones over FC routers in logical fabrics

## Creating a TI zone

You create and modify TI zones using the **zone** command. Other zoning commands, such as **zoneCreate**, **aliCreate**, and **cfgCreate**, cannot be used to manage TI zones.

When you create a TI zone, you can set the state of the zone to activated or deactivated. By default the zone state is set to activated; however, this does not mean that the zone is activated. After you create the TI zone, you must enable the current effective configuration to enforce the new TI zone, which is either activated or deactivated.

**Virtual Fabric considerations:** Because base fabrics do not contain end devices, they normally do not have an effective zone configuration. To activate a TI zone in a base fabric, you should create a "dummy" configuration, as described in ["Creating a TI zone in a base fabric"](#) on page 284.

When you create a TI zone, you can enable or disable failover mode. By default, failover mode is enabled. If you want to change the failover mode after you create the zone, see ["Modifying TI zones"](#) on page 284.

If you are creating a TI zone with failover disabled, note the following:

- Ensure that the E\_Ports of the TI zone correspond to valid paths; otherwise, the route might be missing for ports in that TI zone. You can use the **topologyShow** command to verify the paths.
- Ensure that sufficient non-dedicated paths through the fabric exist for all devices that are not in a TI zone; otherwise, these devices might become isolated.

See ["TI zone failover"](#) on page 268 for information about disabling failover mode.

Use the following procedure to create a TI zone. If you are creating a TI zone in a base fabric, use the procedure described in ["Creating a TI zone in a base fabric"](#) on page 284.

1. Connect to the switch and log in as admin.
2. Enter the **zone --create** command:

```
zone --create -t objtype [-o optlist] name -p "portlist"
```

Be aware of the ramifications if you create a TI zone with failover mode disabled. See [“TI zone failover”](#) on page 268 for information about disabling failover mode.

3. Enter the **cfgEnable** command to reactivate your current effective configuration and enforce the TI zones.

```
cfgenable "current_effective_configuration"
```

#### Example of creating a TI zone

The following examples create a TI zone named “bluezone”, which contains E\_Ports 1,1 and 2,4 and N\_Ports 1,8 and 2,6.

To create a TI zone with failover enabled and in the activated state (default settings):

```
switch:admin> zone --create -t ti bluezone -p "1,1; 2,4; 1,8; 2,6"
```

To create a TI zone with failover enabled (the zone is set to the activated state by default):

```
switch:admin> zone --create -t ti -o f bluezone -p "1,1; 2,4; 1,8; 2,6"
```

To create a TI zone with failover disabled and the state set to activated:

```
switch:admin> zone --create -t ti -o an bluezone -p "1,1; 2,4; 1,8; 2,6"
```

To create a TI zone and set the state to deactivated (failover is enabled by default):

```
switch:admin> zone --create -t ti -o d bluezone -p "1,1; 2,4; 1,8; 2,6"
```

To create a TI zone with failover disabled and the state set to deactivated:

```
switch:admin> zone --create -t ti -o dn bluezone -p "1,1; 2,4; 1,8; 2,6"
```

To create a TI zone in the edge fabric with failover enabled and the state set to activated (default settings):

```
switch:admin> zone --create -t ti bluezone -p "1,1; 1,8; 2,-1; 3,-1"
```

To create a TI zone in the backbone fabric with failover enabled and the state set to activated (default settings):

```
switch:admin> zone --create -t ti backbonezone -p "10:00:00:04:1f:03:16:f2; 1,1; 1,4; 2,7; 2,1; 10:00:00:04:1f:03:18:f1, 10:00:00:04:1f:04:06:e2"
```

To create TI zones in a logical fabric, such as the one shown in [Figure 45](#) on page 280:

Log in to the logical switch FID1, Domain 7 and create a TI zone in the logical fabric with FID=1:

```
LS1> zone --create -t ti -o f "ti_zone1" -p "8,8; 8,1; 3,3; 3,10; 5,16; 5,8; 9,5; 9,9"
```

Then create a TI zone in the base fabric, as described in [“Creating a TI zone in a base fabric”](#).

Remember that your changes are not enforced until you enter the **cfgEnable** command, as shown here:

```
switch:admin> cfgenable "USA_cfg"
You are about to enable a new zoning configuration.
This action will replace the old zoning configuration with the
current configuration selected.
If the update includes changes to one or more traffic isolation zones, the
update may result in localized disruption to traffic on ports associated with
the traffic isolation zone changes
Do you want to enable 'USA_cfg' configuration (yes, y, no, n): [no] y
zone config "USA_cfg" is in effect
Updating flash ...
```

## Creating a TI zone in a base fabric

1. Connect to the switch and log in as admin.
2. Create a “dummy” zone configuration in the base fabric. For example:

```
zone --create "z1", "1,1"
cfgcreate "base_config", z1
```

3. Enter the **zone --create** command to create the TI zone in the base fabric:

```
zone --create -t objtype -o f name -p "portlist"
```

The disable failover option is not supported in base fabrics.

4. Enter the **cfgEnable** command to reactivate your current effective configuration and enforce the TI zones.

```
cfgenable "base_config"
```

### Example

The following example creates TI zones in the base fabric shown in [Figure 46](#) on page 280:

```
BS_D1> zonecreate "z1", "1,1"
BS_D1> cfgcreate "base_cfg", z1
BS_D1> zone --create -t ti -o f "ti_zone2" -p "1,3; 1,10; 7,12; 7,14; 2,16;
2,8"
BS_D1> cfgenable "base_config"
```

## Modifying TI zones

Using the **zone --add** command, you can add ports to an existing TI zone, change the failover option, or both. You can also activate or deactivate the TI zone.

Using the **zone --remove** command, you can remove ports from existing TI zones. If you remove the last member of a TI zone, the TI zone is deleted.

After you modify the TI zone, you must enable the current effective configuration to enforce the changes.

---

### ATTENTION

If failover is disabled, do not allocate all ISLs in TI zones. Make sure sufficient non-dedicated paths exist through the fabric for all devices that are not in a TI zone. See [“TI zone failover”](#) on page 268 for additional information about disabling failover mode.

---

1. Connect to the switch and log in as admin.
2. Enter one of the following commands, depending on how you want to modify the TI zone.
  - Enter the **zone --add** command to add ports or change the failover option for an existing TI zone. You can also activate or deactivate the zone.

```
zone --add [-o optlist] name -p "portlist"

zone --add -o optlist name [-p "portlist"]
```
  - Enter the **zone --remove** command to remove ports from an existing TI zone.

```
zone --remove name -p "portlist"
```

Be aware of the ramifications if you disable failover mode. See [“TI zone failover”](#) on page 268 for information about disabling failover mode.

3. Enter the **cfgEnable** command to reactivate your current effective configuration and enforce the TI zones.

```
cfgenable "current_effective_configuration"
```

#### Example of modifying a TI zone

To add port members to the existing TI zone bluezone:

```
switch:admin> zone --add bluezone -p "3,4; 3,6"
```

To add port members to the existing TI zone in a backbone fabric:

```
switch:admin> zone --add backbonezone -p "3,4; 3,6; 10:00:00:04:1f:03:16:f2;"
```

To disable failover on the existing TI zone bluezone:

```
switch:admin> zone --add -o n bluezone
```

To enable failover and add ports to TI zone greenzone:

```
switch:admin> zone --add -o f greenzone -p "3,4"
```

To remove ports from the TI zone bluezone:

```
switch:admin> zone --remove bluezone -p "3,4; 3,6"
```

Remember that your changes are not enforced until you enter the **cfgEnable** command.

## Changing the state of a TI zone

You can change the state of a TI zone to activated or deactivated. Changing the state does not activate or deactivate the zone. After you change the state of the TI zone, you must enable the current effective configuration to enforce the change.

The TI zone must exist before you can change its state.

1. Connect to the switch and log in as admin.
2. Perform one of the following actions:
  - To activate a TI zone, enter the **zone --activate** command.
 

```
zone --activate name
```
  - To deactivate a TI zone, enter the **zone --deactivate** command.
 

```
zone --deactivate name
```
3. Enter the **cfgEnable** command to reactivate your current effective configuration and enforce the TI zones.

```
cfgenable "current_effective_configuration"
```

#### Example of setting the state of a TI zone

To change the state of the existing TI zone bluezone to activated, type:

```
switch:admin> zone --activate bluezone
```

To change the state of the existing TI zone greenzone to deactivated, type:

```
switch:admin> zone --deactivate greenzone
```

Remember that your changes are not enforced until you enter the **cfgEnable** command.

## Deleting a TI zone

Use the **zone --delete** command to delete a TI zone from the defined configuration. This command deletes the entire zone; to only remove port members from a TI zone, use the **zone --remove** command, as described in “Modifying TI zones” on page 284.

1. Connect to the switch and log in as admin.
2. Enter the **zone --delete** command.

```
zone --delete name
```

You can delete multiple zones by separating the zone names with a semicolon and enclosing them in quotation marks.

3. Enter the **cfgEnable** command to reactivate your current effective configuration and enforce the TI zones.

```
cfgenable "current_effective_configuration"
```

### Example of deleting a TI zone

To delete the TI zone bluezone, type:

```
switch:admin> zone --delete bluezone
```

Remember that your changes are not enforced until you enter the **cfgEnable** command.

## Displaying TI zones

Use the **zone --show** command to display information about TI zones. This command displays the following information for each zone:

- zone name
- E\_Port members
- N\_Port members
- configured status (the latest status, which may or may not have been activated by **cfgEnable**)
- enabled status (the status that has been activated by **cfgEnable**)

If you enter the **cfgShow** command to display information about all zones, the TI zones appear in the defined zone configuration only and do not appear in the effective zone configuration.

1. Connect to the switch and log in as admin.
2. Enter the **zone --show** command.

```
zone --show [ name ] [-ascending]
```

To display information about the TI zone purplezone:

```
switch:admin> zone --show purplezone
Defined TI zone configuration:
```

```
TI Zone Name:   redzone:
Port List:      1,2; 1,3; 3,3; 4,5
```

```
Configured Status: Activated / Failover-Enabled
Enabled Status: Activated / Failover-Enabled
```

To display information about all TI zones in the defined configuration in ascending order:

```
switch:admin> zone --show -ascending
Defined TI zone configuration:

TI Zone Name:  bluezone:
Port List:     8,3; 8,5; 9,2; 9,3;

Configured Status: Deactivated / Failover-Disabled
Enabled Status:  Activated / Failover-Enabled

TI Zone Name:  greenzone:
Port List:     2,2; 3,3; 4,11; 5,3;

Configured Status: Activated / Failover-Enabled
Enabled Status:  Activated / Failover-Enabled

TI Zone Name:  purplezone:
Port List:     1,2; 1,3; 3,3; 4,5;

Configured Status: Activated / Failover-Enabled
Enabled Status:  Deactivated / Failover-Enabled
```

## Setting up TI over FCR (sample procedure)

The following example shows how to set up TI zones over FCR to provide a dedicated path shown in [Figure 49](#). In this example, three TI zones are created: one in each of the edge fabrics and one in the backbone fabric. The combination of these three TI zones creates a dedicated path for traffic between Host 1 in edge fabric 1 and Targets 1 and 2 in edge fabric 2.

Host 1 has port WWN 10:00:00:00:00:08:00:00

Target 1 has port WWN 10:00:00:00:00:02:00:00

Target 2 has port WWN 10:00:00:00:00:03:00:00

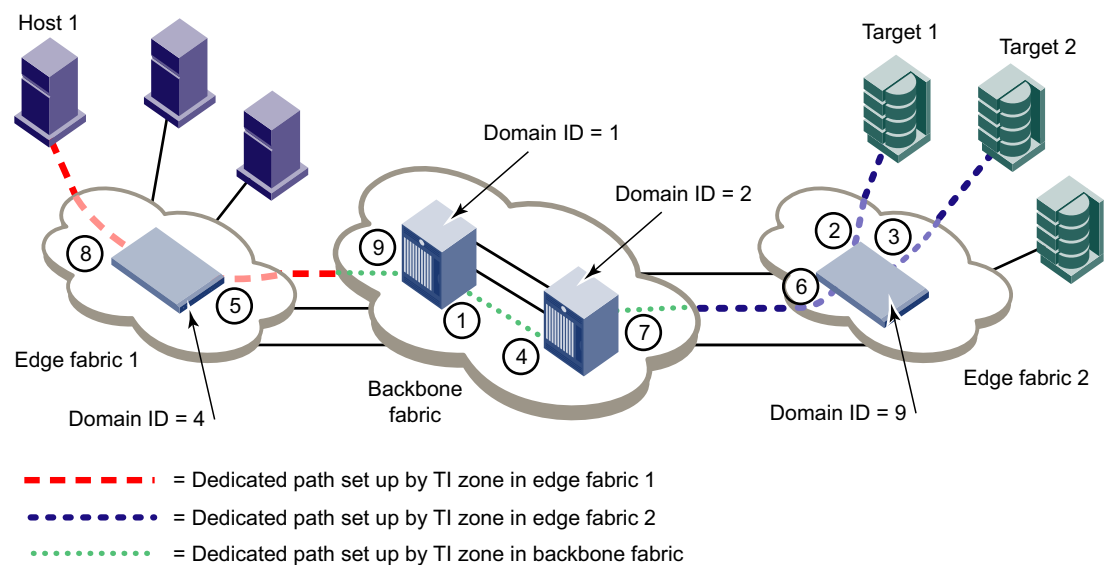

FIGURE 49 TI over FCR example

---

## NOTE

In the following procedure the three TI zones in the edge and backbone fabrics are all given the same name, TI\_Zone1. It is not required that the TI zones have the same name, but this is done to avoid confusion. If several dedicated paths are set up across the FC router, the TI zones for each path can have the same name.

---

1. In each edge fabric, set up an LSAN zone that includes Host 1, Target 1, and Target 2, so these devices can communicate with each other. See [Chapter 21, "Using the FC-FC Routing Service,"](#) for information about creating LSAN zones.
2. Log in to the edge fabric 1 and set up the TI zone.
  - a. Enter the **fabricShow** command to display the switches in the fabric. From the output, you can determine the front and translate domains.

```
Elswitch:admin> fabricshow
Switch ID      Worldwide Name          Enet IP Addr    FC IP Addr      Name
-----
1: fffc01 50:00:51:e3:95:36:7e:04 0.0.0.0         0.0.0.0         "fcr_fd_1"
4: fffc04 10:00:00:60:69:80:1d:bc 10.32.72.4      0.0.0.0         >"Elswitch"
6: fffc06 50:00:51:e3:95:48:9f:a0 0.0.0.0         0.0.0.0         "fcr_xd_6_9"
```

The Fabric has 3 switches

- b. Enter the following commands to create and display a TI zone:

```
Elswitch:admin> zone --create -t ti TI_Zone1 -p "4,8; 4,5, 1,-1; 6,-1"
Elswitch:admin> zone --show
Defined TI zone configuration:
```

```
TI Zone Name:  TI_Zone1
Port List:     4,8; 4,5; 1,-1; 6,-1

Status: Activated      Failover: Enabled
```

- c. Enter the following commands to reactivate your current effective configuration and enforce the TI zones.

```
Elswitch:admin> cfgactvshow

Effective configuration:
cfg:  cfg_TI
zone:  lsan_t_i_TI_Zone1
      10:00:00:00:00:00:02:00:00
      10:00:00:00:00:00:03:00:00
      10:00:00:00:00:00:08:00:00
```

```
Elswitch:admin> cfgenable cfg_TI
You are about to enable a new zoning configuration.
This action will replace the old zoning configuration with the
current configuration selected.
If the update includes changes to one or more traffic isolation zones, the
update may result in localized disruption to traffic on ports associated
with the traffic isolation zone changes
Do you want to enable 'cfg_TI' configuration (yes, y, no, n): [no] y
zone config "cfg_TI" is in effect
Updating flash ...
```



### 3. Log in to the edge fabric 2 and set up the TI zone.

- a. Enter the **fabricShow** command to display the switches in the fabric. From the output, you can determine the front and translate domains.

```
E2switch:admin> fabricshow
Switch ID    Worldwide Name          Enet IP Addr    FC IP Addr      Name
-----
1: fffc01 50:00:51:e3:95:36:7e:09 0.0.0.0         0.0.0.0         "fcr_fd_1"
4: fffc04 50:00:51:e3:95:48:9f:a1 0.0.0.0         0.0.0.0         "fcr_xd_6_9"
9: fffc09 10:00:00:05:1e:40:f0:7d 10.32.72.9     0.0.0.0         >"E2switch"
```

The Fabric has 3 switches

- b. Enter the following commands to create and display a TI zone:

```
E2switch:admin> zone --create -t ti TI_Zone1 -p "9,2; 9,3; 9,6; 1,-1; 4,-1"
E2switch:admin> zone --show
Defined TI zone configuration:
```

```
TI Zone Name:  TI_Zone1
Port List:     9,2; 9,3; 9,6; 1,-1; 4,-1
```

```
Status: Activated      Failover: Enabled
```

- c. Enter the following commands to reactivate your current effective configuration and enforce the TI zones.

```
E2switch:admin> cfgactvshow
```

Effective configuration:

```
cfg:  cfg_TI
zone:  lsan_t_i_TI_Zone1
      10:00:00:00:00:00:02:00:00
      10:00:00:00:00:00:03:00:00
      10:00:00:00:00:00:08:00:00
```

```
E2switch:admin> cfgenable cfg_TI
```

You are about to enable a new zoning configuration.

This action will replace the old zoning configuration with the current configuration selected.

If the update includes changes to one or more traffic isolation zones, the update may result in localized disruption to traffic on ports associated with the traffic isolation zone changes

Do you want to enable 'cfg\_TI' configuration (yes, y, no, n): [no] **y**

zone config "cfg\_TI" is in effect

Updating flash ...

### 4. Log in to the backbone fabric and set up the TI zone.

- a. Enter the following commands to create and display a TI zone:

```
BB_DCX_1:admin> zone --create -t ti TI_Zone1 -p "1,9; 1,1; 2,4; 2,7;
10:00:00:00:00:08:00:00; 10:00:00:00:00:02:00:00; 10:00:00:00:00:03:00:00"
BB_DCX_1:admin> zone --show
Defined TI zone configuration:
```

```
TI Zone Name:  TI_Zone1
Port List:     1,9; 1,1; 2,4; 2,7; 10:00:00:00:00:08:00:00;
10:00:00:00:00:02:00:00; 10:00:00:00:00:03:00:00
```

```
Status: Activated      Failover: Enabled
```

## 12 Setting up TI over FCR (sample procedure)

- b. Enter the following commands to reactivate your current effective configuration and enforce the TI zones.

```
BB_DCX_1:admin> cfgactvshow
```

```
Effective configuration:
```

```
cfg:   cfg_TI
zone:  lsan_t_i_TI_Zone1
      10:00:00:00:00:00:02:00:00
      10:00:00:00:00:00:03:00:00
      10:00:00:00:00:00:08:00:00
```

```
BB_DCX_1:admin> cfgenable cfg_TI
```

```
You are about to enable a new zoning configuration.
```

```
This action will replace the old zoning configuration with the
current configuration selected.
```

```
If the update includes changes to one or more traffic isolation zones, the
update may result in localized disruption to traffic on ports associated
with the traffic isolation zone changes
```

```
Do you want to enable 'cfg_TI' configuration (yes, y, no, n): [no] y
```

```
zone config "cfg_TI" is in effect
```

```
Updating flash ...
```

# Administering NPIV

---

## In this chapter

- [NPIV overview](#) ..... 291
- [Configuring NPIV](#) ..... 293
- [Enabling and disabling NPIV](#) ..... 294
- [Viewing NPIV port configuration information](#) ..... 294

## NPIV overview

N\_Port ID Virtualization (NPIV) enables a single Fibre Channel protocol port to appear as multiple, distinct ports, providing separate port identification within the fabric for each operating system image behind the port (as if each operating system image had its own unique physical port). NPIV assigns a different virtual port ID to each Fibre Channel protocol device. NPIV is designed to enable you to allocate virtual addresses without affecting your existing hardware implementation. The virtual port has the same properties as an N\_Port, and is therefore capable of registering with all services of the fabric. This chapter does not discuss the Access Gateway feature. For more information on the Access Gateway feature, refer to the *Access Gateway Administrator's Guide*.

Each NPIV device has a unique device PID, Port WWN, and Node WWN, and should act the same as all other physical devices in the fabric; in other words, multiple virtual devices emulated by NPIV appear no different than regular devices connected to a non-NPIV port. The same zoning rules apply to NPIV devices as non-NPIV devices. Zones can be defined by *domain,port* notation, by WWN zoning, or both. To perform zoning to the granularity of the virtual N\_Port IDs, you must use WWN-based zoning.

If you are using *domain,port* zoning for an NPIV port, and all the virtual PIDs associated with the port are included in the zone, then a port login (PLOGI) to a non-existent virtual PID is not blocked by the switch; rather, it is delivered to the device attached to the NPIV port. In cases where the device is not capable of handling such unexpected PLOGIs, you should use WWN-based zoning.

The following example shows the number of NPIV devices in the output of the **switchShow** command. The number of NPIV devices is equal to the sum of the base port plus the number of NPIV public devices. The base port is the N\_Port listed in the **switchShow** output. Based on the formula, index 010000 shows only 1 NPIV device and index 010300 shows 222 NPIV devices.

### Example of NPIV devices

```
switch:admin> switchshow
switchName:      5100
switchType:      71.2
switchState:     Online
switchMode:      Access Gateway Mode
switchWwn:       10:00:00:05:1e:41:49:3d
switchBeacon:    OFF

Index Port Address Media Speed State Proto
```

```
=====
0 0 010000 id N4 Online FC F-Port 20:0c:00:05:1e:05:de:e40xa06601
1 1 010100 id N4 Online FC F-Port 1 N Port + 4 NPIV public
2 2 010200 id N4 Online FC F-Port 1 N Port + 119 NPIV public
3 3 010300 id N4 Online FC F-Port 1 N Port + 221 NPIV public
```

On the Brocade DCX and DCX-4S with the FC8-64 blade, the base port is not included in the NPIV device count. The following example shows only 63 NPIV devices total.

```
Index Slot Port Address Media Speed State Proto
=====
127 12 15 a07f40 id N4 Online FC F-Port 1 N Port + 63 NPIV public
(AoQ)
```

## Upgrade considerations

The maximum login per switch has decreased with Fabric OS v6.4.0. When upgrading from Fabric OS pre-v6.4.0, the configured maximum is carried forward and may exceed the v6.4.0 limit. It is recommended to reconfigure this parameter to be within the range permitted in Fabric OS v6.4.0.

## Fixed addressing mode

Fixed addressing mode is the default addressing mode used in all platforms that do not have Virtual Fabrics enabled. When Virtual Fabrics is enabled on the Brocade DCX and DCX-4S, fixed addressing mode is used only on the default partition. The number of NPIV devices supported on shared area ports (48-port blades) is reduced to 64 from 128 when Virtual Fabrics mode is enabled.

## 10-bit addressing mode

The 10-bit addressing mode is the default mode for all the logical switches created in the Brocade DCX and DCX-4S enterprise-class platform. The number of NPIV or loop devices supported on a port is 64.

[Table 53](#) shows the number of NPIV devices supported on the Brocade DCX and DCX-4S enterprise-class platform.

**TABLE 53** Number of supported NPIV devices

Platform	Virtual Fabric	Logical switch type	NPIV support
DCX	Disabled	N/A	Yes, 127 virtual device limit. <sup>1</sup>
DCX	Enabled	Default switch	Yes, 63 virtual device limit. <sup>1</sup>
DCX	Enabled	Logical switch	Yes, 255 virtual device limit. <sup>2, 3</sup>
DCX	Enabled	Base switch	No.
DCX-4S	Disabled	N/A	Yes, 255 virtual device limit.
DCX-4S	Enabled	Default switch	Yes, 255 virtual device limit.

**TABLE 53** Number of supported NPIV devices (Continued)

Platform	Virtual Fabric	Logical switch type	NPIV support
DCX-4S	Enabled	Logical switch	Yes, 255 virtual device limit. <sup>3</sup>
DCX-4S	Enabled	Base switch	No.

1. Maximum limit support takes precedence if user-configured maximum limit is greater. This applies to shared areas on the FC4-48, FC8-48, and FC8-64 port blades.
2. The first 112 physical NPIV-capable devices connected to a logical switch using 10-bit addressing can log in 255 logical devices. The physical NPIV-capable devices after 112, 113, and higher, are limited to 63 logical devices.
3. Maximum limit of 63 for 10-bit areas connected to third-party (non-Brocade) NPIV HBAs.

## Configuring NPIV

The NPIV feature is enabled by default. You can set the number of virtual N\_Port\_IDs per port to a value between 1 and 255 per port. The default setting is 126. To specify the number of virtual N\_Port\_IDs per port on a switch, use the **portCfgNPIVport** command to enable or disable the feature. Once the feature is enabled on the port, you can specify the number of logins per port. If the feature has been disabled, then the NPIV port configuration will not work.

The addressing mode can limit the maximum number of NPIV logins to 127 or 63 depending on the mode. The **portCfgNPIVPort** command can set the maximum number of NPIV login limit to anything from 1 to 255, regardless of the addressing mode. Whichever of these two (addressing mode or the value configured through the **portCfgNPIVPort**) is lower will be the maximum number that can be logged in.



### CAUTION

The **portDisable** command disables the port and stops all traffic flowing to and from the port. Perform this command during a scheduled maintenance.

1. Connect to the switch and log in using an account assigned to the admin role.
2. Enter the **portDisable** command.
3. Enter the **portCfgNPIVPort --setloginlimit** command with the port number and the number of logins per port.
4. Press **Enter**.
5. Enter the **portEnable** command to enable the port.

#### Example of setting the login limit

```
switch:admin> portcfgnpiVport --setloginlimit 1 176
NPIV Limit Set to 176 for Port 1
```

```
switch:admin> portcfgshow 1
Area Number:          1
Speed Level:          AUTO (HW)
Fill Word:             1 (Arbfff-Arbfff)
AL_PA Offset 13:      OFF
Trunk Port             ON
Long Distance         OFF
```

## 13 Enabling and disabling NPIV

```
VC Link Init          OFF
Locked L_Port        OFF
Locked G_Port        OFF
Disabled E_Port      OFF
Locked E_Port        OFF
ISL R_RDY Mode       OFF
RSCN Suppressed      OFF
Persistent Disable    OFF
LOS TOV enable       OFF
NPIV capability      ON
QOS E_Port           OFF
Port Auto Disable:   OFF
Rate Limit           OFF
EX Port              OFF
Mirror Port          OFF
Credit Recovery      ON
F_Port Buffers       OFF
NPIV PP Limit:       176
CSCCTL mode:         OFF
```

### Enabling and disabling NPIV

On the Brocade 300, 4100, 4900, 5000, 5100, 5300, and 8000 switches, the Brocade 5410, 5424, 5450, 5460, 5470, and 5480 embedded switches, the Brocade 48000 director, the Brocade DCX and DCX-4S enterprise-class platforms, and the FA4-18 blade, NPIV is enabled for every port.

---

#### NOTE

CEE/FCoE ports on the Brocade 8000 have NPIV enabled by default, but NPIV cannot be enabled or disabled on these ports. The login limit can be set on these ports provided you disable and enable the ports using the **fcoe --disable** and **fcoe --enable** commands.

---

1. Connect to the switch and log in using an account assigned to the admin role.
2. To enable or disable NPIV on a port, enter the **portCfgNPIVPort** command with either the **--enable** or **--disable** option.

The following example shows NPIV being enabled on port 10 of a Brocade 5100:

```
switch:admin> portCfgNPIVPort --enable 10
```

---

#### NOTE

If the NPIV feature is disabled, the port is toggled if NPIV devices are logged in from that F\_Port (a true NPIV port). Otherwise, the firmware considers that port as an F\_Port even though the NPIV feature was enabled.

---

### Viewing NPIV port configuration information

1. Connect to the switch and log in using an account assigned to the admin role.
2. Enter the **portCfgShow** command to view the switch ports information.

The following example shows whether a port is configured for NPIV:

```
switch:admin> portcfgshow
```

Ports of Slot	0	1	2	3	4	5	6	7	8	9	10	11	12	13	14	15
Speed	AN	AN	AN	AN	AN	AN	AN	AN	AN	AN	AN	AN	AN	AN	AN	AN
Trunk Port	ON	ON	ON	ON	ON	ON	ON	ON	ON	ON	ON	ON	ON	ON	ON	ON
Long Distance	..	..	..	..	..	..	..	..	..	..	..	..	..	..	..	..
VC Link Init	..	..	..	..	..	..	..	..	..	..	..	..	..	..	..	..
Locked L_Port	..	..	..	..	..	..	..	..	..	..	..	..	..	..	..	..
Locked G_Port	..	..	..	..	..	..	..	..	..	..	..	..	..	..	..	..
Disabled E_Port	..	..	..	..	..	..	..	..	..	..	..	..	..	..	..	..
ISL R_RDY Mode	..	..	..	..	..	..	..	..	..	..	..	..	..	..	..	..
RSCN Suppressed	..	..	..	..	..	..	..	..	..	..	..	..	..	..	..	..
Persistent Disable..	..	..	..	..	..	..	..	..	..	..	..	..	..	..	..	..
<b>NPIV capability</b>	<b>ON</b>	<b>ON</b>	<b>ON</b>	<b>ON</b>	<b>ON</b>	<b>ON</b>	<b>ON</b>	<b>ON</b>	<b>ON</b>	<b>ON</b>	<b>ON</b>	<b>ON</b>	<b>ON</b>	<b>ON</b>	<b>ON</b>	<b>ON</b>

- Use the **switchShow** and **portShow** commands to view NPIV information for a given port. If a port is an F\_Port, and you enter the **switchShow** command, then the port WWN of the N\_Port is returned. For an NPIV F\_Port, there are multiple N\_Ports, each with a different port WWN. The **switchShow** command output indicates whether or not a port is an NPIV F\_Port, and identifies the number of virtual N\_Ports behind it. Following is sample output from the **switchShow** command:

```
switch:admin> switchshow
switchName:switch
switchType:66.1
switchState:Online
switchMode:Native
switchRole:Principal
switchDomain:1
switchId:fffc01
switchWwn:10:00:00:05:1e:82:3c:2a
zoning:OFF
switchBeacon:OFF
FC Router:OFF
FC Router BB Fabric ID:128
```

```
Area Port Media Speed State      Proto
=====
  0  0  id  N1  Online      F-Port  1 Nport + 1 NPIV devices.
  1  1  id  N4  No_Light
  2  2  id  N4  Online      F-Port  20:0e:00:05:1e:0a:16:59
  3  3  id  N4  No_Light
  4  4  id  N4  No_Light
  ...
<output truncated>
```

- Use the **portShow** command to view the NPIV attributes and all the N\_Port (physical and virtual) port WWNs that are listed under *portWwn of device(s) connected*. Following is sample output for the **portShow** command:

```
switch:admin> portshow 2
portName: 02
portHealth: HEALTHY

Authentication: None
portDisableReason: None
portCFlags: 0x1
portFlags: 0x24b03 PRESENT ACTIVE F_PORT G_PORT NPIV LOGICAL_ONLINE LOGIN
NOELP LED ACCEPT
portType: 10.0
```

## 13 Viewing NPIV port configuration information

```
portState: 1Online
portPhys: 6In_Sync
portScn: 32F_Port
port generation number: 148
portId: 630200
portIfId: 43020005
portWwn: 20:02:00:05:1e:35:37:40
portWwn of device(s) connected:
c0:50:76:ff:fb:00:16:fc
c0:50:76:ff:fb:00:16:f8
...
<output truncated>
...
c0:50:76:ff:fb:00:16:80
50:05:07:64:01:a0:73:b8
Distance: normal
portSpeed: N2Gbps

Interrupts: 0 Link_failure: 16 Frjt: 0
Unknown: 0 Loss_of_sync: 422 Fbsy: 0
Lli: 294803 Loss_of_sig: 808
Proc_rqrd: 0 Protocol_err: 0
Timed_out: 0 Invalid_word: 0
Rx_flushed: 0 Invalid_crc: 0
Tx_unavail: 0 Delim_err: 0
Free_buffer: 0 Address_err: 1458
Overrun: 0 Lr_in: 15
Suspended: 0 Lr_out: 17
Parity_err: 0 Ols_in: 16
2_parity_err: 0 Ols_out: 15
CMI_bus_err: 0
```

## Viewing virtual PID login information

Use the **portLoginShow** command to display the login information for the virtual PIDs of a port. Following is sample output from the **portLoginShow** command:

```
switch:admin> portloginshow 2
Type PID World Wide Name credit df_sz cos
=====
fe 630240 c0:50:76:ff:fb:00:16:fc 101 2048 c scr=3
fe 63023f c0:50:76:ff:fb:00:16:f8 101 2048 c scr=3
fe 63023e c0:50:76:ff:fb:00:17:ec 101 2048 c scr=3
...
<output truncated>
...
ff 630202 c0:50:76:ff:fb:00:17:70 192 2048 c d_id=FFFFFFC
ff 630201 c0:50:76:ff:fb:00:16:80 192 2048 c d_id=FFFFFFC
```



# Interoperability for Merged SANs

---

## In this chapter

• Interoperability overview . . . . .	297
• Connectivity solutions . . . . .	298
• Domain ID offset modes . . . . .	299
• McDATA Fabric mode configuration restrictions . . . . .	301
• McDATA Open Fabric mode configuration restrictions . . . . .	302
• Interoperability support for logical switches . . . . .	302
• Switch configurations for interoperability . . . . .	303
• Zone management in interoperable fabrics . . . . .	306
• Frame Redirection in interoperable fabrics . . . . .	310
• Traffic Isolation zones in interoperable fabrics . . . . .	310
• Brocade SANtegrity implementation in mixed fabric SANS . . . . .	311
• E_Port authentication between Fabric OS and M-EOS switches . . . . .	311
• FCR SANtegrity. . . . .	321
• FICON implementation in a mixed fabric . . . . .	323
• Fabric OS version change restrictions in an interoperable environment. . . . .	323
• Coordinated Hot Code Load . . . . .	324
• McDATA-aware features. . . . .	325
• McDATA-unaware features . . . . .	326
• Supported hardware in an interoperable environment. . . . .	329
• Supported features in an interoperable environment . . . . .	331
• Unsupported features in an interoperable environment . . . . .	334

## Interoperability overview

A mixed fabric is one with Fabric OS switches and McDATA Enterprise OS switches (M-EOS). The interoperability mode of the switch can be McDATA Fabric mode, McDATA Open Fabric mode, or Brocade Native mode. All switches must have the same interoperability mode set. All fabric mode changes can only be performed when the switch is disabled or offline and any platform management functions must be disabled. Interoperability supports enabling the switch with the following modes:

- **InteropMode 0** for Brocade Native mode, which supports all stand-alone Brocade fabrics, but provides no interoperability support.

- **InteropMode 2** for McDATA Fabric mode, which supports M-EOS switches running in McDATA Fabric mode.
- **InteropMode 3** for McDATA Open Fabric mode, which supports M-EOS switches running in Open Fabric mode.

McDATA Open Fabric mode is intended specifically for adding Fabric OS-based products to M-EOS fabrics that are already using Open Fabric mode. Fabrics containing only Fabric OS switches in Open Fabric mode are not supported.

M-EOS products must operate with the most recent version of M-EOS supported for interoperability. M-EOS v9.7.2 is the minimum version of firmware that is fully qualified to interoperate with Fabric OS v6.2.0 or later. For support of Frame Redirection in McDATA Fabric Mode (interopmode 2), M-EOS products must use v9.8 or later. For support of Frame Redirection in McDATA Open Fabric Mode (interopmode 3), M-EOS products must use v9.9 or later. Only the ES-4400, ES-4700, M6140, and Mi10k switches can have devices directly attached that are having data encrypted or unencrypted.

For a list of the additional switches and backbone platforms that have interoperability built into them, see the section, [“Supported hardware in an interoperable environment”](#) on page 329.

## Connectivity solutions

Although this chapter discusses the mixed fabric interoperability solution using direct E\_Port connectivity, you can use other connectivity solutions. Depending on the requirements for either temporary or permanent fabric interoperability, you can implement the following connectivity solutions:

- **Direct E\_Port connectivity**  
Use direct E\_Port connections when a SAN already has Fabric OS and M-EOS switches and you want to create a single fabric. Direct E\_Port connectivity enables the exchange of fabric parameters, allowing switches to merge into one fabric with one principal switch with each switch having a unique domain ID.
- **Brocade Fibre Channel Routing connectivity**  
Use Fibre Channel Routing for connectivity between host and storage in different fabrics while keeping the fabrics separate or unmerged. The Brocade 7500 and 7500E Extension switches and the Brocade FR4-18i blade can connect to a Fabric OS switch for routing between fabrics. The Brocade 5100, 5300, 7800, VA-40FC, DCX, DCX-4S, and Brocade Encryption Switch can also be used for FC routing with the Integrated Routing license. For more information, see [Chapter 21, “Using the FC-FC Routing Service”](#).
- **Access Gateway connectivity**  
Use Access Gateway (AG) when you have switches from different vendors. AG uses N\_Port Virtualization (NPIV) functionality in Brocade embedded switches in AG mode. NPIV enables multiple hosts to connect through one port to any fabric switch that supports NPIV. AG connectivity allows the mapping of multiple virtual nodes to a single physical node or port. For more information, see the *Access Gateway Administrator's Guide*.

[Figure 50](#) shows fabric interoperability with switch-to-switch connectivity between different hardware, for example, Mi10K, M6140, M6064, and the DCX Backbone platform. This connectivity is established using direct E\_Port connections using ISLs.

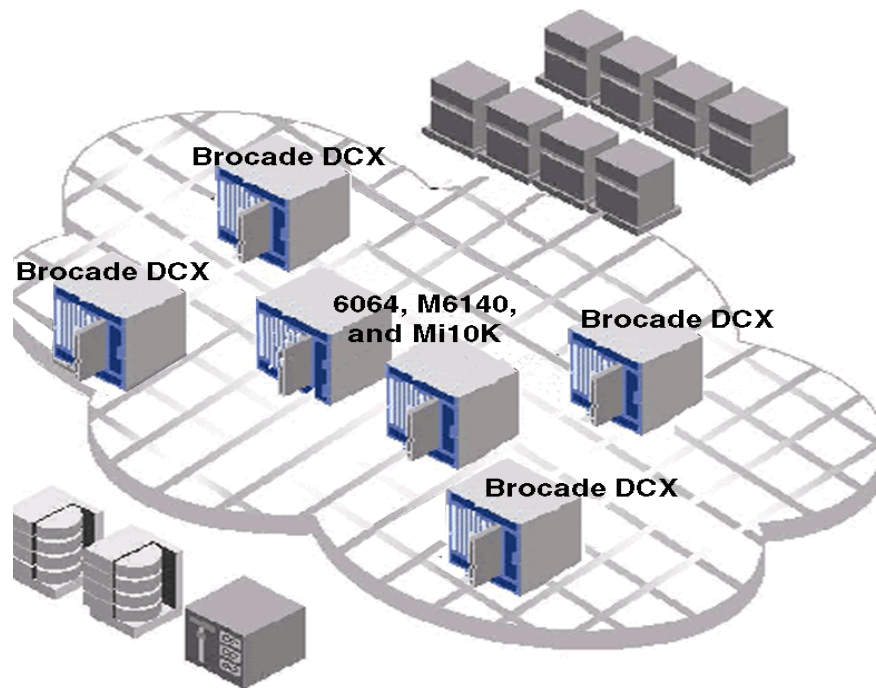

FIGURE 50 Typical direct E\_Port configuration

## Domain ID offset modes

The domain ID offset in interopmode 3 (IM3) allows an M-EOS switch to operate in a fabric that contains domain IDs other than 1-31. In interopmode 2 (IM2) the domain ID offset can only be in the 1-31 range. In IM3, the domain ID offset only changes the range of domain IDs used, the restriction of 31 switches in a fabric remains. You can select a domain ID offset, for example 0x00, 0x20, 0x40, 0x60, 0x80, 0xa0, or 0xc0, to allow Fabric OS switches in IM2 or IM3 to work in all of the domain ID ranges currently supported by Fabric OS. By default, Fabric OS switches operate in the legacy domain ID mode offset 96 (0x60).

When you change the domain ID offset, the Fabric OS switches must be offline and in the default domain ID mode or in a domain ID offset mode with the same domain ID offset. This can be an interopmode or an offset mode range. When switches attempt to join with a non-matching domain ID offset, they will segment. A Fabric OS switch that is online and is joined to another fabric that contains a switch with an out-of-range domain ID will also segment.

Using the **interopMode --enable -mcdata/openmcdata** command, configured domain ID offset values do not change when you switch between IM2 and IM3, but the configured values behave differently. In an IM2 fabric in legacy offset mode, the device offset is 0x60 but the domain controller offset is 0x20. For all other domain ID offset values, the device offset is the same as the domain controller offset. In IM3 the device offset is always the same as the domain controller offset. The offset is used to define the minimum and maximum of the domain ID range. Refer to [Table 54](#) and [Table 55](#) on page 300 for the internal representation of domain ID offset values in IM2 and IM3 respectively.

**TABLE 54** Internal representations of ID domain offsets in IM2.

Domain Offset	Domain ID	PID Area affected
0x00	0x01	01XXYY
0x20	0x21	21XXYY
0x40	0x41	41XXYY
0x60	0x01	61XXYY
0x80	0x81	81XXYY
0xA0	0xA1	A1XXYY
0xC0	0xC1	C1XXYY

**TABLE 55** Internal representations of ID domain offsets in IM3.

Domain Offset	Domain ID	PID Area affected
0x00	0x01	01XXYY
0x20	0x21	21XXYY
0x40	0x41	41XXYY
0x60	0x61	61XXYY
0x80	0x81	81XXYY
0xA0	0xA1	A1XXYY
0xC0	0xC1	C1XXYY
239 Domain Mode	0x01	01XXYY

For instructions to convert decimal numbers to hexadecimal, refer to [Appendix E, “Hexadecimal”](#).

When changing from IM3 with a 239 Domain ID configuration to IM2, you must first reconfigure the domain ID offset to a value supported in IM2 or IM3 or the operation fails.

Following are the configurable domain ID offset modes:

- **Domain ID default mode** (McDATA Legacy domain ID mode) — In this mode, a default offset of 0x60 (96) is used. The default mode is used when you enable IM2 or IM3 without specifying a Domain ID offset.

In IM 2: You only need to enter a decimal number in the 1-31 range when configuring a Domain ID in default mode.

In IM 3: The Domain ID is always in the range of 97-127, or 1-31 plus the default Domain ID Offset of 0x60 (96). For example, the Domain ID of 5 would be configured as 101 (101 - 96= 5).

- **Domain ID offset mode** — In this mode, you can set the Domain ID Offset to any one of the following values: 0x00, 0x20, 0x40, 0x80, 0xA0, or 0xC0. Supported Domain ID ranges are: 1-31, 33-63, 65-95, 129-159, 161-191, 193-223.  
In IM 2: Once the domain ID offset is set, you only need to enter a decimal number in the 1-31 range when configuring a Domain ID in IM2. There is no need to derive the Domain ID by subtracting the offset.  
In IM 3: The Domain ID is always in the range of 1-31 plus the configured Domain ID Offset. For example, if the configured Domain ID Offset is 0x80 (128), the Domain ID of 5 must be configured as 133 (133 - 128 = 5).
- **239 Domain\_ID mode** — Supports the full range of domain ID s and is available for interopmode 3 only. This mode is only supported on the Mi10k switch and is not supported on any of the EOSc switches. To enable 239 Domain ID Mode, specify a domain ID offset of 0xFF; then choose any Domain ID in the 1-239 range.

## Configuring the Domain\_ID offset

Only the offset is configured using the **interopMode** command. The actual domain id is configured using the **configure** command. The offset itself is always entered in hexadecimal and displayed in hexadecimal in switch show. For instructions to convert decimal numbers to hexadecimal, refer to [Appendix E, “Hexadecimal”](#).

1. Connect to the switch and log in using an account assigned to the admin role.
2. Enter the **interopmode --enable** command for your interop mode.
3. Choose the domain ID offset for your fabric.

---

### ATTENTION

The switch automatically sets itself online once the domain ID offset has been changed.

---

4. Once the domain ID offset is set, go to the configure command to set the domain ID, if applicable. For more information on configuring the domain ID refer to [Chapter 2, “Performing Basic Configuration Tasks”](#).

## McDATA Fabric mode configuration restrictions

The following restrictions apply to McDATA Fabric mode (interopmode 2) configurations:

- A maximum of 2048 devices can be logged in to the fabric.
- A maximum of 31 switches or domain IDs can be defined.
- Domain IDs must be in the decimal range of 1 to 31 or domain ID offset value range, on Fabric OS switches for successful connections to M-EOS switches. The firmware automatically assigns a valid domain ID.

---

### NOTE

If insistent domain ID (IDID) is not enabled and a switch attempts to join the fabric with a duplicate DID, the principal switch will assign the incoming switch a different domain ID. If the principal switch cannot assign a different domain ID to the incoming switch, it will segment from the fabric.

---

- The DCC policy or port based security is not supported in McDATA Fabric mode.

- Platform management functions must be deactivated before connecting a Fabric OS switch to an M-EOS switch because M-EOS switches do not understand Brocade proprietary frames used to exchange platform information.
- In the default domain ID mode, the domain IDs of all switches in the fabric must fall within the decimal range of 1-31 or 97-127 range.
- Older McDATA switches that use domain IDs in the decimal range 97-127 cannot be in the same fabric as switches using the domain ID offset mode. These older switches are allowed only with the default domain ID offset mode.

---

**NOTE**

To convert decimal numbers to hexadecimal format, refer to [Appendix E, "Hexadecimal"](#)

---

## McDATA Open Fabric mode configuration restrictions

The following restrictions apply to McDATA Open fabric mode (interopmode 3) configurations:

- A maximum of 2048 devices can be logged in to the fabric.
- A maximum of 31 switches domain IDs can be defined.
- Domain IDs must be in the 97-127 value range on Fabric OS switches for successful connections to M-EOS switches. M-EOS must be set with the default domain offset 96. M-EOS switches see the domains as 1-31; devices see the domains as 97-127.
- *Domain,index* zoning, or default zoning, or Safezoning, are not supported.
- McDATA SANtegrity feature is not supported for FICON.
- Zone activations and zoning management are not supported except when using DFCM 10.3 or later. Using DFCM 10.3 or later a zone can be activated and deactivated as long as there is an EOSc switch in the fabric.
- The Defined Database is not supported in McDATA Open Fabric mode because zone sets cannot be managed from Fabric OS switches in this mode.
- Brocade proprietary features are not supported.
- Platform management functions must be deactivated before connecting a Fabric OS switch to an M-EOS switch because M-EOS switches do not understand Brocade proprietary frames used to exchange platform information.
- The 239 Domain\_ID mode is supported only on the Mi10K switch. None of the EOSc switches support this mode.

## Interoperability support for logical switches

Interoperability for logical switches is supported on the Brocade 5100, 5300, and VA-40FC switches, and the Brocade DCX and DCX-4S platforms. You can configure logical switches individually to operate in any of the interoperable modes. This means that McDATA Fabric mode, McDATA Open Fabric mode, and Brocade Native mode are supported in the same chassis. Although there is always at least one logical switch instance per chassis, multiple logical switch instances can exist in a chassis.

In a Virtual Fabric, the logical switch used to communicate among different logical switches is called the base switch and it must be in Brocade Native mode. If you set a logical switch to interopmode 2 or interopmode 3, it cannot use the logical links between two logical switches if they were connected using extended ISLs that were formed as part of the base fabric.

All logical switch-to-logical switch or Layer 2 switch connections must be through ISLs or dedicated ISLs for switches in interopmode 2 or interopmode 3. You can change the interopmode of a logical switch after it is created; it takes effect immediately without having to reboot the system.

All switches participating in a standard or logical fabric must be set to the same interopmode in order to merge the fabric. For more information on Virtual Fabrics, see [“Managing Virtual Fabrics”](#) on page 209.

---

**NOTE**

A dedicated ISL is a connection between two logical switches or other Layer 2 switches using E\_Port connections.

---

## Switch configurations for interoperability

You can enter the **interopMode** command with the appropriate parameter to change the mode of the switch to McDATA Fabric, McDATA Open Fabric, and Brocade Native modes. In v6.0.0 or later, when McDATA Fabric interoperability mode is turned on, the OUI portion of the switch WWN is no longer replaced with a McDATA OUI. The Brocade OUI is used. However, upgrading from Fabric OS 5.2.1\_NI to Fabric OS v6.0.0 or later will be non-disruptive, preserving the McDATA OUI and the given interopMode. Unless the switch is taken offline, and the interopMode is changed, or the OUI is changed with the **configure** command, the McDATA OUI is preserved.

The following restrictions apply when changing from Brocade Native (IM0) to McDATA Fabric (IM2) or McDATA Open Fabric Mode (IM3):

- Existing zone configurations, defined and effective, are erased. The switch assumes the zone configuration from the fabric it joins, unless you create a new configuration.
- If you do not specify a Domain ID offset, the Domain ID default mode is used (offset 0x60).

The following restrictions apply when changing from McDATA Fabric (IM2) or McDATA Open Fabric Mode (IM3) to Brocade Native Mode (IM0):

- Existing zone configurations, defined and effective, are erased. The switch assumes the zone configuration from the fabric it joins, unless you create a new configuration.

---

**ATTENTION**

When interoperability mode is disabled, all configuration parameters return to their default states and can be modified using the **configure** command.

---

## Enabling McDATA Open Fabric mode

When configuring McDATA Open Fabric mode, avoid domain ID conflicts before fabric reconfiguration. When configuring multiple switches, you should wait for a fabric reconfiguration after adding or removing each switch. Every switch in the fabric must have a unique domain ID.

## 14 Switch configurations for interoperability

1. Verify that you have implemented all the Brocade prerequisites necessary to enable **interopMode 3** on the fabric (see [“McDATA Open Fabric mode configuration restrictions”](#) on page 302.)
2. Connect to the switch and log in using an account assigned to the admin role.
3. Enter the **switchDisable** command.  

```
switch:admin> switchdisable
```
4. Enter the **configure** command to set the domain ID to a number in the range from 97 to 127; otherwise, the **interopMode** command defaults to 97. (For detailed instructions, see [Chapter 2, “Performing Basic Configuration Tasks”](#).)  

```
switch:admin> configure
Configure...
Fabric Parameters (yes, y, no, n): [no] y
Domain (1...239): [1] 97
```
5. Enter the **interopMode 3** command to enable interoperability. This command resets a number of parameters and enables McDATA Open Fabric mode.  

```
switch:admin> interopmode 3
The switch effective and defined configuration
will be lost if interop Mode is changed.

Interop Mode or Domain Offset Will Be Changed
and switch will be Enabled

Do you want to continue? (yes, y, no, n): [no] y
```
6. Repeat [step 2](#) through [step 5](#) on each Fabric OS switch in the fabric.
7. After enabling McDATA Open Fabric mode on all switches, physically connect the legacy M-EOS switches to the Fabric OS fabric, one at a time.

### Enabling McDATA Fabric mode

When McDATA Fabric mode is enabled, the OUI portion of the switch WWN is no longer replaced with a McDATA OUI. All existing zoning configurations are cleared.

1. Verify that you have implemented all the Brocade prerequisites necessary to enable **interopMode 2** on the fabric (see [“McDATA Fabric mode configuration restrictions”](#) on page 301.)
2. Connect to the switch and log in using an account assigned to the admin role.
3. Enter the **switchDisable** command.  

```
switch:admin> switchdisable
```
4. Enter the **configure** command to set the domain ID to a number in the range from 1-31. (For detailed instructions, see [Chapter 2, “Performing Basic Configuration Tasks”](#).)  

```
switch:admin> configure
Configure...
Fabric Parameters (yes, y, no, n): [no] y
Domain (1...31): [1] 5
```
5. Enter the **interopMode 2** command to enable interoperability. This command resets a number of parameters and enables fabric mode.  

```
B5000_205:admin> interopmode 2
```



```
The switch effective and defined configuration
will be lost if interop Mode is changed.
```

```
Interop Mode or Domain Offset Will Be Changed
and switch will be Enabled
```

```
Do you want to continue? (yes, y, no, n): [no] y
```

6. Repeat [step 2](#) through [step 5](#) on each Fabric OS switch in the fabric. For more information on the switch, refer to the switch documentation.
7. After enabling McDATA Fabric mode on all switches, physically connect the legacy M-EOS switches to the Fabric OS fabric, one at a time.

## Enabling Brocade Native mode

You can configure logical switches in Brocade Native mode. When you change the mode from McDATA Fabric or McDATA Open Fabric mode to Brocade Native mode, existing configurations are erased and the switch must assume the zone configuration from the fabric it joins or a new configuration must be configured. When you change the switch to Brocade Native mode, all configuration parameters return to their default states and can be modified using the **configure** command. The existing preferred configuration must be changed to a value within the user domain ID range specified for the mode before changing to Brocade Native mode is allowed. If the preferred domain ID is not in this range, the mode conversion changes the domain ID to 1.

---

### NOTE

McDATA switches cannot communicate with switches in Brocade Native mode.

---

1. Connect to the switch and log in using an account assigned to the admin role.
2. Enter the **switchDisable** command to disable the switch.
 

```
switch:admin> switchdisable
```
3. Enter the **interopMode 0** command to disable interoperability.
 

This command resets a number of parameters and disables McDATA Open Fabric mode or the McDATA Fabric mode.

```
switch:admin> interopmode 0
The switch effective and defined configuration
will be lost if interop Mode is changed.
```

```
Interop Mode or Domain Offset Will Be Changed
and switch will be Enabled
```

```
Do you want to continue? (yes, y, no, n): [no] y
```

4. After removing each switch, wait for a fabric reconfiguration.
5. Repeat this procedure on all Fabric OS switches in the fabric.

## Zone management in interoperable fabrics

McDATA Fabric and McDATA Open Fabric modes support zone activation using an M-series management tool such as Data Center Fabric Manager (DCFM) or Web Tools. The command line interface (CLI) can also be used as a zone management tool for both IM2 and IM3. CLI commands are very limited in IM3. CLI commands for IM3 are available for Frame Redirect support. All management tools can be launched at one time. Although, nothing prevents you from attempting to make changes to the zone configuration at the same time, DCFM is the preferred management tool.

The Defined Database is where special zones, such as, Frame Redirection and Traffic Isolation zones, reside on Fabric OS switches. When joining switches in a mixed fabric, the Defined Database does not merge with the M-series switch zoning databases. McDATA Fabric and McDATA Open Fabric modes support zone activation, which allows fabric-wide and stand-alone zone configurations, for Traffic Isolation and Frame Redirection only. You can create new zones, modify existing zones, and then save these configurations to the Defined Database on the local Fabric OS switch. This allows the distribution of the Defined Database to all Fabric OS switches in McDATA Fabric mode in the case where the Fabric OS switches are used to control zone management for TI and FR zones. When joining switches in a mixed fabric, the Defined Database does not merge with M-series switches.

### Zoning restrictions

Before creating or configuring a zone, note the following zoning characteristics and requirements for McDATA Fabric and McDATA Open Fabric modes:

- There are four zoning limits that must be met:
  - Maximum Number of Zones – 2047 (+1 for the default zone)
  - Maximum Number of Members per Zone – 4096
  - Maximum Number of Unique Zone Members per Zone Set – 4096
  - Maximum Zone Set Definition Size – 2048 Kb
- IM2 and IM3 support LSAN zones to export devices across an FCR backbone. The FCR backbone cannot be in IM2 or IM3, it must be in IM0.
- Only zoning by port WWN is allowed in IM3 only; you must use the port WWN of the device, such as 10:00:00:00:c9:28:c7:c6.
- Zone members specified by node WWN are ignored.
- Zone database is managed on the DCFM management server.
- Fabric OS switches connected to M-EOS switches receive the effective configuration when a zone merge occurs. (M-EOS only has an effective zone configuration and discards the defined zone configuration when it sends merge information to the Fabric OS switch.) However, a zone update sends the defined and effective configuration to all switches in the fabric.
- When no zoning configuration is in effect, and without default zoning enabled on an M-EOS switch, by default, all ports are isolated and traffic is not permitted. This is unlike Brocade behavior with Brocade Native mode enabled (and all data traffic is enabled). If the default zone is disabled and there is no active configuration, then no device can communicate with any other device in the fabric if zoning is disabled on a Fabric OS switch.
- Defining zones in the effective configuration or the Defined Database is allowed in IM2 only.
- Legacy McDATA switches do not support the Defined Database or merge propagation.

- Zoning using *domain,port* notation is allowed. Zone configurations that use either physical port numbers or port IDs are supported.
- Zoning using *domain,index* notation is allowed only in McDATA Fabric mode (IM2) only, not Open fabric mode (IM3).

## Zone name restrictions

The name value must contain the ASCII characters that actually specify the name, not including any required fill bytes. Names must follow these rules:

- Length must be between 1 and 64 characters.
- All characters must be 7-bit ASCII.
- The first character must be a letter, which can be either uppercase (A-Z) or lowercase (a-z).
- Any character other than the first character must be lowercase (a-z), uppercase (A-Z), a single-digit number (0-9), or underscore ( \_ ).

McDATA Fabric mode allows the characters dash ( - ), caret ( ^ ) and dollar sign ( \$ ) in zone names.

## Zoning modes

Activating zones creates zone configurations on legacy McDATA switches. McDATA default zone and safe zone modes replace the Brocade default zoning mode. You can set McDATA default zone mode or McDATA safe zone mode, but not both. Setting the default zone enables any device in the default zone to see any other device in the default zone. If the default zone is disabled and no zones are active, then devices connected to the switch are unable to communicate.

### *Default zoning mode*

The default zoning mode controls device access if zoning is not implemented or if there is no effective zone configuration. It adds devices not explicitly zoned to a default “catch-all” zone in M-EOS fabrics. When a device is added to a configured zone, it is automatically removed from the default zone. Default zoning is fabric-wide and is exchanged during E\_Port initialization between adjacent switches. After the E\_Port initialization, if zoning is changed, the update is propagated throughout the fabric through a standard zone update. There is a limit of 64 devices in the default zone. Default zoning and safe zoning cannot be active at the same time. Default zoning and safe zoning are not available in IM3.

---

#### **ATTENTION**

If you have fabric comprising of Fabric OS switches in IM2 mode, then the device limit in the default zone is not software enforced.

---

Default zoning should be off, but there is no check that it is turned off. The configuration is reset. If you have a defined or effective configuration and default zoning is on, when you disable the switch and change to McDATA Open Fabric mode, you are informed that all configurations will be lost. Responding “yes” puts the system in McDATA Open Fabric mode with default zoning and safe zoning turned off.

This mode is not supported in interopmode 3. For details, see “Activating Default Zones” in [Chapter 11, “Administering Advanced Zoning”](#).

## *Safe zoning mode*

The safe zoning mode is a fabric-wide parameter that ensures that the resulting zone set of two merged fabrics is consistent with the pre-merged zone sets. When you enable the safe zoning mode, the default zoning mode must be disabled and the zoning configuration of neighboring switches must match completely before the zoning can merge.

---

### ATTENTION

Safe zoning mode is only available in fabrics with their interoperable mode set to 2.

With safe zoning enabled, the effective configurations must match exactly. Also, it does not allow the default zone to be enabled.

---

To allow a Fabric OS switch into an M-EOS native fabric, safe zoning mode must be disabled. This allows the Fabric OS switch to join the fabric although the zone sets do not match. After the fabric merge and zone merge are completed, safe zoning may be re-enabled.

## Setting the safe zone mode on a stand-alone switch

1. Connect to the switch and log in using an account assigned to the admin role.
2. Enter the **switchDisable** command.
3. Enter the **interopMode** command.

```
switch:admin> interopmode --enable -safezone
safezoning McDATA mode has been enabled
```

## Setting the safe zone mode fabric-wide

1. Connect to the switch and log in using an account assigned to the admin role.
2. Enter the **cfgMcdtMode** command.

```
switch:admin> cfgmcdtmode --enable safezoning
safezoning McDATA mode has been enabled ...
```

---

### NOTE

The **interopMode** and **cfgMcdtMode** commands perform the same basic functions. However, the **interopMode** command only affects the local configuration and the command must be issued on each switch in the fabric. The **cfgMcdtMode** affects the entire fabric.

---

## Disabling safe zone mode

1. Connect to the switch and log in using an account assigned to the admin role.
2. Enter the **cfgMcdtMode** command.

```
switch:admin> cfgmcdtmode --disable safezoning
safezoning McDATA mode has been disabled ...
```

## Effective zone configuration

An effective zone configuration is a subset of the defined zone configuration, containing only the zone configuration objects that are currently enabled; only one configuration can be effective at a time, but multiple configurations can be defined in the database. The effective zone set or zone configuration must correctly propagate to the other switches in the fabric.

When uploading and downloading configuration files, you must be sure that the file being moved contains the correct information. After a configuration is committed, any inaccurate parameters must be manually corrected.

In McDATA Fabric mode, you can set the effective zone configuration to the Defined Database. If the Defined Database contains a configuration with the same name, it is replaced. Any non-duplicate zone sets or zones remain unchanged. Before moving the effective zone configuration to the Defined Database, you should view the zoning configuration.

In Fabric OS v6.4.0, the **cfgDownload** and **cfgUpload** commands support the zone database if the fabric mode does not change. The effective configuration must be copied to the Defined Database. When the Defined Database is updated, the changes are pushed to all switches in the fabric as a **cfgSave** operation. Uploading and downloading a configuration file from Fabric OS v6.2.0 to Fabric OS v6.4.0 is allowed, however downloading a configuration file from Fabric OS v6.4.0 to Fabric OS v6.2.0 is not allowed.

The configuration file download triggers the fabric mode change, which supports the initial configuration of new switches. This prevents fabric mode changes from being rejected.

## Saving the effective zone configuration to the Defined Database

The Defined Database is not synchronized between Fabric OS switches in McDATA Fabric mode. When you create a zone configuration on one switch, the new configuration is not synchronized to the Defined Database. You must save the configuration to synchronize it to the Defined Database.

1. Connect to the switch and log in using an account assigned to the admin role.
2. Enter the **cfgSaveActiveToDefined** command.

```
switch:admin> cfgsaveactivetodefined
You are about to save the Defined zoning configuration. This
action will save the effective configuration to the defined
configuration.
Do you want the Effective zoning to become the Defined
zoning? (yes, y, no, n): [no] yes
Attempting to save new config to the defined config...
2sw0 Updating flash ...
...
[output truncated]
...
Attempting to save config to the defined config...
2sw0 Updating flash ...
Updating flash ...
```

## Frame Redirection in interoperable fabrics

Frame Redirection provides a means to redirect traffic flow between a host and a target to virtualization and encryption applications so that those applications can perform without having to reconfigure the host and target. Use this feature if the hosts and targets are not directly attached to M-EOS switches.

---

### NOTE

For support of Frame Redirection in McDATA Fabric Mode (interopmode 2), M-series products must use M-EOS v9.8 or later. For support of Frame Redirection in McDATA Open Fabric Mode (interopmode 3), M-series products must use M-EOS v9.9 or later. Only the ES-4400, ES-4700, M6140, and Mi10k switches can have devices directly attached that have data encrypted or unencrypted.

---

The Defined Zone Database in McDATA Open Fabric mode supports the special Frame Redirect zones. Frame Redirection supports the following:

- Allows you to create Frame Redirection zones and send redirection zone updates to switches running M-EOS in McDATA Open Fabric mode (interopmode 3) and McDATA Fabric mode (Interopmode 2).
  - Allows redirection of data traffic for hosts and targets attached to switches running M-EOS.
  - Allows you to create FR zones and distribute the defined database when in McDATA Open Fabric mode (IM3) only.
  - Allows you to use the Host Offline Re-Key feature for switches running M-EOS.
- 

### NOTE

There are no limitations on fabric configurations other than the normal McDATA Open Fabric mode fabric limitations. Hosts and targets can be both attached to McDATA switches or spread among switches running Fabric OS and switches running M-EOS.

---

For information on frame redirect zones, see in [Chapter 4, "Routing Traffic"](#).

## Traffic Isolation zones in interoperable fabrics

The Traffic Isolation feature allows you to control the flow of interswitch traffic by creating a dedicated path for traffic flowing from a specific set of source ports through Fabric OS switches using zones. Traffic isolation (TI) is supported in McDATA Fabric mode on Fabric OS switches only; McDATA Fabric mode is the only mode that supports the Defined Database, which is distributed and synchronized with all Fabric OS switches in a fabric. TI zones within edge fabrics are used to route traffic between real devices and proxy devices to a particular EX\_Port.

Use the M-EOS Preferred Path method to steer application traffic down a particular path when traversing M-EOS switches. In the case where a Preferred Path goes away, only the ports assigned to that path are re-routed to other paths. When the Preferred Path is re-established, the ports assigned to that path are re-routed back.

Use the Prohibit Dynamic Connectivity Mask (PDCM) method for specific forced network control. You must perform this configuration at the director or backbone platform level.

For detailed information on creating TI zones, see [Chapter 18, "Optimizing Fabric Behavior"](#).

## Brocade SANtegrity implementation in mixed fabric SANS

SANtegrity is required only in legacy M-EOS fabrics running DCFM management software. In mixed fabrics, FICON requires using Fabric Binding to define switches, and to verify the inter-switch link (ISL) restrictions.

Because Fabric Binding authorizes joining switches based on both WWN and domain ID, Fabric Binding requires that domain IDs are statically allocated, and thus requires Insistent Domain IDs in conjunction with Fabric Binding.

Each device in the mixed fabric requires authentication and must prove its identity through the protocols FC-SP, iSCSI, FC-GS, FC-SB, and iFCP. The standards-based authentication is used by Brocade SANtegrity for both FC and IP block-based protocols, as well as in-band management.

### Fabric OS Layer 2 Fabric Binding

The Fabric OS SANtegrity binding feature locks the fabric into its intended configuration and ensures protection against WWN spoofing for E\_Ports and N\_Ports. Switches must exchange and validate their Fabric Binding Membership list when bringing up an ISL.

Enabling Fabric Binding using DCFM automatically enables Insistent Domain ID on all Fabric OS and M-EOS switches in the fabric. Disabling Fabric Binding does not turn off Insistent Domain ID. The firmware supports a Fabric OS switch sending the Exchange Fabric Binding Membership Data (EFMD) command to neighbor switches during link initialization whenever it has an active security policy, such as the Switch Connection Control policy (SCC) Access Control List (ACL). McDATA Fabric mode supports the EFMD, which supports FICON cascading security requirements.

When you enable Fabric Binding, only the switches that are currently in the fabric are included in the binding list that is sent out. A Fabric Binding check is performed each time a link is initialized to ensure that the switches can connect. If this check fails on either switch, the link segments.

You must disable Fabric Binding to downgrade to a Fabric OS version that does not support SANtegrity; otherwise, the links will segment when you attempt to initialize the switch. In this case, you should disable, and then re-enable or add a new ISL.

The DCFM software synchronizes the Fabric OS and M-EOS security policies and enables Fabric Binding. This ensures that the security policies of both Fabric OS and M-EOS switches in a fabric are properly configured so that Fabric Binding works properly.

Configurations through other management interfaces are not recommended. In cases where existing configured SCC policies require consistency fabric-wide, use the **fddCfg** command, which works in both McDATA Open Fabric mode and McDATA Fabric mode.

Refer to the [Chapter 7, “Configuring Security Policies”](#) for more information on setting the fabric-wide consistency for the SCC policy.

## E\_Port authentication between Fabric OS and M-EOS switches

E\_Port Authentication allows switches to authenticate connections to other switches. You can use E\_Port Authentication in both McDATA Open Fabric mode and McDATA Fabric mode. Using this feature requires that the proper license keys are activated on both the Fabric OS and the M-EOS switches. For information on setting the license keys, see [Chapter 16, “Administering Licensing”](#). Switch secrets must be set correctly; otherwise, authentication will fail.

Because M-EOS only supports the DH-CHAP authentication, not all Fabric OS authentication configurations work when connected to an M-EOS switch. With DH-CHAP authentication, you must configure the shared secrets on both switches. For details on procedures to configure shared secrets, see the [Chapter 7, “Configuring Security Policies”](#).

[Table 56](#) describes the Fabric OS authentication types.

**TABLE 56 Fabric OS switch authentication types**

Fabric OS authentication types	M-EOS support	M-EOS switch explanation
FCAP, DH-CHAP	Yes	M-EOS switch selects the supported DH-CHAP protocol.
FCAP	No	M-EOS switch does not support FCAP protocol.
DH-CHAP	Yes	DH-CHAP supported.

[Table 57](#) describes the Fabric OS mode descriptions.

**TABLE 57 Fabric OS mode descriptions**

Fabric OS authentication modes	M-EOS support	M-EOS switch explanation
Passive	Yes	The Fabric OS switch participates in the authentication policy initiated by the M-EOS switch, but does not initiate authentication.
Active	Yes	During switch initialization, authentication is initiated on all E_Ports, but the port is not disabled if the connecting M-EOS switch does not support authentication, for example, if the authentication feature key is not installed on the M-EOS switch.
On	Yes	Strict authentication is enforced on all E_Ports. The ISL goes down (port disable) if the connecting M-EOS switch does not support authentication, for example, if the authentication feature key is not installed on the M-EOS switch.
Off	Yes	Turns off the authentication and the switch rejects any authentication requests issued from the M-EOS switch.

**NOTE**

An M-EOS switch can connect to a Fabric OS switch in any of the switch authentication modes.

[Table 58](#) describes the DH group types.

**TABLE 58 DH group types**

Fabric OS DH group type	M-EOS support	M-EOS switch explanation
0, 1, 2, 3, 4	Yes	M-EOS selects DH Null option (only supports 0).
0 (DH Null option)	Yes	0 (DH Null option) supported.
1 (1024-bit key)	No	Not supported by M-EOS.
2 (1280-bit key)	No	Not supported by M-EOS.
3 (1536-bit key)	No	Not supported by M-EOS.
4 (2048-bit key)	No	Not supported by M-EOS.



Table 59 describes the device authentication mode.

**TABLE 59** Device authentication mode

Fabric OS authentication mode	M-EOS support	M-EOS switch explanation
Off	N/A	Not used for E_Port authentication.
Passive	N/A	Not used for E_Port authentication.

## Switch authentication policy

There are differences in the Switch Authentication policies between the Fabric OS switch and the M-EOS switch. The Fabric OS switches have four different settings, which are Passive, Active, On, and Off. M-EOS switches only have On and Off. These differences do not prevent authentication from working, but do have an effect on how authentication works between the switches.

### *Switch authentication policy when the switch secrets are correct*

This section assumes that the M-EOS switch has the appropriate authentication feature keys enabled.

Table 60 shows all the permutations of Switch Authentication policies and whether the switches will connect. The table information assumes that all switch secrets are set correctly. The two places where Yes\* appears in the table, are cases where the M-EOS switch authentication is Off.

The Fabric OS switch mode Passive is different from the M-EOS switch mode Off in that Fabric OS switches perform authentication in Passive mode. This is why a Yes! in Table 60 indicates two-way authentication.

**TABLE 60** Switch authentication policy when all secrets are correct

Fabric OS	Passive	Active	On	Off
M-EOS				
On	Yes! Connected with two-way authentication; both sides of the connection perform Authentication (Fabric builds normally).	Yes! Connected with two-way authentication; both sides of the connection perform Authentication (Fabric builds normally).	Yes! Connected with two-way authentication; both sides of the connection perform Authentication (Fabric builds normally).	No E_Port does not connect (Authentication Rejected). When the Fabric OS switch generates the reject, it will disable the Fabric OS port. When the M-EOS switch generates the reject, it will go to an invalid attachment state.
Off	Yes Connected without any authentication (Fabric builds normally).	Yes* Connected with one-way authentication; only one of connected switches performs Authentication (Fabric builds normally).	Yes* Connected with one-way authentication; only one of connected switches performs Authentication (Fabric builds normally).	Yes Connected without any authentication (Fabric builds normally).

***Authentication policy when the secrets are not correct***

Table 61 and Table 62 show the connection status for the cases where the authentication secrets are incorrect. Table 61 shows the E\_Port connection status when the Fabric OS switch does not have the correct secret for the M-EOS switch.

**TABLE 61 Switch authentication policy - Fabric OS switch with incorrect peer secret for M-EOS switch**

Fabric OS	Passive	Active	On	Off
M-EOS				
On	No E_Port does not connect (Authentication Rejected). When the Fabric OS switch generates the reject, it will disable the Fabric OS port. When the M-EOS switch generates the reject, it will go to an invalid attachment state.	No E_Port does not connect (Authentication Rejected). When the Fabric OS switch generates the reject, it will disable the Fabric OS port. When the M-EOS switch generates the reject, it will go to an invalid attachment state.	No E_Port does not connect (Authentication Rejected). When the Fabric OS switch generates the reject, it will disable the Fabric OS port. When the M-EOS switch generates the reject, it will go to an invalid attachment state.	No E_Port does not connect (Authentication Rejected). When the Fabric OS switch generates the reject, it will disable the Fabric OS port. When the M-EOS switch generates the reject, it will go to an invalid attachment state.
Off	Yes Connected without any authentication (Fabric builds normally).	No E_Port does not connect (Authentication Rejected). When the Fabric OS switch generates the reject, it will disable the Fabric OS port. When the M-EOS switch generates the reject, it will go to an invalid attachment state.	No E_Port does not connect (Authentication Rejected). When the Fabric OS switch generates the reject, it will disable the Fabric OS port. When the M-EOS switch generates the reject, it will go to an invalid attachment state.	Yes Connected without any authentication (Fabric builds normally).

In this case, when the Fabric OS switch is in Active or On mode, and the M-EOS switch is Off, the E\_Port does not connect because the Fabric OS switch rejects the authentication based on the secret mismatch. However, Table 62 shows the opposite case where the M-EOS switch has the incorrect peer secret for the Fabric OS switch. In the same condition, when the Fabric OS switch is in Active or On mode, and the M-EOS is Off, the E\_Port does connect (one-way authentication) because the M-EOS will not perform authentication. The fact that the secret is wrong is insignificant.

**TABLE 62** Switch authentication policy-M-EOS switch with the incorrect peer secret for Fabric OS switch

Fabric OS	Passive	Active	On	Off
M-EOS				
On	No E_Port does not connect (Authentication Rejected). When the Fabric OS switch generates the reject, it disables the Fabric OS port. When the M-EOS switch generates the reject, it goes to an invalid attachment state.	No E_Port does not connect (Authentication Rejected). When the Fabric OS switch generates the reject, it disables the Fabric OS port. When the M-EOS switch generates the reject, it goes to an invalid attachment state.	No E_Port does not connect (Authentication Rejected). When the Fabric OS switch generates the reject, it disables the Fabric OS port. When the M-EOS switch generates the reject, it goes to an invalid attachment state.	No E_Port does not connect (Authentication Rejected). When the Fabric OS switch generates the reject, it disables the Fabric OS port. When the M-EOS switch generates the reject, it goes to an invalid attachment state.
Off	Yes Connected without any authentication (Fabric builds normally).	Yes* Connected with one-way authentication; only one of connected switches performs Authentication (Fabric builds normally).	Yes* Connected with one-way authentication; only one of connected switches performs Authentication (Fabric builds normally).	Yes Connected without any authentication (Fabric builds normally).

If the same secret is used on both the Fabric OS switch and the M-EOS switch, it will be treated as an incorrect secret.

## Dumb switch authentication

A dumb switch refers to a switch that does not know anything about authentication. An M-EOS switch becomes a dumb switch when it does not have the authentication feature keys enabled (specifically the SANtegrity 1 and SANtegrity 2 feature keys). A Fabric OS switch becomes a dumb switch when the authentication is configured to Off (See previous section for a description of Fabric OS switch authentication Off conditions). How authentication is affected when the M-EOS switch does not have the feature keys enabled is discussed in this section.

[Table 63](#) on page 316 shows how authentication is affected when a Fabric OS switch is connected to a dumb M-EOS switch.

**TABLE 63 Switch authentication policy when connected to an M-EOS dumb switch**

Fabric OS	Passive	Active	On	Off
M-EOS				
Disabled	Yes Connected without any authentication (Fabric builds normally).	No E_Port does not connect (Authentication Rejected). When the Fabric OS switch generates the reject, it disables the Fabric OS port. When the M-EOS switch generates the reject, it goes to an invalid attachment state.	No E_Port does not connect (Authentication Rejected). When the Fabric OS switch generates the reject, it disables the Fabric OS port. When the M-EOS switch generates the reject, it goes to an invalid attachment state.	Yes Connected without any authentication (Fabric builds normally).

Because the M-EOS switch does not know about authentication, there is never an authenticated connection made. However, the E\_Port is established when the Fabric OS switch is configured in Passive or Off states. The cases where the connection fails are when the Fabric OS switch is configured as On or Passive. This is because these states require the authentication of the E\_Ports to respond to authentication requests. See [Table 57](#) on page 312 for the Fabric OS mode descriptions. The Passive and Off cases never exchange authentication frames, and therefore come up as normal E\_Ports.

## Authentication of EX\_Port, VE\_Port, and VEX\_Port connections

VE\_Ports run authentication the same as E\_Ports; for information on authenticating E\_Ports, see [“E\\_Port authentication between Fabric OS and M-EOS switches”](#) on page 311.

EX\_Ports and VEX\_Ports both run authentication in Passive mode. This means these ports will not initiate authentication, but they will respond to authentication requests initiated by the connecting switch. Changing the switch authentication policy mode does not affect the authentication function of EX\_Ports; they remain in Passive mode.

If you connect an M-EOS switch in On mode to an EX\_Port set to McDATA Open Fabric mode or McDATA Fabric mode, authentication should work the same as connecting an M-EOS switch to a Fabric OS switch in Passive mode. The authenticated connection is successful if the M-EOS switch has the correct secret for the Fabric OS switch and the Fabric OS switch has the correct secret for the M-EOS switch.

### NOTE

The EX\_Port's secret is configured on the Fabric OS switch the same way it is configured for an E\_Port. However, the front domain WWN should be used to install the shared secret on the E\_Port side.

M-EOS switches do not support VE\_Port or VEX\_Port connections; any configurations with these port types are Fabric OS-only configurations. However, both VE and VEX\_Ports support running in McDATA interop mode.

## Authentication of VE\_Port-to-VE\_Port connections

Although running authentication for VE\_Ports works the same as for E\_Ports, for VE\_Ports, both sides of the connection are on the Fabric OS switches. Table 64 shows the switch authentication policy for VE\_Port-to-VE\_Port connections when all the secrets are correct. Note that there is no \*Yes in the table indicating one-way authentication. This is because Fabric OS switches always perform authentication even when in Passive mode. Table 64 shows the switch authentication policy for a VE\_Port connected to another VE\_Port when the secrets are not known. In this case, two-way authentication by the Fabric OS switches means that no authenticated connections are going to be made.

**TABLE 64** VE\_Port-to-VE\_Port authentication policy with correct switch secret

Fabric OS switch VE_ to VE_Port	Passive	Active	On	Off
Passive	Yes Connected without any authentication (Fabric builds normally).	Yes! Connected with two-way authentication; both sides of the connection perform Authentication (Fabric builds normally).	Yes! Connected with two-way authentication; both sides of the connection perform Authentication (Fabric builds normally).	Yes Connected without any authentication (Fabric builds normally).
Active	Yes! Connected with two-way authentication; both sides of the connection perform authentication (Fabric builds normally).	Yes! Connected with two-way authentication; both sides of the connection perform authentication (Fabric builds normally).	Yes! Connected with two-way authentication; both sides of the connection perform authentication (Fabric builds normally).	No E_Port does not connect (Authentication Rejected). When the Fabric OS switch generates the reject, it disables the Fabric OS port. When the M-EOS switch generates the reject, it goes to an invalid attachment state.

# 14 E\_Port authentication between Fabric OS and M-EOS switches

**TABLE 64 VE\_Port-to-VE\_Port authentication policy with correct switch secret (Continued)**

Fabric OS switch VE_ to VE_Port	Passive	Active	On	Off
On	Yes! Connected with two-way authentication; both sides of the connection perform authentication (Fabric builds normally).	Yes! Connected with two-way authentication; both sides of the connection perform authentication (Fabric builds normally).	Yes! Connected with two-way authentication; both sides of the connection perform authentication (Fabric builds normally).	No E_Port does not connect (Authentication Rejected). When the Fabric OS switch generates the reject, it disables the Fabric OS port. When the M-EOS switch generates the reject, it goes to an invalid attachment state.
Off	Yes Connected without any authentication (Fabric builds normally).	No E_Port does not connect (Authentication Rejected). When the Fabric OS switch generates the reject, it disables the Fabric OS port. When the M-EOS switch generates the reject, it goes to an invalid attachment state.	No E_Port does not connect (Authentication Rejected). When the Fabric OS switch generates the reject, it disables the Fabric OS port. When the M-EOS switch generates the reject, it goes to an invalid attachment state.	Yes Connected without any authentication (Fabric builds normally).

**TABLE 65** VE\_Port-to-VE\_Port authentication policy with unknown switch secret

Fabric OS switch VE_ to VE_Port	Passive	Active	On	Off
Passive	Yes Connected without any authentication (Fabric builds normally).	No E_Port does not connect (Authentication Rejected). When the Fabric OS switch generates the reject, it disables the Fabric OS port. When the M-EOS switch generates the reject, it goes to an invalid attachment state.	No E_Port does not connect (Authentication Rejected). When the Fabric OS switch generates the reject, it disables the Fabric OS port. When the M-EOS switch generates the reject, it goes to an invalid attachment state.	Yes Connected without any authentication (Fabric builds normally).
Active	No E_Port does not connect (Authentication Rejected). When the Fabric OS switch generates the reject, it disables the Fabric OS port. When the M-EOS switch generates the reject, it goes to an invalid attachment state.	No E_Port does not connect (Authentication Rejected). When the Fabric OS switch generates the reject, it disables the Fabric OS port. When the M-EOS switch generates the reject, it goes to an invalid attachment state.	No E_Port does not connect (Authentication Rejected). When the Fabric OS switch generates the reject, it disables the Fabric OS port. When the M-EOS switch generates the reject, it goes to an invalid attachment state.	No E_Port does not connect (Authentication Rejected). When the Fabric OS switch generates the reject, it disables the Fabric OS port. When the M-EOS switch generates the reject, it goes to an invalid attachment state.

**TABLE 65 VE\_Port-to-VE\_Port authentication policy with unknown switch secret (Continued)**

Fabric OS switch VE_ to VE_Port	Passive	Active	On	Off
On	No E_Port does not connect (Authentication Rejected). When the Fabric OS switch generates the reject, it disables the Fabric OS port. When the M-EOS switch generates the reject, it goes to an invalid attachment state.	No E_Port does not connect (Authentication Rejected). When the Fabric OS switch generates the reject, it disables the Fabric OS port. When the M-EOS switch generates the reject, it goes to an invalid attachment state.	No E_Port does not connect (Authentication Rejected). When the Fabric OS switch generates the reject, it disables the Fabric OS port. When the M-EOS switch generates the reject, it goes to an invalid attachment state.	No E_Port does not connect (Authentication Rejected). When the Fabric OS switch generates the reject, it disables the Fabric OS port. When the M-EOS switch generates the reject, it goes to an invalid attachment state.
Off	Yes Connected without any authentication (Fabric builds normally).	No E_Port does not connect (Authentication Rejected). When the Fabric OS switch generates the reject, it disables the Fabric OS port. When the M-EOS switch generates the reject, it goes to an invalid attachment state.	No E_Port does not connect (Authentication Rejected). When the Fabric OS switch generates the reject, it disables the Fabric OS port. When the M-EOS switch generates the reject, it goes to an invalid attachment state.	Yes Connected without any authentication (Fabric builds normally).

### Authentication of VEX\_Port-to-VE\_Port connections

VEX\_Port authentication is basically the same as EX\_Port authentication. VEX\_Ports always operate in Passive mode. This means that a VEX\_Port connected to a VE\_Port works the same as an E\_Port connected to an EX\_Port. The Fabric OS switch is on both sides of the connection.

[Table 66](#) shows the switch authentication policy for a VEX\_Port connected to a VE\_Port.



**TABLE 66 VEX\_Port-to-VE\_Port authentication policy with correct secrets**

Fabric OS switch VEX_Port-to-VE_Port	Passive	Active	On	Off
Passive	Yes Connected without any authentication (Fabric builds normally).	Yes! Connected with two-way authentication; both sides of the connection perform Authentication (Fabric builds normally).	Yes! Connected with two-way authentication; both sides of the connection perform Authentication (Fabric builds normally).	Yes Connected without any authentication (Fabric builds normally).

**TABLE 67 VEX\_Port-to-VE\_Port authentication policy when secrets are not correct**

Fabric OS switch VEX_Port-to-VE_Port	Passive	Active	On	Off
Passive	Yes Connected without any authentication (Fabric builds normally).	No E_Port does not connect (Authentication Rejected). When the Fabric OS switch generates the reject, it disables the Fabric OS port. When the M-EOS switch generates the reject, it goes to an invalid attachment state.	No E_Port does not connect (Authentication Rejected). When the Fabric OS switch generates the reject, it disables the Fabric OS port. When the M-EOS switch generates the reject, it goes to an invalid attachment state.	Yes Connected without any authentication (Fabric builds normally).

## Authentication of VEX\_Port-to-VEX\_Port connections

Connecting VEX\_Ports to each other is not relevant for authentication, because both ports will always operate in Passive mode. Because ports in Passive mode do not initiate authentication, VEX\_Ports cannot have an authenticated connection between them.

## FCR SANtegrity

FC-FC Routing (FCR) SANtegrity is supported for Fabric Binding when EX\_Ports are attached to a McDATA edge switch. Fabric Binding lets you configure a Fabric Binding Membership list that each switch in a fabric can use to validate between it and its neighbor. McDATA SANtegrity Fabric Binding uses a list made up of domain ID and WWN pairs and implies the use of Insistent Domain IDs. When Fabric Binding is enabled, a Fabric Binding check is performed each time a link is enabled to ensure that the switches can connect. If the binding check fails, the McDATA port goes to an invalid attachment state and the EX\_Port disables itself.

### NOTE

After a Fabric Binding check failure between a McDATA E\_Port and an EX\_Port, the current M-EOS implementation requires you to disable the M-EOS port and then re-enable it before the link can come up again. Enabling just the EX\_Port does not always allow the link to come up again.

FCR implements a simplified version of Fabric Binding that is passive and only checks whether its own Front Port domain ID and WWN pair is present in the Fabric Binding list that is sent from an M-EOS switch.



#### CAUTION

**In FOS-only McDATA Fabric Mode fabrics that have Fabric Binding activated, fabric disruptions may occur if there are any FOS switches that do not have insistent domain ID enabled.**

Fabric Binding activation or deactivation is a fabric-wide event. Unlike Layer 2 SANtegrity, FCR requires additional configurations that you must perform from the command line before configuring and enabling Fabric Binding using DCFM. You must configure the preferred domain ID.

## Fabric Binding behavior in a mixed fabric

The front port preferred domain ID behaves as insistent while Fabric Binding is enabled. Fabric Binding must be disabled while the EX\_Port is part of the edge fabric prior to removing an EX\_Port from a bound fabric to disable the Insistent Domain ID behavior on that EX\_Port. Failure to do this results in Insistent Domain ID behavior of the EX\_Port even if it is subsequently connected to an edge fabric that is not using Fabric Binding.

M-EOS Fabric Binding uses a list made up of domain ID and WWN pairs. Because the FCR front port WWN cannot be predetermined, you must connect the FCR to the M-EOS edge switch before the Fabric Binding List can be filled in with the FCR front port domain ID and WWN entry. If you downgrade to a Fabric OS version that does not support SANtegrity interoperability without first disabling Fabric Binding, the ports will segment upon subsequent initialization.

When an FC router is attached through an EX\_Port to an edge fabric, it creates a translate domain in the fabric corresponding to the remote edge fabrics with active logical storage area networks (LSANs) defined. In this case:

- Translate domains that are already present before Fabric Binding is enabled must be included in the Fabric Binding List created using DCFM.
- Translate domains that are created after Fabric Binding is enabled do not have to be added to the Fabric Binding List and do not cause any Fabric Binding checks to fail. If Fabric Binding is subsequently disabled, these translate domains must be added to the Fabric Binding List before Fabric Binding can be re-enabled.

Translate domains do not have Preferred or Insistent Domain ID behavior.

## Configuring the preferred domain ID and the insistent domain ID

The preferred domain ID must be configured in order for Fabric Binding to work even if it matches the default value. The configured preferred domain ID becomes insistent whenever Fabric Binding is enabled. If the EX\_Port is part of the edge fabric, Fabric Binding must be disabled before you can remove the EX\_Port from the Fabric Binding to be able to disable the Insistent Domain ID (IDID).

---

#### NOTE

In McDATA Open Fabric mode, it is possible to configure a preferred domain ID outside of the range allowed for an M-EOS switch. The preferred domain ID must be configured in the range of 97-127 in Open Fabric mode or Fabric Binding fails to activate.

---

1. Connect to the switch and log in using an account assigned to the admin role.  
Ensure that the port is offline to configure the preferred domain ID.
2. Enter the **portCfgEXPort** command.  
For McDATA Fabric mode, the valid range of domain IDs is from 1-31. For McDATA Open Fabric mode, the valid range of domain IDs is from 97-127. For example, to set preferred domain ID to 5 on port 2 in McDATA Fabric mode:  

```
switch:admin> portcfgexport 2 -d 5
```
3. Enable the EX\_Port.  
If the port is not already set to McDATA Fabric mode, you can also use **portCfgEXPort -m portmode** to set the mode. Valid values for *portmode* are 1 for McDATA Open Fabric mode and 2 for McDATA Fabric mode.

**NOTE**

This mapping between mode values and modes is NOT the same as the mapping used when setting interoperability modes using the **interopMode** command.

## FICON implementation in a mixed fabric

You can perform remote CUP operations on two or more switches, or backbone platforms, where the switches are connected as a single Fabric through an E\_Port. If the channel times out before getting a response from the CUP, you can set the value to specify when the channel should time out.

All switches in the fabric must have **interopmode** set to 2.

**NOTE**

Logical switches can be configured for FICON CUP on the 48-port blades in the Brocade DCX and the DCX-4S.

For information on how to display the FICON-CUP parameters and how to change the MIHPTO value to 60 for interoperable fabrics, see the *FICON Administrator's Guide*.

## Fabric OS version change restrictions in an interoperable environment

The following restrictions apply when upgrading and downgrading firmware to a switch set to interopmode 2 or 3:

- Downgrading from Fabric OS v6.3.0 is allowed only when a switch is in the default Domain\_ID mode because this is only supported in Fabric OS v6.2.0. In other offset modes, downgrading is not allowed.
- Upgrading to Fabric OS v6.4.0 does not automatically synchronize the Defined Database with other switches in the fabric. You must select one switch and run the **cfgSave** command.

## Coordinated Hot Code Load

Coordinated Hot Code Load (HCL) removes the limitations on the number of E\_Ports that can be supported. Fabric OS v6.2.0 and later supports Coordinated HCL on all Fabric OS switches when connected to a mixed fabric with M-EOS switches running in either McDATA Fabric or McDATA Open Fabric mode. Coordinated HCL provides:

- Fabric-wide pause and resume
- No limitations on E\_Port count or fabric membership
- Flood pause frame to all switches in the fabric before initiating a reboot

Fabric OS running on switches takes approximately 120 seconds to restart as part of the Hot Code Activation process. During the 120 seconds when the Fabric OS switches are waiting to restart and the switch service is not available, the M-EOS switches in the fabric may send point-to-point frames and domain controller frames (GEPT) to the Fabric OS switches. A Fabric OS v6.3.0 switch notifies all switches in the fabric about a pending Hot Code Activation so that they can stop sending control frames to the specified switch until it restarts and sends a resume notification. When the switch initiates a graceful shutdown sequence to prepare for Hot Code load, it sends a Pause notification frame that support Coordinated HCL switches in the fabric. When the specified switch restarts it sends out a resume notification.

### Bypassing the Coordinated HCL check on firmware download

When you download the Fabric OS firmware on switches in interoperable fabrics, it automatically starts the Coordinated HCL. The **firmwareDownload** command checks whether all switches in the fabric support Coordinated HCL. If Coordinated HCL is supported, the **firmwareDownload** operation proceeds and displays the normal message. If Coordinated HCL is not supported, the **firmwareDownload** operation fails and prompts you to use the **-o** option to bypass checking the Coordinated HCL. All domains are not capable of supporting Coordinated HCL.

On switches in interop fabrics, the Coordinated HCL protocol is used to ensure data traffic is not disrupted during firmware upgrades. Using the **firmwareDownload** with the **-o** allows the firmware download to continue even if Coordinated HCL is not supported in the fabric or the protocol fails.

1. Enter the **firmwareDownload** command without any option to automatically start Coordinated HCL.

If Coordinated HCL is not supported, the **firmwareDownload** operation fails and prompts you to use the **-o** option to bypass checking the Coordinated HCL. All domains are not capable of supporting Coordinated HCL.

Firmwaredownload is not running at that point.

2. Enter **firmwareDownload -o** to continue the download.

If Coordinated HCL is not supported in the fabric or if there is an Coordinated HCL protocol failure to one or more of the supported switches, a best effort is made to run the Coordinated HCL protocol. Traffic disruption can still occur for some switches in the fabric.

The normal firmwaredownload messages are displayed along with the following message:

```
You have elected to bypass the checking of Coordinated HCL. This may cause
traffic disruption for some switches in the fabric.
Do you want to proceed?
```

If you select **yes**, the **firmwareDownload** operation proceeds without making the normal Coordinated HCL checks.

The **firmwareDownload -o** command upgrades both CPs in the switch.

## Coordinated HCL on switches firmware downloads

If the **firmwareDownload** command is entered with both the **-s** and **-b** (auto-reboot) options, a best effort will be made to run Coordinated HCL. If one or more switches in the fabric do not support Coordinated HCL, the firmware download process will still continue. If the **firmwareDownload** command is entered with **-s**, but without the **-b** (auto-reboot) option, Coordinated HCL will not run.

## Upgrade and downgrade considerations for HCL for interoperability

Following are the upgrade and downgrade considerations for Coordinated HCL for McDATA Fabric mode and McDATA Open Fabric mode. This list does not consider upgrades or downgrades from Brocade Native mode.

- Downgrading from Fabric OS v6.4.0 to a previous release is nondisruptive.
- Coordinated HCL does not affect director-class and backbone platform products because of their fast switch-over capability.

## McDATA-aware features

If a feature is *McDATA-aware* (that is, aware of the McDATA environment), some actions may be possible fabric-wide. If a feature is *M-EOS-unaware*, some actions cannot be taken.

[Table 68](#) describes McDATA-aware features.

**TABLE 68** McDATA-aware features

Feature	Behavior
ASIC	The header of FC frames uses the SID and DID according to the domain offset setting.
Brocade management interfaces such as DCFM and Web Tools	Allows configuring stand-alone and fabric-wide tasks such as basic switch and port operations.
Coordinated Hot Code Load (HCL)	Supported in McDATA Open Fabric mode and McDATA Fabric mode.
ESS	Displays the firmware version in the M-EOS format as 9.7.2, and the Fabric OS format as v6.4.0.
Fabric	In a mixed configuration, the fabric issues ESC exchange to determine the domain ID offset setting of adjacent switches. An incompatible domain ID offset causes ISLs to segment. The fabric also auto-negotiates the credit model usage: R-RDY for connection to an M-EOS switch and VC-RDY for connection to a Fabric OS switch.
FC	Converts the header of FC frames to use the correct SID and DID according to the domain offset setting.
FCR E_Port SANtegrity	Supported in McDATA Open Fabric mode and McDATA Fabric mode.
FCR Fabric OS Level 2 (Layer 2 SANtegrity)	Supported in McDATA Fabric mode and McDATA Open Fabric mode.

**TABLE 68 McDATA-aware (Continued)features**

Feature	Behavior
FICON and FICON CUP	Fabric Binding is required for FICON support in mixed fabrics. Cascaded CUP and Missing Interrupt Handler Process Timeout (MIHPTO), which should be set to 60, are supported. Cascaded CUP is only supported in McDATA Fabric mode.
Long distance	The <b>configure</b> command displays the number of buffer credits allocated to a port.
Name server (nsShow, nsCamShow, nsAllShow)	Displays the device PID with domain offset. For example, a host attached to a switch with domain value 1 will have a default PID of 0x61AAPP.
Zone activation	In McDATA Fabric mode, zone activations can be performed from any switch. In McDATA Open Fabric mode, zone activations can be performed from an M-Series management tool, such as the Brocade Data Center Fabric Manager (DFCM) management tool.

## McDATA-unaware features

Table 69 describes features that are unaware of M-EOS switches or fabrics and cannot be used fabric-wide.

**TABLE 69 McDATA-unaware features**

Feature	Support
Security	
ACL in strict mode	Not supported.
ACL in non-strict (Tolerant) mode, Absent mode, and others (such as password authentication)	Supported.
Admin Domains	Not supported.
Fabric-wide diagnostics (FC-Ping, PathInfo)	Not supported.

Table 70 describes a comprehensive matrix of feature support.

**TABLE 70 Complete feature compatibility matrix**

Feature	Support	Notes
Access Control List	<ul style="list-style-type: none"> <li>ACL in strict mode: No</li> <li>ACL in tolerant mode: Yes</li> <li>ACL in absent mode: Yes</li> </ul>	Works with SANtegrity.
Admin domains	No	
Advanced Performance Monitoring	No	
Audit	Yes	
Beaconing	Yes	
Configuration download/upload	Yes	

TABLE 70 Complete feature compatibility matrix (Continued)

Feature	Support	Notes
DHCP	Yes	
Environmental monitor	Yes	
Error event management	Yes	
Fabric Device Management Interface (FDMI)	Yes	
Fabric Watch (FW)	Yes	
Fibre Channel over Ethernet (FCoE)	No	McDATA Fabric mode and McDATA Open Fabric mode are not supported on the Brocade 8000.
FICON (includes CUP)	No	Supported on the Brocade 4900, 5000, 5100, 5300, and the VA-40FC switches, and the Brocade 48000 and the Brocade DCX Backbone. <b>Note:</b> All switches must be running FOS v6.1.0 or later to support this feature.
High Availability (HA)	Yes	Coordinated Hot Code Load in Fabric OS v6.1.0.
Interoperability	<ul style="list-style-type: none"> <li>• Fabric OS Native mode: No</li> <li>• McDATA Open mode: Yes</li> <li>• McDATA Fabric mode: Yes</li> </ul>	
IP over FC	Yes	Works on a local Fabric OS switch. Broadcast frames are sent to F_Ports only; there is no forwarding of broadcast frames to E_Ports.
License	Yes	
Log tracking	Yes	
Long-distance fabrics	Yes	The <b>configure</b> command displays the number of buffer credits.
Management server	Yes	FICON Management Server supported in McDATA Fabric mode.
Manufacturing diagnostics	Yes	
N_Port ID Virtualization	Yes	The tested limits for NPIV are 24 NPIV channels multiplied by 12 virtual port logins.
Name server	Yes	Support Domain offset, McDATA specific SWRSCN, FCFG commands (GE_PT, GSNN_NN, GSPN_ID, and GA_NXT).
Network Time Protocol (NTP)	No	
Open E_Port	Yes	Autonegotiates the R_RDY mode by default. Uses <b>portCfgIsMode</b> to static configure the port.
Port mirroring	Yes	Fabric OS v6.2.0 and later supports 8 Gbps port mirroring.
SNMP	Yes	

TABLE 70 Complete feature compatibility matrix (Continued)

Feature	Support	Notes
Speed negotiation	Yes	
syslog daemon	Yes	
QoS	No	
Trunking	<ul style="list-style-type: none"> <li>• Frame-level ISL Trunking from Fabric OS to Fabric OS: Yes; McDATA Fabric mode only</li> <li>• Frame-level ISL Trunking from Fabric OS to M-EOS: No</li> <li>• Load balancing from Fabric OS to Fabric OS using DLS or DPS: Yes</li> <li>• Load balancing from Fabric OS to M-EOS using DLS or DPS: Yes</li> </ul>	
Value Line Options (Static POD, DPOD)	Yes	
Virtual fabrics	Yes	
Web Tools	Yes	Launch from DCFM with non fabric-wide configuration.
Zoning	Yes for McDATA Fabric mode only	Allows fabric-wide activation of zone configurations in McDATA Fabric mode and McDATA Open Fabric mode. No zoning management in Fabric OS switch except <b>cfgClear</b> and <b>cfgDisable</b> after a switch is disabled. Regular zones cannot be configured on Fabric OS switches.

## M-EOS feature limitations in mixed fabrics

The following features have inherent limitations:

- Port number offset
 

Some M-EOS switches assign PIDs with an area field (the middle byte of the PID) that has an offset of four added to the port number. This means, for example, that the physical port number (zero) 0 has an address value used in the PID of 4.

The port number offset is conveyed between the neighboring switches through the ESS ILS (Exchange Security Attributes), allowing neighboring switches to accurately identify port numbers and their associated PIDs. The maximum port number is also available in the ESS ILS.
- NPIV
 

NPIV management on the Fabric OS switch is the same as in the standard Fabric OS SAN that is not merged. There are no limitations for NPIV support in an M-EOS Fabric 1.0 mode fabric.



- **Trunking**

Fabric OS switches support trunking when participating in Brocade Native, McDATA Fabric, or McDATA Open Fabric mode. Trunk ports (bandwidth aggregation) only apply to an ISL between two Fabric OS switches. Note the following:

  - **Fabric OS frame-based trunking**

Fabric OS frame-based trunking is supported for ISLs between two Fabric OS switches. Multiple ISLs between a Fabric OS switch and an M-EOS type switch are allowed, but no frame-based trunking occurs.
  - **Fabric OS exchange-level trunking (DPS) and source-port route balancing (DLS)**

These are supported for connections between Fabric OS switches and M-EOS switches.
  - **M-EOS Open Trunking**

This is supported for outbound ISLs from any M-EOS switch to any switch in the fabric.
- **Domain ID offset configuration**

When installing Brocade switches to an existing McDATA fabric, this feature allows different fabrics to have different ranges and expands the range of domains that Fabric OS switches support in interopmodes 2 and 3. It does not increase the maximum number (31) of switches in a fabric. Note the following:

  - **Domain ID offset configuration is used by M-EOS switches in assigning the first byte of the PID for attached end devices. McDATA Fabric mode supports a domain ID range from 1 to 31 and McDATA Open Fabric mode supports a domain ID range of 97-127; the starting offset of this range of domain IDs can be modified. The offset value, which changes the range in a multiple of 31, is added to the actual domain ID of the switch and is used in assigning the PID. Traditionally, M-EOS-based switches used an offset of 96. For example, a switch with a domain ID configured to 3 would assign a value of 99 to the first byte of all PIDs and the domain ID range would be 97-127.**
  - **Domain ID offset configuration changes affect the domain ID, so all actions associated with this change must also be made to the domain ID.**
  - **In addition to implementing this feature using the CLI, you can also use DCFM, Web Tools, or any other user interface, but the domain ID offset must be consistent among all the user interfaces.**

For instructions to convert decimal numbers to hexadecimal, refer to [Appendix E, "Hexadecimal"](#).

## Supported hardware in an interoperable environment

The following matrix identifies the Fabric OS hardware platforms that are interoperable with M-EOS hardware platforms. McDATA Fabric mode and McDATA Open Fabric mode are not supported on the Brocade 8000.

# 14 Supported hardware in an interoperable environment

**TABLE 71 Fabric OS interoperability with M-EOS**

		Fabric OS v6.2.0	Fabric OS v6.3.0	Fabric OS v6.4.0
Chassis Type	Blade Type	McDATA Open Fabric and Fabric mode	McDATA Open Fabric and Fabric mode	McDATA Open Fabric and Fabric mode
Brocade 48000 director	16/32/48 port -4G	Yes	Yes	Yes
	10G	Yes	Yes	Yes
	16/32/48 port -8G	Yes	Yes	Yes
	FC4-16IP	Yes	Yes	Yes
	FR4-18i	Yes	Yes	Yes
	FA4-18	Yes	Yes	Yes
Brocade DCX Backbone	FC8-16/32/48/64 <sup>1</sup>	Yes	Yes	Yes
	10G	Yes	Yes	Yes
	FC4-16IP	Yes	Yes	Yes
	FR4-18i	Yes	Yes	Yes
	FA4-18	Yes	Yes	Yes
	FS8-18	Yes	Yes	Yes
Brocade DCX-4S	FX8-24	No	Yes	Yes
	FC8-16/32/48/64 <sup>1</sup>	Yes	Yes	Yes
	FC10-6	Yes	Yes	Yes
	FR4-18i	Yes	Yes	Yes
	FA4-18	Yes	Yes	Yes
	FS8-18	Yes	Yes	Yes
Switches and Appliances	FX8-24	No	Yes	Yes
	Brocade 300	Yes	Yes	Yes
	Brocade 4100	No	No	No
	Brocade 4900	Yes	Yes	Yes
	Brocade 5000	Yes	Yes	Yes
	Brocade 5100	Yes	Yes	Yes
	Brocade 5300	Yes	Yes	Yes
	Brocade 7500 and 7500E	Yes	Yes	Yes
	Brocade 7600	Yes	Yes	Yes
	Brocade 7800	No	Yes	Yes
	Brocade 8000	No Not blocked by software.	No Not blocked by software.	No
	Brocade Encryption Switch	Yes	Yes	Yes

TABLE 71 Fabric OS interoperability with M-EOS (Continued)

	Fabric OS v6.2.0	Fabric OS v6.3.0	Fabric OS v6.4.0	
Chassis Type	Blade Type	McDATA Open Fabric and Fabric mode	McDATA Open Fabric and Fabric mode	McDATA Open Fabric and Fabric mode
Brocade VA-40FC				
Embedded Server Switches				
3016				
5410				
5424				
5450				
5480				
M-EOS Hardware				
Mi10K				
M6140				
M6064				
M-EOS Switches				
4300				
4400				
4500				
4700				
3032				
3232				
3216				
<b>Note:</b> The M1620 and M2460 are no longer supported as part of a mixed fabric and there is no support for routing with these two platforms. Also, there is no support for Qlogic blades.				

1. The FC8-64 blade is only supported in Fabric OS v6.4.0.

## Supported features in an interoperable environment

Table 72 shows the interoperability features supported in Fabric OS v6.2.0, v6.3.0, and v6.4.0.

**TABLE 72 Supported Fabric OS features**

Fabric OS Features	Fabric OS v6.2.0		Fabric OS v6.3.0 and v6.4.0	
	Interop mode 2	Interop mode 3	Interop mode 2	Interop mode 3
Dynamic Load Sharing (DLS); port based routing	Yes	Yes	Yes	Yes
Dynamic Path Selection (DPS); exchange based routing	Yes Supported outbound from Fabric OS-based switches. M-EOS can provide reciprocal load balancing using OpenTrunking.	Yes Supported outbound from Fabric OS-based switches. M-EOS can provide reciprocal load balancing using OpenTrunking.	Yes Supported outbound from Fabric OS-based switches. M-EOS can provide reciprocal load balancing using OpenTrunking.	Yes Supported outbound from Fabric OS-based switches. M-EOS can provide reciprocal load balancing using OpenTrunking.
E/EX_Port Authentication	Yes	Yes	Yes	Yes
Extended Fabrics	Yes	Yes Not on FCR	Yes	Yes Not on FCR
Fabric OS Coordinated HCL with FCR	Yes	Yes	Yes	Yes
Fabric Watch	Yes	Yes	Yes	Yes
FC10-6 -to-FC10-6 ISL	Yes	Yes	Yes	Yes
FCIP (VE_Ports)	Yes	Yes	Yes	Yes
FCR Fabric Binding (route to M-EOS fabric with Fabric binding)	Yes	Yes	Yes	Yes
FICON Management Server (Cascading)	Yes	Yes	Yes	Yes
FICON MIHPTO	Yes	No	Yes	No
Frame Redirection (devices attached to Fabric OS)	Yes	Yes	Yes	Yes
Full Scalability (to maximum M-EOS fabric limits)	Yes	Yes	Yes	Yes
Integrated Routing	Yes	Yes	Yes	Yes
IPFC (IP over FC)	Yes Only supported locally within the Fabric OS switch.	Yes Only supported locally within the Fabric OS switch.	Yes Only supported locally within the Fabric OS switch.	Yes Only supported locally within the Fabric OS switch.
ISL Trunking (frame-level)	Yes Only allowed between Fabric OS-based switches.	Yes Only allowed between Fabric OS-based switches.	Yes Only allowed between Fabric OS-based switches.	Yes Only allowed between Fabric OS-based switches.

**TABLE 72 Supported Fabric OS features (Continued)**

Fabric OS Features	Fabric OS v6.2.0		Fabric OS v6.3.0 and v6.4.0	
	Interop mode 2	Interop mode 3	Interop mode 2	Interop mode 3
Layer 2 Fabric Binding	Yes	Yes	Yes	Yes
Layer 2 Fabric OS Coordinated Hot Code Load (HCL)	Yes	Yes	Yes	Yes
M-EOS AL_PA 0x13 configuration	Yes	Yes	Yes	Yes
Masterless F_Port Trunking (Access Gateway connects to Fabric OS switches only)	Yes	Yes	Yes	Yes
NPIV	Yes	Yes	Yes	Yes
Open E_Port	N/A	N/A	N/A	N/A
Port Mirroring (8 Gbps port mirroring supported in Fabric OS v6.2.0)	Yes	Yes	Yes	Yes
Ports on Demand (POD)	No	No	No	No
RASLOG Events on duplicate WWNs	Yes	Yes	Yes	Yes
SCC policies	Yes Only supported in conjunction with Layer 2 Fabric Binding.	No In Virtual Fabrics, ACL policies such as DCC, SCC and FCS can be configured on per logical switch basis.	Yes Only supported in conjunction with Layer 2 Fabric Binding.	No In Virtual Fabrics, ACL policies such as DCC, SCC and FCS can be configured on per logical switch basis.
Traffic Isolation zones	Yes	Yes	Yes	Yes
VE-to-VEX Port	Yes	Yes	Yes	Yes
Virtual Channels (VC RDY)	Yes Only allowed between Fabric OS-based switches.	Yes Only allowed between Fabric OS-based switches.	Yes Only allowed between Fabric OS-based switches.	Yes Only allowed between Fabric OS-based switches.
Zone Activation support	Yes	No	Yes	Yes

# Unsupported features in an interoperable environment

The following optional features are not supported in McDATA Fabric and McDATA Open Fabric modes and cannot be installed on any Fabric OS switch in the fabric:

- Administrative Domains
- Quickloop and QuickLoop Zoning
- Timer Server function
- Open E\_Port
- Broadcast Zoning
- Management Server service and FDMI
- Alias Server
- Platform services
- Top Talkers
- Advanced Performance Monitoring

# Managing Administrative Domains

---

## In this chapter

- [Administrative Domains overview](#) ..... 335
- [Admin Domain management for physical fabric administrators](#) ..... 344
- [SAN management with Admin Domains](#) ..... 356

## Administrative Domains overview

An *Administrative Domain* (Admin Domain or AD) is a logical grouping of fabric elements that defines which switches, ports, and devices you can view and modify. An Admin Domain is a filtered administrative view of the fabric.

---

### NOTE

If you do not implement Admin Domains, the feature has no impact on users and you can ignore this chapter.

---

Admin Domains permit access to a configured set of users. Using Admin Domains, you can partition the fabric into logical groups and allocate administration of these groups to different user accounts. These accounts manage only the Admin Domains assigned to them and do not make changes to the rest of the fabric.

For example, you can put all the devices in a particular department in the same Admin Domain for ease of managing those devices. If you have remote sites, you could put the resources in the remote site in an Admin Domain and assign the remote site administrator to manage those resources.

Admin Domains and Virtual Fabrics are mutually exclusive and are not supported at the same time on a switch.

Do not confuse Admin Domains with zones:

- Zones define which devices and hosts can communicate with each other.
- Admin Domains define which users can manage which devices, hosts, and switches.

You can have up to 256 Admin Domains in a fabric (254 user-defined and 2 system-defined), numbered from 0 through 255. Admin Domains are designated by a name and a number. This document refers to specific Admin Domains using the format “AD $n$ ” where  $n$  is a number between 0 and 255.

---

### NOTE

Do not confuse an *Admin Domain number* with the *domain ID of a switch*. They are two different identifiers. The Admin Domain number identifies the Admin Domain and has a range of 0–255. The domain ID identifies a switch in the fabric and has a range of 1–239.

---

[Figure 51](#) on page 336 shows a fabric with two Admin Domains: AD1 and AD2.

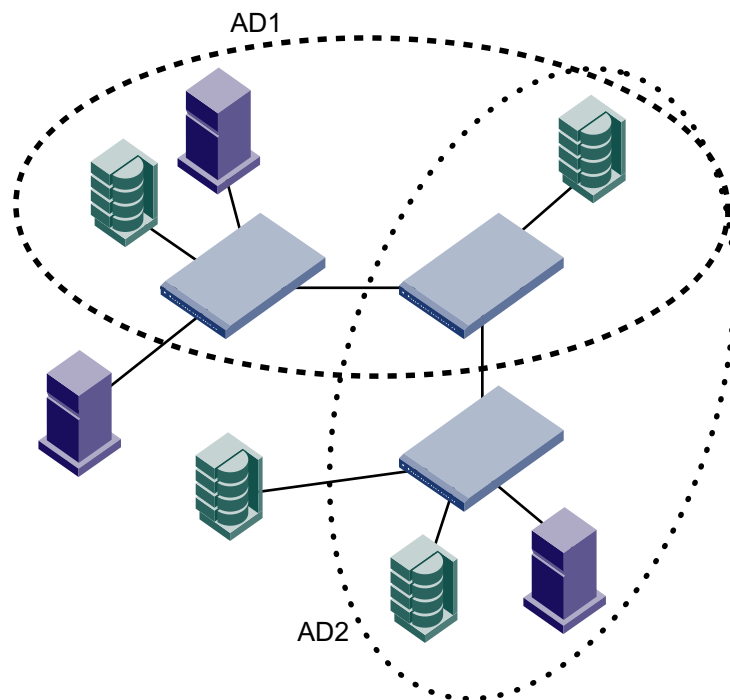

**FIGURE 51** Fabric with two Admin Domains

Figure 52 shows how users get a filtered view of this fabric, depending on which Admin Domain they are in. As shown in Figure 52, users can see all switches and E\_Ports in the fabric, regardless of their Admin Domain; however, the switch ports and end devices are filtered based on Admin Domain membership.

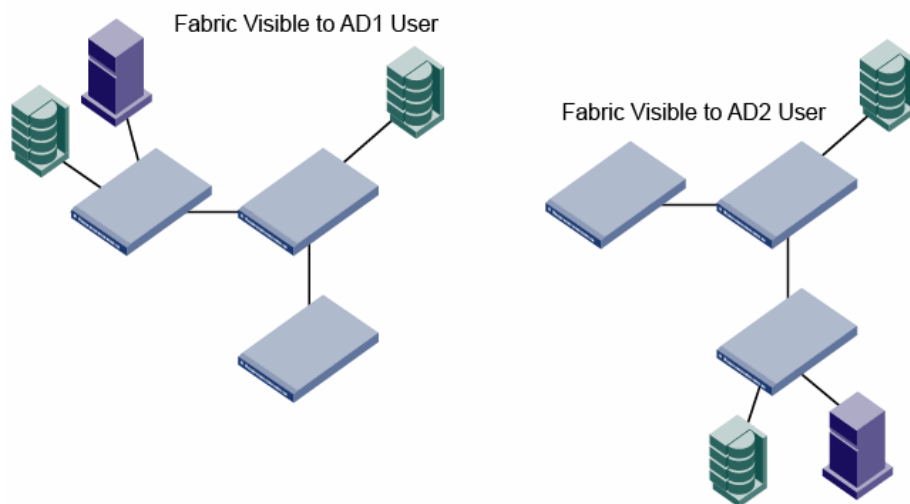

**FIGURE 52** Filtered fabric views when using Admin Domains



## Admin Domain features

Admin Domains allow you to:

- Define the scope of an Admin Domain to encompass ports and devices within a switch or a fabric.
- Share resources across multiple Admin Domains. For example, you can share array ports and tape drives between multiple departments. In [Figure 51](#) on page 336, one of the storage devices is shared between AD1 and AD2.
- Have a separate zone database for each Admin Domain. See [“Admin Domains, zones, and zone databases”](#) on page 360 for more information.
- Move devices from one Admin Domain to another without traffic disruption, cable reconnects, or discontinuity in zone enforcement.
- Provide strong fault and event isolation between Admin Domains.
- Have visibility of all physical fabric resources. All switches, E\_Ports, and FRUs (including blade information) are visible.
- Continue to run existing third-party management applications. Prior and existing versions of third party management applications continue to work with admin and user IDs.

---

### ATTENTION

The Admin Domain administrator can define up to 254 ADs (AD1 – AD254) in the AD database; however, it is recommended that no more than 16 active Admin Domains run concurrently. More than 16 active Admin Domains might cause performance degradation and unpredictable system behavior.

---

## Requirements for Admin Domains

Implementing Admin Domains in a fabric has the following requirements:

- Admin Domains are not supported on the Brocade 8000. The Brocade 8000 can be in ADO only.
- The default zone mode setting must be set to No Access before you create Admin Domains (see [“Setting the default zoning mode for Admin Domains”](#) on page 344 for instructions).
- Virtual Fabrics must be disabled before you create Admin Domains (see [“Disabling Virtual Fabrics mode”](#) on page 224 for instructions).
- The fabric must be in the native operating mode. Admin Domains are not supported in interoperability mode.
- Gigabit Ethernet (GbE) ports cannot be members of an Admin Domain.
- Traffic Isolation is supported within Admin Domains, with some restrictions, as described in [“Admin Domain considerations for Traffic Isolation Zoning”](#) on page 279.
- If the fabric includes LSAN zones:
  - The LSAN zone names must not end with “\_ADn”.
  - The LSAN zone names must not be longer than 57 characters.

See [Chapter 21, “Using the FC-FC Routing Service,”](#) for information about the FC-FC Routing Service and LSAN zones.

## Admin Domain access levels

Admin Domains offer a hierarchy of administrative access. To manage Admin Domains, you must be a *physical fabric administrator*. A physical fabric administrator is a user with the admin role and access to all Admin Domains (AD0 through AD255). Only a physical fabric administrator can perform Admin Domain configuration and management.

Other administrative access is determined by your defined RBAC role and AD membership. Your role determines your access level and permission to perform an operation. Your AD membership determines the fabric resources that you can operate on.

[Table 73](#) lists each Admin Domain user type and describes its administrative access and capabilities.

**TABLE 73** AD user types

User type	Description
Physical fabric administrator	User account with admin role and with access to all Admin Domains (AD0 through AD255). Creates and manages all Admin Domains. Assigns other administrators or users to each Admin Domain. Only a physical fabric administrator can create other physical fabric administrators.
Administrative Domain users	Can be assigned to one or more Admin Domains. Manage the resources within their Admin Domains. If their role permits, can create user accounts and assign them to Admin Domains in their list. Cannot view other Admin Domain definitions. They can view only members of their own Admin Domains.

## User-defined Administrative Domains

AD1 through AD254 are user-defined Admin Domains. These user-defined Admin Domains can be created only by a physical fabric administrator (see [“Admin Domain access levels”](#) on page 338 for more information).

In [Figure 51](#) on page 336, AD1 and AD2 are user-defined Admin Domains.

## System-defined Administrative Domains

AD0 and AD255 are special, system-defined Admin Domains. AD0 and AD255 always exist and cannot be deleted or renamed. They are reserved for use in creation and management of Admin Domains.

### *ADO*

AD0 is a system-defined Admin Domain that contains all online devices, switch ports, and switches that are not assigned to any user-defined Admin Domain. AD0 also contains members that you explicitly added (similar to user-defined Admin Domains).

Unlike user-defined Admin Domains, AD0 has an implicit and an explicit membership list. User-defined Admin Domains have only explicit members.

- The *implicit membership list* contains all devices, switch ports, and switches that have not been assigned to any other Admin Domain.

Initially, the ADO implicit membership list contains all devices, switch ports, and switches in the fabric. When you explicitly create AD1 through AD254, the devices, switch ports, and switches used to create these user-defined Admin Domains disappear from the ADO implicit membership list.

- The *explicit membership list* contains all devices, switch ports, and switches that you explicitly add to ADO and can be used to force device and switch sharing between ADO and other Admin Domains.

ADO can be managed like any user-defined Admin Domain. The only difference between ADO and user-defined Admin Domains is the implicit membership list.

The implicit members of ADO change dynamically as the membership of other Admin Domains changes. The explicit members of ADO are not deleted unless you explicitly remove them.

For example, if you explicitly add DeviceA to ADO and it is not a member of any other Admin Domain, then DeviceA is both an implicit and an explicit member of ADO. If you add DeviceA to AD2, then DeviceA is deleted from the ADO implicit membership list, but is *not* deleted from the ADO explicit membership list. If you then remove DeviceA from AD2, DeviceA is added back to the ADO implicit membership list (assuming DeviceA is not in any other Admin Domain).

When a new device is added to the fabric, it automatically becomes an implicit member of ADO until it is explicitly added to an Admin Domain.

ADO is useful when you create Admin Domains because you can see which devices, switch ports, and switches are not yet assigned to any Admin Domains.

ADO owns the root zone database (legacy zone database).

## **AD255**

AD255 is used for Admin Domain management. You can use AD255 to get an unfiltered view of the fabric and to view the hierarchical zone databases of ADO through AD254. All Admin Domain management is done in the AD255 context.

AD255 does not have a zone database associated with it; you cannot use AD255 to perform any zoning management tasks (non-read operations such as creating or modifying zones).

[Figure 53](#) on page 340 shows the same fabric from [Figure 51](#) on page 336, but with ADO and AD255 shown. ADO contains the two devices that are not in any of the user-defined Admin Domains (AD1 and AD2). AD255 encompasses the entire physical fabric.

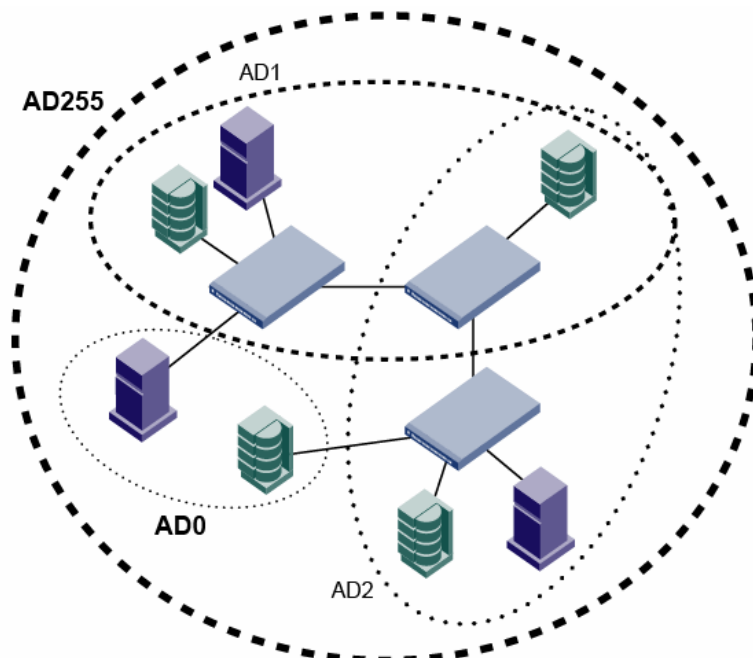

FIGURE 53 Fabric with AD0 and AD255

## Admin Domains and login

You are always logged in to an Admin Domain, and you can view and modify only the devices in that Admin Domain.

If you have access to more than one Admin Domain, one of them is designated as your *home Admin Domain*, the one you are automatically logged in to. If your home Admin Domain is deleted or deactivated, then by default you are logged in to the lowest numbered active Admin Domain in your Admin Domain List. The home Admin Domain, like the Admin Domain list, is a configurable property of a non-default user account. Here is some additional information about AD accounts:

- You can log in to only one Admin Domain at a time. You can later switch to a different Admin Domain (see [“Switching to a different Admin Domain context”](#) on page 358 for instructions).
- For default accounts such as admin and user, the home Admin Domain defaults to AD0 and cannot be changed.
- The Admin Domain list for the default admin account is 0–255, which gives this account automatic access to any Admin Domain as soon as the domain is created, and makes this account a physical fabric administrator.
- The Admin Domain list for the default user account is AD0 only.
- For user-defined accounts, the home Admin Domain also defaults to AD0 but an administrator can set the home Admin Domain to any Admin Domain to which the account has been given access.
- If you are in any Admin Domain context other than AD0, the Admin Domain number is included in the system prompt displayed during your session. The following are example prompts for when you are in the AD0, AD1, and AD255 contexts, respectively:

```
switch:admin>
switch:AD1:admin>
switch:AD255:admin>
```

## Admin Domain member types

You define an Admin Domain by identifying members of that domain. Admin Domain members can be devices, switch ports, or switches. Defining these member types is similar to defining a traditional zone member type. An Admin Domain does not require or have a new domain ID or management IP address linked to it.

### *Device members*

Device members are defined by the device World Wide Name (WWN) and have the following properties:

- A device member can be either a device port WWN or device node WWN.
- A device member grants view access to the device and zoning rights. View rights are also granted to the switch port to which the device is attached.
- A device member provides a pure virtual view. The cabling and switch port diagnostics and control are done by the physical fabric administrator.

Port control is provided only through switch port membership and is not provided for device members. When you create an Admin Domain, the end device members do not need to be online, even though their WWNs are used in the Admin Domain definition.

You can share device members across multiple Admin Domains. You can also zone shared devices differently in each Admin Domain. A device WWN member does not automatically grant usage of corresponding *domain,index* members in the zone configuration. If you specify a device WWN member in the Admin Domain member list, zone enforcement ignores zones with the corresponding port (the port to which the device is connected) member usage.

### *Switch port members*

Switch port members are defined by switch *domain,index* and have the following properties:

- A switch port member grants port control rights and zoning rights for that switch port.
- A switch port member grants view access and zoning rights to the device connected to that switch port.
- A switch port member allows you to share *domain,index* members across multiple Admin Domains. In each Admin Domain, you can also zone shared devices differently.
- A switch port member implicitly includes all devices connected to the specified *domain,index* members in the Admin Domain membership.
- A switch port member allows you to specify a range of indices as Admin Domain members. For example: `<D, [0-15]>`. The index range arguments are expanded and stored in the Admin Domain member list.

If a device is a member of an Admin Domain, the switch port to which the device is connected becomes an indirect member of that Admin Domain and the *domain,index* is removed from the ADO implicit membership list.

---

#### NOTE

If the switch domain ID changes, the *domain,index* members are invalid (they are not automatically changed). You must then reconfigure the Admin Domain with the current *domain,index* members.

---

### *Switch members*

Switch members are defined by the switch WWN or domain ID, and have the following properties:

- A switch member grants administrative control to the switch.
- A switch member grants port control for all ports in that switch.
- A switch member allows switch administrative operations such as disabling and enabling a switch, rebooting, and firmware downloads.
- A switch member does not provide zoning rights for the switch ports or devices.

To allow devices to be zoned within Admin Domains, you must specify the port members using *domain,index* or device WWN members.

E\_Ports (including VE\_Ports, EX\_Ports, and VEX\_Ports) are implicitly shared across all Admin Domains. An administrator can perform port control operations only if the *domain,index* of the E\_Port is part of the Admin Domain.

---

#### **NOTE**

Only the WWN of the switch is saved in the Admin Domain. If you change the domain ID of the switch, the Admin Domain ownership of the switch is not changed.

---

## **Admin Domains and switch WWN**

Admin Domains are treated as fabrics. Because switches cannot belong to more than one fabric, switch WWNs are converted so that they appear as unique entities in different Admin Domains (fabrics). This WWN conversion is done only in the AD1 through AD254 context. ADO and AD255 use unconverted switch WWNs.

The switch WWN has the following format:

10:00:nn:nn:nn:nn:nn:nn

In an Admin Domain context, the switch WWN is converted from NAA=1 to NAA=5 format, with the Admin Domain number added, using the following syntax:

5n:nn:nn:nn:nn:nn:n9:xx

where xx is the Admin Domain number.

For example, if the switch WWN is:

10:00:00:60:69:e4:24:e0

then the converted WWN for that switch in AD1 would be:

50:06:06:9e:42:4e:09:01

[Figure 54](#) shows an unfiltered view of a fabric with two switches, three devices, and two Admin Domains. The devices are labeled with device WWNs and the switches are labeled with domain ID and switch WWNs.

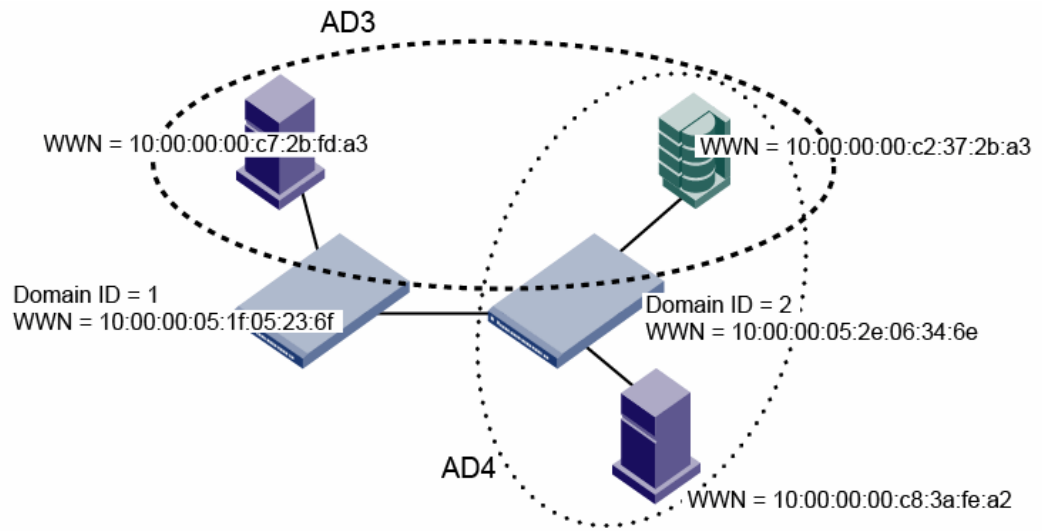

FIGURE 54 Fabric showing switch and device WWNs

Figure 55 shows the filtered view of the fabric as seen from AD3 and AD4. The switch WWNs are converted to the NAA=5 syntax; the device WWNs and domain IDs remain the same.

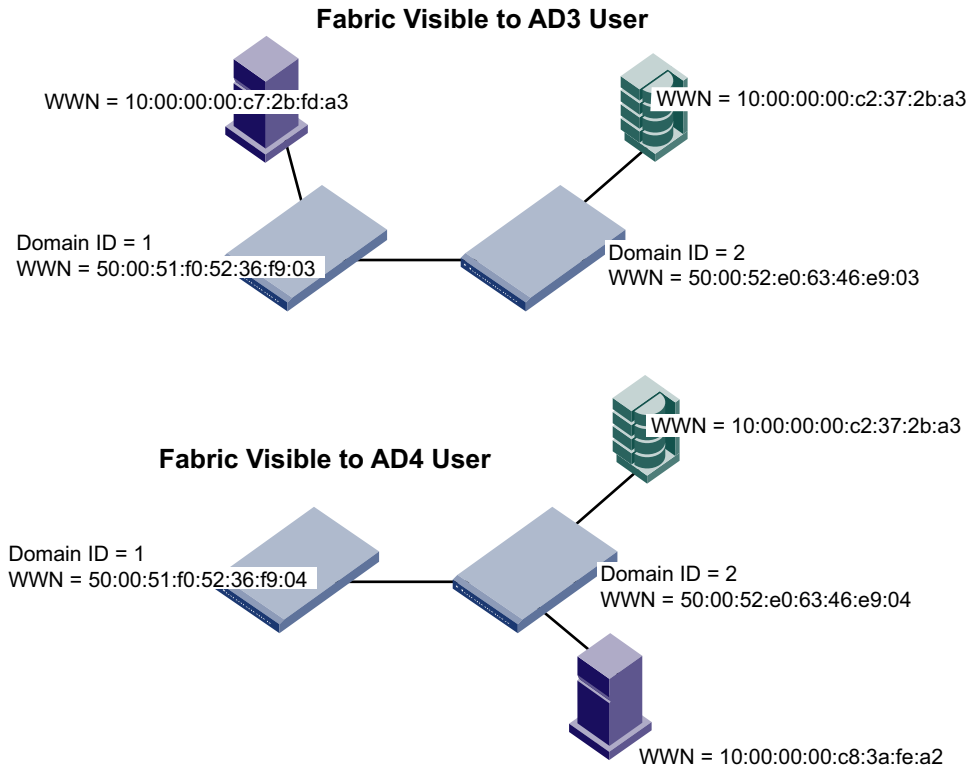

FIGURE 55 Filtered fabric views showing converted switch WWNs

## Admin Domain compatibility, availability, and merging

Admin Domains maintain continuity of service for Fabric OS features and operate in mixed-release Fabric OS environments. High availability is supported with some backward compatibility.

When an E\_Port comes online, the adjacent switches merge their AD databases. The receiving switch accepts an AD database from the neighboring switch only if the local AD database is empty or if the new AD database exactly matches both the defined and effective configurations of the local AD database. If the AD database merge fails, the E\_Port is segmented with an “AD conflict” error code.

## Admin Domain management for physical fabric administrators

This section is for physical fabric administrators who are managing Admin Domains. You must be a physical fabric administrator to perform the tasks in this section.

You use the **ad** command to perform most of the tasks in this section. This command follows a batched-transaction model, which means that changes to the Admin Domain configuration occur in the transaction buffer.

An Admin Domain configuration can exist in several places:

- **Effective configuration** — The Admin Domain configuration that is currently in effect.
- **Defined configuration** — The Admin Domain configuration that is saved in flash memory. There might be differences between the effective configuration and the defined configuration.
- **Transaction buffer** — The Admin Domain configuration that is in the current transaction buffer and has not yet been saved or canceled.

How you end the transaction determines the disposition of the Admin Domain configuration in the transaction buffer. The following commands end the Admin Domain transaction:

- |                        |   |
|------------------------|---|
| <b>ad --save</b>       | Saves the changes in the transaction buffer to the defined configuration in persistent storage and propagates the defined configuration to all switches in the fabric. Note that for <b>delete</b> and <b>clear</b> operations, if one or more of the deleted Admin Domains are in the effective configuration, you cannot use <b>--save</b> , but must use <b>--apply</b> instead. |
| <b>ad --apply</b>      | Saves the changes to the defined configuration in persistent storage and enforces the defined configuration on all switches in the fabric, replacing the effective configuration.   |
| <b>ad --transabort</b> | Aborts the transaction and clears the transaction buffer. The effective and defined configurations remain unchanged.  |

You can enter the **ad --transshow** command at any time to display the ID of the current Admin Domain transaction.

## Setting the default zoning mode for Admin Domains

To begin implementing an Admin Domain structure within your SAN, you must first set the default zoning mode to No Access. You must be in ADO to change the default zoning mode.



1. Log in to the switch with the appropriate RBAC role.
2. Ensure you are in the ADO context by entering the `ad --show` command to determine the current Admin Domain.  
If necessary, switch to the ADO context by entering the `ad --select 0` command.
3. Set the default zoning mode to No Access, as described in [“Setting the default zoning mode”](#) on page 252.

## Creating an Admin Domain

To create an Admin Domain, you must specify an Admin Domain name, number, or both:

- If you create an Admin Domain using only a number, the Admin Domain name is automatically assigned to be “AD $n$ ”, where  $n$  is the number you specified.  
For example, if you specify AD number = 4, then AD name is set to “AD4”.
- If you create an Admin Domain using only a name, the Admin Domain number is automatically assigned and is the lowest available AD number, except if you specify a name in the format “AD $n$ ”, in which case the Admin Domain number is assigned to be  $n$ .  
For example, if you specify AD name = “blueAD” and the lowest available AD number is 5, then AD name is “blueAD” and AD number is 5.

If you specify AD name = “AD15” and the lowest available AD number is 6, then AD name is “AD15” and AD number is 15. Because the specified name is in the format “AD $n$ ”, the AD number is assigned to be  $n$  and *not* the lowest available AD number.

The Admin Domain name cannot exceed 63 characters and can contain alphabetic and numeric characters. The only special character allowed is an underscore ( `_` ).

When you create an Admin Domain, you must specify at least one member (switch, switch port, or device). You cannot create an empty Admin Domain. For more information about these member types, see [“Admin Domain member types”](#) on page 341.

A newly created Admin Domain has no zoning defined and the default access mode is No Access. This means the devices in the Admin Domain cannot communicate with each other. You must set up zones in the newly created Admin Domain to allow devices to access each other, even if the devices were already zoned together prior to your moving them to the Admin Domain. See [“Admin Domains, zones, and zone databases”](#) on page 360 for additional information about how zones work with Admin Domains.

You create Admin Domains in the transaction buffer. You can either save the newly created Admin Domain to a defined configuration or make it the effective Admin Domain configuration directly.

The following procedure describes the steps for creating Admin Domains.

1. Log in to the switch as the physical fabric administrator.
2. Disable Virtual Fabrics, if necessary, as described in [“Disabling Virtual Fabrics mode”](#) on page 224. Admin Domains and Virtual Fabrics cannot co-exist.
3. Set the default zone mode to No Access, if you have not already done so. See [“Setting the default zoning mode”](#) on page 252 for instructions.
4. Switch to the AD255 context, if you are not already in that context:

```
ad --select 255
```

5. Enter the `ad --create` command using the `-d` option to specify device and switch port members and the `-s` option to specify switch members:

```
ad --create ad_id -d "dev_list" -s "switch_list"
```

6. Enter the appropriate command based on whether you want to save or activate the Admin Domain definition:
  - To save the Admin Domain definition, enter `ad --save`.
  - To save the Admin Domain definition and directly apply the definition to the fabric, enter `ad --apply`.
7. Set up zones in the newly created Admin Domain. See [Chapter 11, “Administering Advanced Zoning,”](#) for instructions.

### Example 1

The following example creates Admin Domain AD1, consisting of two switches, which are designated by domain ID and switch WWN.

```
switch:AD255:admin> ad --create AD1 -s "97; 10:00:00:60:69:80:59:13"
```

### Example 2

The following example creates Admin Domain “blue\_ad,” consisting of two switch ports (designated by *domain,index*), one device (designated by device WWN), and two switches (designated by domain ID and switch WWN).

```
switch:AD255:admin> ad --create blue_ad -d "100,5; 1,3; 21:00:00:e0:8b:05:4d:05; -s "97; 10:00:00:60:69:80:59:13"
```

## User assignments to Admin Domains

After you create an Admin Domain, you can specify one or more user accounts as the valid accounts who can use that Admin Domain. User accounts have the following characteristics with regard to Admin Domains:

- A user account can only have a single role.  
You can choose roles from one of the seven types of roles, either the existing user and administrator role or one of the other RBAC roles.
- You can configure a user account to have access to the physical fabric through AD255 and to a list of Admin Domains (AD0–AD254).
- You can configure a user account to have access to only a subset of your own Admin Domain list. Only a physical fabric administrator can create another physical fabric administrator user account.
- Users capable of using multiple Admin Domains can designate one of these Admin Domains as the home Admin Domain, which is the default Admin Domain context after login.
- If you do not specify one, the home Admin Domain is the lowest valid Admin Domain in the numerically-sorted AD list.
- Users can log in to their Admin Domains and create their own Admin Domain-specific zones and zone configurations.

### *Creating a new user account for managing Admin Domains*

1. Connect to the switch and log in as admin.
2. Enter the **userConfig --add** command using the **-r** option to set the role, the **-a** option to provide access to Admin Domains, and the **-h** option to specify the home Admin Domain.

```
userconfig --add username -r role -h home_AD -a "AD_list"
```

#### **Example 1**

The following example creates new user account ad1admin with an admin role and assigns one Admin Domain, blue\_ad1, to it. This example also assigns blue\_ad1 as the user's home Admin Domain.

```
switch:admin> userconfig --add ad1admin -r admin -h blue_ad1 -a "blue_ad1"
```

#### **Example 2**

The following example creates new user account ad2admin with an admin role, access to Admin Domains 1 and 2, and home Admin Domain set to 2.

```
switch:admin> userconfig --add ad2admin -r admin -h 2 -a "1,2"
```

### *Assigning Admin Domains to an existing user account*

1. Connect to the switch and log in as admin.
2. Enter the **userConfig --addad** command using the **-a** option to provide access to Admin Domains and the **-h** option to specify the home Admin Domain.

```
userconfig --addad username -h home_AD -a "AD_list"
```

#### **Example**

The following example assigns Admin Domain green\_ad2 to the existing user account ad1admin.

```
switch:admin> userconfig --addad ad1admin -a "green_ad2"
```

### *Creating a physical fabric administrator user account*

1. Connect to the switch and log in as admin.
2. Enter the **userConfig --add** command using the **-r** option to set the role to admin and the **-a** option to provide access to Admin Domains 0 through 255.

```
userconfig --add username -r admin -h home_AD -a "0-255"
```

#### **Example**

The following example creates new user account pfa\_admin1 with an admin role, access to all Admin Domains (AD0 through AD255), and home Admin Domain set to 255. This user account is now a physical fabric administrator.

```
switch:admin> userconfig --add pfa_admin1 -r admin -h 255 -a "0-255"
```

## Removing an Admin Domain from a user account

When you remove an Admin Domain from an account, all of the currently active sessions for that account are logged out.

1. Connect to the switch and log in using an account assigned to the admin role.
2. Enter the `userconfig --deletead` command:

```
userconfig --deletead username [-h admindomain_ID] [-a admindomain_ID_list]
```

If the `-h` argument is not specified, the home Admin Domain either remains as it was or becomes the lowest Admin Domain ID in the remaining list.

### Example

```
switch:admin> userconfig --deletead adm1 -a "green_ad2"
```

```
Broadcast message from root (pts/0) Wed Jan 27 20:57:14 2010...
```

```
Security Policy, Password or Account Attribute Change: adm1 will be logged out  
Ads for account adm1 has been successfully deleted.
```

## Activating an Admin Domain

An Admin Domain can be in either an active or inactive state. When you create an Admin Domain, it is automatically in the active state.

1. Connect to the switch and log in as admin.
2. Switch to the AD255 context, if you are not already in that context.

```
ad --select 255
```

3. Enter the `ad --activate` option. The activate option prompts for confirmation.

```
ad --activate ad_id
```

By default, after the Admin Domain is activated, the devices specified under that AD are not able to see each other until they are zoned together.

4. Enter the appropriate command based on whether you want to save or activate the Admin Domain definition:
  - To save the Admin Domain definition, enter `ad --save`.
  - To save the Admin Domain definition and directly apply the definition to the fabric, enter `ad --apply`.

### Example

The following example activates Admin Domain AD\_B5.

```
switch:AD255:admin> ad --activate AD_B5  
You are about to activate a new admin domain.  
Do you want to activate 'AD_B5' admin domain (yes, y, no, n): [no]: y  
switch:AD255:admin>
```

## Deactivating an Admin Domain

If you deactivate an Admin Domain, the members assigned to the Admin Domain can no longer access their hosts or storage unless those members are part of another Admin Domain.

You cannot log in to an Admin Domain that has been deactivated. You must activate an Admin Domain before you can log in to it.

1. Connect to the switch and log in as admin.
2. Disable the zone configuration under the Admin Domain you want to deactivate.

```
cfgdisable
```

3. Switch to the AD255 context, if you are not already in that context.

```
ad --select 255
```

4. Enter the **ad --deactivate** command.

```
ad --deactivate ad_id
```

You are then prompted for confirmation.

5. Enter the appropriate command based on whether you want to save or activate the Admin Domain definition:

- To save the Admin Domain definition, enter **ad --save**.
- To save the Admin Domain definition and directly apply the definition to the fabric, enter **ad --apply**.

All active user sessions associated with the Admin Domain are terminated. The deactivate option does not disable ports.

### Example

The following example deactivates Admin Domain AD\_B4.

```
switch:AD255:admin> ad --deactivate AD_B4
You are about to deactivate an AD.
This operation will fail if an effective zone configuration exists in the AD
Do you want to deactivate 'AD_B5' admin domain (yes, y, no, n): [no] y
switch:AD255:admin>
```

## Adding members to an existing Admin Domain

1. Connect to the switch and log in as admin.
2. Switch to the AD255 context, if you are not already in that context.

```
ad --select 255
```

3. Enter the **ad --add** command using the **-d** option to specify device and switch port members and the **-s** option to specify switch members:

```
ad --add ad_id -d "dev_list" -s "switch_list"
```

where *ad\_id* is the Admin Domain name or number, *dev\_list* is a list of device WWNs or *domain,index* members, and *switch\_list* is a list of switch WWNs or domain IDs.

4. Enter the appropriate command based on whether you want to save or activate the Admin Domain definition:
  - To save the Admin Domain definition, enter **ad --save**.
  - To save the Admin Domain definition and directly apply the definition to the fabric, enter **ad --apply**.

### Example

The following example adds two switch ports, designated by *domain,index*, to AD1.

```
switch:AD255:admin> ad --add AD1 -d "100,5; 4,1"
```

## Removing members from an Admin Domain

If you remove the last member of an Admin Domain, that Admin Domain is automatically deleted.

1. Connect to the switch and log in as admin.
2. Switch to the AD255 context, if you are not already in that context.

```
ad --select 255
```

3. Enter the **ad --remove** command using the **-d** option to specify device and switch port members and the **-s** option to specify switch members:

```
ad --remove ad_id -d "dev_list" -s "switch_list"
```

Removing the last member element of an Admin Domain deletes the Admin Domain.

4. Enter the appropriate command based on whether you want to save or activate the Admin Domain definition:
  - To save the Admin Domain definition, enter **ad --save**.
  - To save the Admin Domain definition and directly apply the definition to the fabric, enter **ad --apply**.

### Example 1

The following example removes port 5 of domain 100 and port 3 of domain 1 from AD1.

```
switch:AD255:admin> ad --remove 1 -d "100,5; 1,3"
```

### Example 2

The following example removes switch 100 from the membership list of AD4.

```
switch:AD255:admin> ad --remove 4 -s "100"
```

## Renaming an Admin Domain

Use this procedure if you want to change the name of an Admin Domain. You can also change auto-assigned names (AD*n*).

The rename operation does not take effect if the Admin Domain you want to rename is part of the effective configuration and thus enforced.

1. Connect to the switch and log in as admin.
2. Switch to the AD255 context, if you are not already in that context.

```
ad --select 255
```

3. Enter the **ad --rename** command with the present name and the new name.

```
ad --rename present_name new_name
```

4. Enter the appropriate command based on whether you want to save or activate the Admin Domain definition:

- To save the Admin Domain definition, enter **ad --save**.
- To save the Admin Domain definition and directly apply the definition to the fabric, enter **ad --apply**.

The Admin Domain numbers remain unchanged after the operation.

#### Example

The following example changes the name of Admin Domain Eng\_AD to Eng\_AD2.

```
switch:AD255:admin> ad --rename Eng_AD Eng_AD2
```

## Deleting an Admin Domain

When you delete an Admin Domain, its devices no longer have access to the members of the zones with which it was associated.

1. Connect to the switch and log in as admin.
2. Switch to the Admin Domain that you want to delete.

```
ad --select ad_id
```

3. Enter the appropriate command to clear the zone database under the Admin Domain you want to delete.

- To remove the effective configuration, enter **cfgdisable**.
- To remove the defined configuration, enter **cfgclear**.
- To save the changes to nonvolatile memory, enter **cfgsave**.

4. Switch to the AD255 context.

```
ad --select 255
```

5. Enter the **ad --delete** command.

```
ad --delete ad_id
```

The **ad --delete** command prompts you for confirmation before triggering the deletion. The command succeeds whether the Admin Domain is in an activated or deactivated state.

6. Enter the **ad --apply** command to save the Admin Domain definition and directly apply the definition to the fabric.

#### Example

The following example deletes Admin Domain AD\_B3.

```
switch:AD255:admin> ad --delete AD_B3
You are about to delete an AD.
This operation will fail if zone configuration exists in the AD
Do you want to delete 'AD_B3' admin domain (yes, y, no, n): [no] y
switch:AD255:admin>
```

## Deleting all user-defined Admin Domains

When you clear the Admin Domain configuration, all user-defined Admin Domains are deleted, the explicit membership list of ADO is cleared, and all fabric resources (switches, ports, and devices) are returned to the implicit membership list of ADO.

You cannot clear the Admin Domain configuration if zone configurations exist in any of the user-defined Admin Domains.

If you want to remove all Admin Domains while retaining device connectivity (for example, if you want to enable Virtual Fabrics), use the procedure described in [“Deleting all user-defined Admin Domains non-disruptively.”](#)

1. Clear all individual AD zone databases, in separate transactions, before proceeding with this operation. See [“Clearing all zone configurations”](#) on page 258 for instructions.
2. Connect to the switch and log in as admin.
3. Switch to the AD255 context, if you are not already in that context.

```
ad --select 255
```

4. Enter the **ad --clear** command.

This option prompts you for confirmation before triggering the deletion of all Admin Domains.

5. Enter the **ad --apply** command to save the Admin Domain definition and directly apply the definitions to the fabric.

### Example

```
switch:AD255:admin> ad --clear
You are about to delete all ADs definitions.
This operations will fail if zone configurations exists in AD1-AD254
Do you want to clear all admin domains (yes, y, no, n): [no] y
switch:AD255:admin>
```

## Deleting all user-defined Admin Domains non-disruptively

To disable Admin Domains non-disruptively, you must do the following before you clear the user-defined ADs:

- Create and activate zone configurations in ADO that are equivalent to the zone configurations in each of the user-defined ADs
- Define all of the members that are currently in user-defined ADs in ADO.

This will ensure that the devices are still able to communicate even when they are removed from the user-defined ADs.

You can use this procedure to remove all Admin Domains before enabling Virtual Fabrics.

1. Connect to the switch and log in as admin.
2. Enter the **cfgshow** command in the AD255 context to display the zone configurations for all Admin Domains.

```
ad --exec 255 "cfgshow"
```

3. Enter the **zone --copy** command to copy the zones from all user-defined Admin Domains to ADO.

```
zone --copy source_AD.source_name dest_name
```



where:

*source\_AD* Name of the user-defined AD from which you are copying the zone.

*source\_name* Name of the zone to be copied.

*dest\_name* Name to give the zone after it is copied to ADO.

4. Copy the newly added zones in ADO to the zone configuration.

```
cfgadd "cfgName", "member[;member]"
```

5. Enable the configuration to complete the transaction.

```
cfgenable cfgName
```

6. Switch to the AD255 context.

```
ad --select 255
```

7. Explicitly add devices that are present in the user-defined ADs to ADO.

```
ad --add AD0 -d "dev_list"
```

8. Enter the **ad --apply** command to save the Admin Domain definition and directly apply the definitions to the fabric.

```
ad --apply
```

At this point, all of the devices in the user-defined ADs are also defined and zoned in ADO.

9. Clear the user-defined ADs.

```
ad --clear -f
```

10. Enter the **ad --apply** command to save the Admin Domain definition and directly apply the definitions to the fabric.

```
ad --apply
```

All user-defined Admin Domains have now been removed, but all device communication that was allowed with the original Admin Domain configuration is still permitted in the context of ADO.

### Example

The following example assumes the configuration shown in [Figure 56](#) on page 354:

- Three Admin Domains: ADO, plus two user-defined Admin Domains (AD1 and AD2)
- ADO has two devices, WWN1 and WWN2, in the ADO\_RedZone
- AD1 has two devices, WWN2 and WWN3, in the AD1\_BlueZone
- AD2 has two devices, WWN3 and WWN4, in the AD2\_GreenZone
- The device WWN2 is in both ADO and AD1.

At the conclusion of the procedure, all devices and zones are moved to ADO, and the user-defined Admin Domains are deleted, as shown in [Figure 57](#).

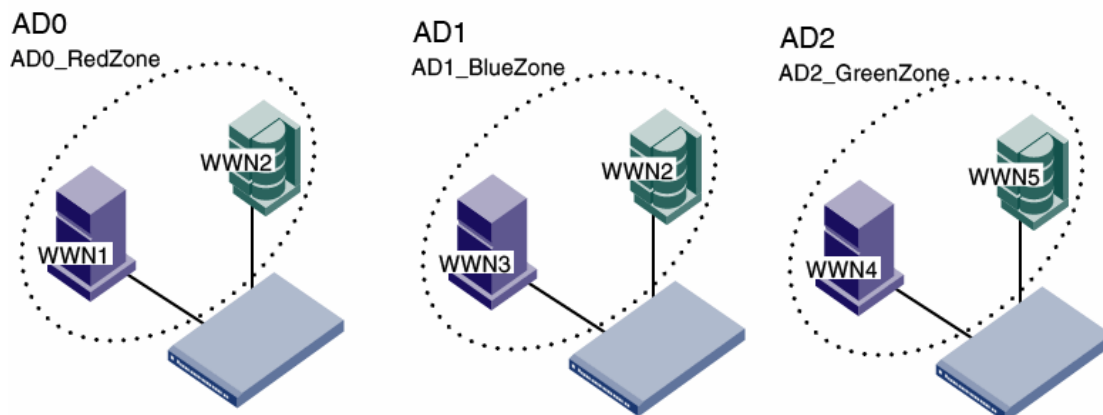

FIGURE 56 AD0 and two user-defined Admin Domains, AD1 and AD2

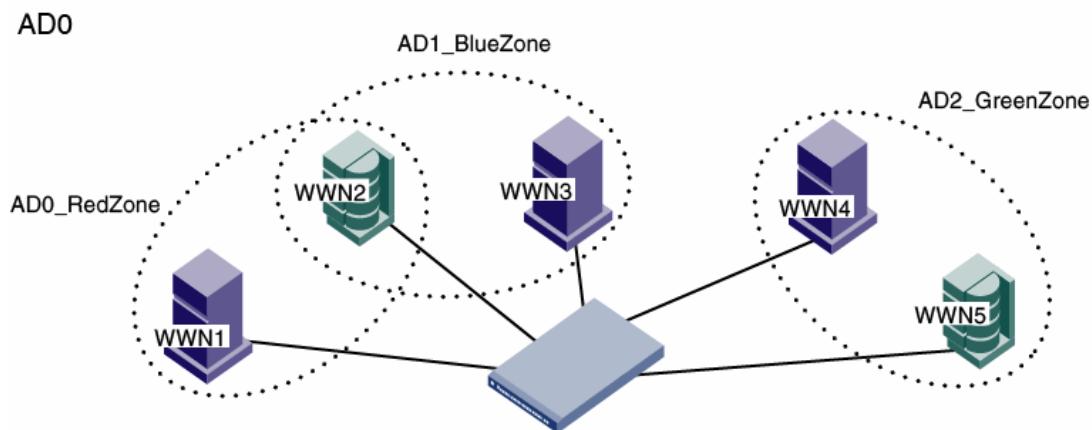

FIGURE 57 AD0 with three zones

```
sw0:admin> ad --exec 255 "cfgshow"

Zone CFG Info for AD_ID: 0 (AD Name: AD0, State: Active) :

Defined configuration:
cfg: AD0_cfg AD0_RedZone
zone: AD0_RedZone
      10:00:00:00:01:00:00:00; 10:00:00:00:02:00:00:00

Effective configuration:
cfg: AD0_cfg
zone: AD0_RedZone
      10:00:00:00:01:00:00:00
      10:00:00:00:02:00:00:00

Zone CFG Info for AD_ID: 1 (AD Name: AD1, State: Active) :

Defined configuration:
cfg: AD1_cfg AD1_BlueZone
zone: AD1_BlueZone
      10:00:00:00:02:00:00:00; 10:00:00:00:03:00:00:00
```

```

Effective configuration:
  cfg:  AD1_cfg
  zone:  AD1_BlueZone
          10:00:00:00:02:00:00:00
          10:00:00:00:03:00:00:00

Zone CFG Info for AD_ID: 2   (AD Name: AD2, State: Active) :

Defined configuration:
  cfg:  AD2_cfg AD2_GreenZone
  zone:  AD2_GreenZone
          10:00:00:00:04:00:00:00; 10:00:00:00:05:00:00:00

Effective configuration:
  cfg:  AD2_cfg
  zone:  AD2_GreenZone
          10:00:00:00:04:00:00:00
          10:00:00:00:05:00:00:00

sw0:admin> zone --copy AD1.AD1_BlueZone AD0_BlueZone
sw0:admin> zone --copy AD2.AD2_GreenZone AD0_GreenZone
sw0:admin> cfgadd "AD0_cfg", "AD0_BlueZone; AD0_GreenZone"
sw0:admin> cfgenable AD0_cfg
You are about to enable a new zoning configuration.
This action will replace the old zoning configuration with the
current configuration selected. If the update includes changes
to one or more traffic isolation zones, the update may result in
localized disruption to traffic on ports associated with
the traffic isolation zone changes
Do you want to enable 'AD0_cfg' configuration (yes, y, no, n): [no] y
zone config "AD0_cfg" is in effect
Updating flash ...

sw0:admin> ad --select 255
sw0:AD255:admin> ad --add AD0 -d "10:00:00:00:03:00:00:00;
10:00:00:00:04:00:00:00; 10:00:00:00:05:00:00:00"
sw0:AD255:admin> ad --apply
You are about to enforce the saved AD configuration.
This action will trigger AD apply to all switches in the fabric
Do you want to apply all admin domains (yes, y, no, n): [no] y

sw0:AD255:admin> ad --clear -f
You are about to delete all ADs definitions and zone databases under them.
This could involve multiple independent zone transactions and
no auto recovery will be done in case of failure in the middle.
Do you want to clear all admin domains (yes, y, no, n): [no] y

sw0:AD255:admin> ad --apply
You are about to enforce the saved AD configuration.
This action will trigger AD apply to all switches in the fabric
Do you want to apply all admin domains (yes, y, no, n): [no] y

```

## Validating an Admin Domain member list

You can validate the device and switch member list. You can list non-existing or offline Admin Domain members. You can also identify misconfigurations of the Admin Domain.

The Admin Domain validation process is not applicable for ADO, because ADO implicitly contains all unassigned online switches and their devices.

1. Connect to the switch and log in as admin.
2. Switch to the AD255 context, if you are not already in that context.

```
ad --select 255
```

3. Enter the `ad --validate` command.

```
ad --validate ad_id -m mode
```

If you do not specify any parameters, the entire AD database (transaction buffer, defined configuration, and effective configuration) is displayed.

If you do not specify an Admin Domain, information about all existing Admin Domains is displayed.

The `-m mode` option can be used as follows:

- 0 to display the Admin Domain configuration in the current transaction buffer.
- 1 to display the Admin Domain configuration stored in the persistent memory (defined configuration).
- 2 to display the currently enforced Admin Domain configuration (effective configuration).

### Example

The following example validates the member list of Admin Domain 10 in the current transaction buffer.

```
switch:AD255:admin> ad --validate 10 -m 0
Current AD Number: 255  AD Name: AD255

Transaction buffer configuration:
-----
AD Number:    2    AD Name: ad2    State: Active
      Switch port members:          1,1; 1,3; 2,5+; 3,6;
-----
* - Member does not exist
+ - Member is AD Unaware
```

## SAN management with Admin Domains

This section is for both users and administrators and describes how Admin Domains affect commands and other Fabric OS features. If you are a physical fabric administrator and you want to create, modify, or otherwise manage Admin Domains, see [“Admin Domain management for physical fabric administrators”](#) on page 344.

The Admin Domain looks like a virtual switch or fabric to a user. However, based on the user role and type (User\_ID), users are presented with only their relevant AD-based views (see [Figure 51](#) on page 336 and [Figure 52](#) on page 336). Any devices and switch ports that are not defined as part of the Admin Domain are not shown and are not available to that AD user.

Each Admin Domain can also have its own zone configurations (defined and effective) with zones and aliases under them.

## CLI commands in an AD context

The CLI command input arguments are validated against the AD member list; they do not work with input arguments that specify resources that are not members of the current Admin Domain. All commands present filtered output, showing only the members of the current Admin Domain.

For example, **switchShow** displays details for the list of AD members present in that switch. Note the following about the **switchShow** output:

- Because all E\_Ports and EX\_Ports are shared across all Admin Domains, they are shown under all Admin Domains.
- Other ports are displayed without any attribute details (with an explanation that they are not part of the current Admin Domain).

A port or device appears in CLI command output or other management tool outputs if any one of the conditions listed in [Table 74](#) is met.

**TABLE 74** Ports and devices in CLI output

For	Condition
<i>domain,index</i>	<ul style="list-style-type: none"> <li>• The port is specified in the <i>domain,index</i> member list of the Admin Domain.</li> <li>• One or more WWNs specified in the AD member list is attached to the <i>domain,index</i>.</li> </ul>
Device WWN	<ul style="list-style-type: none"> <li>• The device WWN is specified in the AD WWN member list.</li> <li>• The device WWN is attached to one of the <i>domain,index</i> specified in the AD member list.</li> </ul>

RASLog and SYSlog output is not filtered based on AD membership.

See the *Fabric OS Command Reference* for more detailed information about command syntax and usage and to understand how existing commands behave in an AD context.

## Executing a command in a different AD context

You can execute a command in an Admin Domain that is different from your current AD context. The Admin Domain must be one that you can access. This option creates a new shell with the current *user\_id*, switches to the specified Admin Domain, performs the specified command, and exits the shell.

1. Connect to the switch and log in.
2. Enter the **ad --exec** command, specifying the Admin Domain and the command you want to execute.

```
ad --exec ad_id "command"
```

### Example

The following example executes the **switchShow** command in the AD7 context.

```
switch:AD255:admin> ad --exec 7 "switchshow"
```

## Displaying an Admin Domain configuration

You can display the membership information and zone database information of a specified Admin Domain. Note the following differences in the information displayed based on the Admin Domain:

- AD255: if you do not specify the AD\_name or number, all information about all existing Admin Domains is displayed.
- ADO-AD254 contexts: the membership of the current Admin Domain is displayed.
- ADO: the device and switch list members are categorized into implicit and explicit member lists.

1. Connect to the switch and log in as any user type.
2. Enter the **ad --show** command.

```
ad --show
```

If you are in the ADO context, you can use the **-i** option to display the implicit membership list of ADO; otherwise, only the explicit membership list is displayed.

```
ad --show -i
```

If you are in the AD255 context, all Admin Domain configuration from the transaction buffer, defined configuration, and effective configuration is displayed, unless you use the **-m** option:

```
ad --show ad_id -m mode
```

where *ad\_id* is the Admin Domain for which you want to display information and *mode* is one of the following:

- 0 to display the Admin Domain configuration in the current transaction buffer.
- 1 to display the Admin Domain configuration stored in the persistent memory (defined configuration).
- 2 to display the currently enforced Admin Domain configuration (effective configuration).

### Example

The following example displays membership information about AD1.

```
switch:AD1:admin> ad --show
Current AD Number: 1 AD Name: TheSwitches

Effective configuration:
-----

AD Number: 1 AD Name:   TheSwitches      State: Active

Switch WWN members:      50:06:06:99:00:2a:e9:01;
                          50:00:51:e0:23:36:f9:01;
                          50:06:06:98:05:be:99:01;
```

## Switching to a different Admin Domain context

You can switch between different Admin Domain contexts. This option creates a new shell with a new Admin Domain context. If the corresponding Admin Domain is not activated, the operation fails.

1. Connect to the switch and log in as any user type.
2. Enter the **ad --select** command and the Admin Domain you want to switch to.
3. Leave the new Admin Domain context by exiting from the shell.

#### logout

You cannot switch to another Admin Domain context from within the shell created by **ad --select**. You must first exit the shell, and then issue the **ad --select** command again.

#### Example

The following example switches to the AD12 context and back. Note that the prompt changes to display the Admin Domain.

```
switch:admin> ad --select 12
switch:AD12:admin> logout
switch:admin>
```

## Admin Domain interactions with other Fabric OS features

The administrative domain feature provides interaction with other Fabric OS features and across third-party applications. You can manage Admin Domains with Web Tools as well as the CLI. If the current Admin Domain owns the switch, you can perform Fabric Watch operations.

Admin Domain interactions do not extend to user session tunneling across switches. A user logged into a switch can control only the local switch ports as specified in the Admin Domain.

When the fabric is in secure mode, the following applies:

- There is no support for ACL configuration under each Administrative Domain.
- ACL configuration commands are allowed only in ADO and AD255. None of the policy configurations are validated with AD membership.

[Table 75](#) lists some of the Fabric OS features and considerations that apply when using Admin Domains.

**TABLE 75 Admin Domain interaction with Fabric OS features**

Fabric OS feature	Admin Domain interaction
ACLs	If no user-defined Admin Domains exist, you can run ACL configuration commands in only ADO and AD255. If any user-defined Admin Domains exist, you can run ACL configuration commands only in AD255. You <i>cannot</i> use ACL configuration commands or validate ACL policy configurations against AD membership under each Admin Domain.
Advanced Performance Monitoring (APM)	All APM-related filter setup and statistics viewing is allowed only if the local switch is part of the current Admin Domain.
Fabric Watch	Fabric Watch configuration operations are allowed only if the local switch is part of the current Admin Domain.

TABLE 75 Admin Domain interaction with Fabric OS features (Continued)

Fabric OS feature	Admin Domain interaction
FC-FC Routing Service	<p>You can create LSAN zones as a physical fabric administrator or as an individual AD administrator. The LSAN zone can be part of the root zone database or the AD zone database.</p> <p>FCR collects the LSAN zones from all ADs. If both edge fabrics have matching LSAN zones and both devices are online, FCR triggers a device import.</p> <p>LSAN zone enforcement in the local fabric occurs only if the AD member list contains both of the devices (local and imported device) specified in the LSAN zone.</p> <p>To support legacy applications, WWNs are reported based on the AD context using NAA=5. As a result, you cannot use the NAA=5 field alone in the WWN to detect an FC router.</p>
FDMI	FDMI operations are allowed only in ADO and AD255.
FICON	<p>Admin Domains support FICON. However, you must perform additional steps because FICON management (CUP) requires additional physical control of the ports. You must set up the switch as a physical member of the FICON AD.</p> <p>Device Connection Control (DCC) and Switch Connection Control (SCC) policies are supported only in ADO and AD255, because ACL configurations are supported only in ADO and AD255.</p>
iSCSI	iSCSI operations are supported only in ADO.
Management applications	<p>Management interfaces that access the fabric without a user's credentials continue to get the physical fabric view. Examples include SNMPV1, Web Tools, http access, unzoned management server query, FAL in-band CT requests from FAL Proxy to FAL Target, and FC-CT based management applications (such as Tivoli).</p> <p>Access from applications or hosts using Management Server calls can be controlled using the Management Server ACL support provided by the <b>msConfigure</b> command. Note that this is a switch-specific setting and not a fabric-wide setting.</p>
Port-Swapping and PID formats	<p>Admin Domain port members are specified in <i>domain,index</i> format. Based on the PID format, a <i>domain,index</i> member indicates a slot and port in the switch. The <i>domain,index</i> member is effectively a member of that AD.</p> <p>Port swapping has no effect on AD support as port swapping swaps only the area numbers of two ports and Admin Domains are specified using <i>domain,index</i> members. For detailed information about configuring the PID format, see <a href="#">Chapter 3, "Performing Advanced Configuration Tasks"</a>.</p>
RSCN	Admin Domains do not introduce any RSCN changes to devices or hosts.
Virtual Fabrics	<p>Virtual Fabrics and Admin Domains are mutually exclusive and are not supported at the same time on a switch. To use Admin Domains, you must first disable Virtual Fabrics; to use Virtual Fabrics, you must first delete all Admin Domains.</p> <p>If you connect a switch with Admin Domains to a Virtual Fabric-enabled switch, the link is segmented with the reason "VF AD conflict."</p>

## Admin Domains, zones, and zone databases

If you are working with zones, you should be aware of how they impact Admin Domains. Each AD has its own zone database, with both defined and effective zone configurations and all related zone objects (zones, zone aliases, and zone members). Within an Admin Domain, you can configure zoning only with the devices that are present in that Admin Domain.

With a hierarchical zoning model, the name space for each Admin Domain and the root zones are separate; configurations are supported with the same zone object name appearing in the root zone database and different ADs (for example, the same zoneset name in AD1 and AD2).



Zoning operations ignore any resources not in the Admin Domain, even if they are specified in the zone. The behavior functions similarly to specifying offline devices in a zone. All zones from each AD zone configuration are enforced. The enforcement policy encompasses zones in the effective zone configuration of the root zone database and the effective zone configurations of each AD.

Using the **zone --validate** command, you can see all zone members that are not part of the current zone enforcement table but *are* part of the zoning database.

A member might not be part of the zone enforcement table because:

- The device is offline.
- The device is online but is not part of the current Admin Domain.

See [“Validating a zone”](#) on page 251 for instructions on using the **zone --validate** command. For more information about the **zone** command and its use with Admin Domains, see the *Fabric OS Command Reference*.

---

#### NOTE

AD zone databases do not have an enforced size limit. The zone database size is calculated by the upper limit of the AD membership definition and the sum of all the zone databases for each AD.

---

Admin Domains support the default zone mode of **noaccess** only. Before configuring any Admin Domain, you must set the default zone to **noaccess** mode. Admin Domains without effective zone configurations are presented with **noaccess**. See [“Default zoning mode”](#) on page 252 for more information.

If the administrative domain feature is not active (AD1–AD254 are not configured and no explicit members are added to ADO), ADO supports both **allaccess** and **noaccess** default zone modes.

Admin Domains introduce two types of zone database nomenclature and behavior:

- Root zone database

If you do not use Admin Domains, there is only one zone database. This legacy zone database is known as the *root zone database*. If you create Admin Domains, several zone databases exist: the root zone database, which is owned by ADO, and other zone databases, one for each user-defined Admin Domain.

AD-level zone information is merged with the root zone configuration and enforced.

- Zone databases

The Admin Domains each have separate zone databases and zone transaction buffers. You can concurrently edit the separate zone databases. The AD zone database also has the following characteristics:

- Each Admin Domain (AD1 through AD254) has its own zone definitions. These zone definitions include defined and effective zone configurations and all related zone objects including zones, zone aliases, and zone members. For example, you can define a zone name of `test_z1` in more than one Admin Domain.
- Each zone database has its own namespace.
- There is no zone database linked to the physical fabric (AD255) and no support for zone database updates. In the physical fabric context (AD255), you can only view the complete hierarchical zone database, which is made up of the zone databases in ADO through AD254.
- With AD support, zoning updates are supported selectively at each AD level. For example, a zone change in AD1 results in an update request only for the AD1 zone database.

## Admin Domains and LSA zones

LSANs under each Admin Domain are collated into a single name space and sent out to FCR phantom domains using the following format:

```
<original_LSAN_name>_AD<AD_num>
```

For example, a zone with name *lsan\_for\_linux\_farm* in AD5 is internally converted to *lsan\_for\_linux\_farm\_AD005*.

LSAN zone names in AD0 are never converted for backward compatibility reasons.

The auto-converted LSAN zone names might collide with LSAN zone names in AD0 (for example, in the above example, if AD0 contains *lsan\_for\_linux\_farm\_AD005*, this causes a name collision). Fabric OS does not detect or report such name clashes.

LSAN zone names greater than 57 characters are not converted or sent to the FCR phantom domain. See [Chapter 21, "Using the FC-FC Routing Service,"](#) for information about LSAN zones.

## Configuration upload and download in an AD context

The behavior of the **configUpload** and **configDownload** commands varies depending on the AD context and whether the switch is a member of the current Admin Domain. In the AD context, these commands include only the zone configuration of the current Admin Domain. If the switch is a member of the Admin Domain, all switch configuration parameters are saved and the zone database for that Admin Domain is also saved.

[Table 76](#) lists the sections in the configuration file and the Admin Domain contexts in which you can upload and download these sections. See [Chapter 8, "Maintaining the Switch Configuration File,"](#) for additional information about uploading and downloading configurations.

### NOTE

You cannot use **configDownload** to restore a single Admin Domain. To restore a single Admin Domain, you must first delete all Admin Domains and then issue **configDownload** to restore them.

**TABLE 76** Configuration upload and download scenarios in an AD context

AD contexts	Configuration file sections				
	iSCSI	ACL	Zone	AD headers	Switch configuration and other parameters
AD255: With ADs	Yes	Yes	Yes <sup>1</sup>	Yes	Yes
Without ADs	Yes	Yes	Yes <sup>1</sup>	Yes	Yes
AD0: With ADs and switch membership	Yes	No	Yes <sup>2</sup>	No	Yes
With ADs and without switch membership	Yes	No	Yes <sup>2</sup>	No	No
Without ADs	Yes	Yes	Yes <sup>2</sup>	No	Yes
AD1 – AD254: With switch membership	No	No	Yes <sup>3</sup>	No	Yes
Without switch membership	No	No	Yes <sup>3</sup>	No	No

1. Zone databases for AD0 through AD254.
2. Only zone database for AD0.
3. Only zone database for current AD.

The **configDefault** command does not clear zone or Admin Domain database information. This command is allowed only if the switch is a member of the current Admin Domain.

## *Licensed Features*

This section describes optionally licensed Brocade Fabric OS features and includes the following chapters:

- [Chapter 16, “Administering Licensing”](#)
- [Chapter 17, “Monitoring Fabric Performance”](#)
- [Chapter 18, “Optimizing Fabric Behavior”](#)
- [Chapter 19, “Managing Trunking Connections”](#)
- [Chapter 20, “Managing Long Distance Fabrics”](#)
- [Chapter 21, “Using the FC-FC Routing Service”](#)



# Administering Licensing

---

## In this chapter

- Licensing overview. . . . . 365
- The Brocade 7800 Upgrade license . . . . . 371
- ICL licensing. . . . . 371
- 8G licensing. . . . . 372
- Slot-based licensing . . . . . 372
- Time-based licenses . . . . . 373
- Universal Time-based licenses . . . . . 374
- Viewing installed licenses . . . . . 375
- Activating a license . . . . . 375
- Adding a licensed feature . . . . . 376
- Removing a licensed feature . . . . . 377
- Ports on Demand. . . . . 377

## Licensing overview

Feature licenses may be part of the licensed paperpack supplied with your switch software; if not, you can purchase licenses separately from your switch vendor, who will provide you with transaction keys to unlock the features. License keys are provided on a per-product and per-feature basis. Each switch within a fabric needs its own licensing.

---

### NOTE

To preserve licenses on your switch, perform a **configUpload** prior to upgrading or downgrading your Fabric OS.

---

If you downgrade your Fabric OS to an earlier version, some licenses associated with specific features of Fabric OS may not work.

Licences can be associated with a feature version. If a feature has a version-based license, that license is valid only for a particular version of the feature. If you want a newer version of the feature, you must purchase a new license. If a license is not version-based, then it is valid for all versions of the feature.

Fabric OS includes basic switch and fabric support software, and support for optionally licensed software that is enabled using license keys. [Table 77](#) lists the optionally licensed features that are currently available:

TABLE 77 Available Brocade licenses

License	Description
10GbE License	<p>This license enables the two 10GbE ports on the FX8-24. With this license, two additional operating modes (in addition to 10 1GbE ports mode) can be selected:</p> <ul style="list-style-type: none"> <li>• 10 1GbE ports and 1 10GbE port, or</li> <li>• 2 10GbE ports</li> </ul> <p>This license is available on the Brocade 7800 switch, and the Brocade DCX and DCX-4S for the FX8-24 on an individual slot basis.</p>
7500E Upgrade	<p>This license allows you to upgrade a 4-port (2 FC ports and 2 GbE ports) 7500E base switch to a full 18-port (16 FC ports and 2 GbE ports) 7500 switch configuration and feature capability. The upgraded 7500E Extension Switch includes the complete High Performance Extension license feature set.</p>
7800 Upgrade License	<p>This license enables full hardware capabilities on the Brocade 7800 base switch, increasing the number of Fibre Channel ports from four to sixteen and the number of GbE ports from two to six. A Brocade 7800 switch with the Upgrade License also supports up to eight FCIP tunnels instead of two and supports advanced capabilities like tape read/write pipelining. The Brocade 7800 switch must have the Upgrade License to add FICON Management Server (CUP) or Advanced Accelerator for FICON.</p>
Adaptive Networking with QoS	<p>Adaptive Networking provides a rich framework of capability allowing you to ensure high priority connections obtain the bandwidth necessary for optimum performance, even in congested environments. The QoS SID/DID Prioritization and Ingress Rate Limiting features are the first components of this license option, and are fully available on all 8 Gbps platforms.</p>
Advanced Extension License	<p>This license enables two advanced extension features: FCIP Trunking and Adaptive Rate Limiting. The FCIP Trunking feature allows multiple (up to 4) IP source and destination address pairs (defined as FCIP Circuits) using multiple (up to 4) 1 GbE or 10 GbE interfaces to provide a high bandwidth FCIP tunnel and failover resiliency. In addition, each FCIP circuit supports four QoS classes (Class-F, high, medium and low priority), each as a TCP connection. The Adaptive Rate Limiting feature provides a minimum bandwidth guarantee for each tunnel with full utilization of the available network bandwidth without impacting throughput performance under high traffic load. This license is available on the Brocade 7800 switch, and the Brocade DCX and DCX-4S for the FX8-24 on an individual slot basis.</p>
Advanced FICON Acceleration	<p>This licensed feature uses specialized data management techniques and automated intelligence to accelerate FICON tape read and write and IBM Global Mirror data replication operations over distance, while maintaining the integrity of command and acknowledgement sequences. This license is available on the Brocade 7800 switch, and the Brocade DCX and DCX-4S for the FX8-24 on an individual slot basis.</p>
Brocade Advanced Performance Monitoring	<p>Enables performance monitoring of networked storage resources. This license includes the Top Talkers feature.</p>
Brocade Extended Fabrics	<p>Provides greater than 10km of switched fabric connectivity at full bandwidth over long distances (depending on the platform this can be up to 3000km).</p>

**TABLE 77 Available Brocade licenses (Continued)**

License	Description
Brocade Fabric Watch	Monitors mission-critical switch operations. Fabric Watch includes Port Fencing capabilities.
Brocade ISL Trunking	Provides the ability to aggregate multiple physical links into one logical link for enhanced network performance and fault tolerance. Also includes Access Gateway ISL Trunking on those products that support Access Gateway deployment.
Brocade Ports on Demand	Allows you to instantly scale the fabric by provisioning additional ports using license key upgrades. Applies to the Brocade 300, 4100, 4900, 5000, 5100, 5300, and VA-40FC switches.
DataFort Compatibility License	Provides the Brocade Encryption Switch, the Brocade DCX and DCX-4S with FS8-18 blade to read and decrypt the NetApp DataFort-encrypted Disk LUNs and Tapes. DataFort Compatible License is also required on the Brocade Encryption Switch, the Brocade DCX and DCX-4S with FS8-18 blade to write and encrypt the Disk LUNs and Tapes in NetApp DataFort Compatible Format (metadata, encryption, algorithm, and compression algorithm) so that DataFort can read and decrypt these tapes and disk LUNs. Availability of this license is limited; contact your vendor for details.
Encryption Performance Upgrade License	Provides additional encryption bandwidth on encryption platforms. For the Brocade Encryption Switch, two Encryption Performance Upgrade licenses can be installed to enable the full available bandwidth. On a Brocade DCX and DCX-4S, a single Performance License can be installed to enable full bandwidth on all FS8-18 blades installed in the chassis.
Enhanced Group Management	Enables full management of the 8 Gbps platforms in a datacenter fabric with deeper element management functionality and greater management task aggregation throughout the environment.
FCoE License	Enables Fibre Channel over Ethernet (FCoE) functionality on the Brocade 8000 switch. This license is included by default for the Brocade 8000 switch.
FICON Management Server (Also known as "CUP", Control Unit Port)	Enables host-control of switches in mainframe environments.
High Performance Extension over FCIP/FC (formerly known as "FC-IP Services")	Includes the FC-Fastwrite feature and IPsec capabilities. Applies to FR4-18i blade and Brocade 7500.
ICL 16-link License, or Inter Chassis Links	Provides dedicated high-bandwidth links between two Brocade DCX chassis, without consuming valuable front-end 8 Gbps ports. Each chassis must have the ICL license installed in order to enable the full 16-link ICL connections. (Available on the DCX only.)
ICL 8-Link License	Activates all eight links on ICL ports on a Brocade DCX-4S chassis or half of the ICL bandwidth for each ICL port on the Brocade DCX platform by enabling only eight links out of the sixteen links available. This allows you to purchase half the bandwidth of DCX ICL ports initially and upgrade with an additional 8-link license to utilize the full ICL bandwidth at a later time. This license is also useful for environments that wish to create ICL connections between a DCX and a DCX-4S, the latter of which cannot support more than 8 links on an ICL port. Available on the Brocade DCX and DCX-4S platforms only (This license replaces the original ICL license for the DCX-4S).

**TABLE 77 Available Brocade licenses (Continued)**

License	Description
Integrated Routing	Allows any ports in a Brocade 5100, 5300, and VA-40FC switches, the Brocade Encryption Switch, or the Brocade DCX and DCX-4S platforms to be configured as an EX_Port supporting Fibre Channel Routing. This eliminates the need to add an FR4-18i blade or use the 7500 for FCR purposes, and also provides double the bandwidth for each FCR connection when connected to another 8 Gbps-capable port.
Server Application Optimization	When deployed with Brocade Server Adapters, this license optimizes overall application performance for physical servers and virtual machines by extending virtual channels to the server infrastructure. Application specific traffic flows can be configured, prioritized, and optimized throughout the entire data center infrastructure. This license is not supported on the Brocade 8000. For more information on this license, refer to the <i>Brocade Adapters Administrator's Guide</i> .

Table 78 lists the licenses that must be installed on the local switch and any connecting switches to use the feature.

**TABLE 78 License requirements**

Feature	License	Where license should be installed
Adaptive Rate Limiting	Advanced Extension	Local switch.
Administrative Domains	No license required.	n/a
Bottleneck Detection	No license required.	n/a
Configuration up/download	No license required. Configupload or configdownload is a command and comes with the OS on the switch.	n/a
Converged Enhanced Ethernet	Requires FCoE base license and POD1 license. <b>NOTE:</b> These licenses are installed by default and you should not remove them.	Local switch. Brocade 8000 only.
Data Center Fabric Manager	No license required for base use.	For more information on this products licensing, refer to the <i>Data Center Fabric Manager Professional User Manual</i> .
Diagnostic tools	No license required.	n/a
Distributed Management Server	No license required.	n/a
EX_Ports	Integrated Routing	Local switch.
Extended Fabrics	Extended Fabrics	Local switch and attached switches.
Fabric Watch	No license required for base use.	For more information on this products licensing, refer to the <i>Fabric Watch Administrator's Guide</i> .
FC Fastwrite	FC-IP Services or High Performance Extension over FCIP/FC	Local and attached switches.
FCIP	FC-IP Services or High Performance Extension over FCIP/FC	Local and attached switches. License is needed on both sides of tunnel.
FCIP Trunking	Advanced Extension	Local and attached switches.



TABLE 78 License requirements (Continued)

Feature	License	Where license should be installed
Fibre Channel Routing	IR	Local and attached switches.
FICON	No license required.	n/a
FICON-CUP	FICON Management Server	Local switch.
FICON Tape Read and Write Emulation over an FCIP Tunnel	FICON Tape High-Performance Extension over FCIP/FC license or Advanced FICON Acceleration on Brocade 7800	Local and attached switches.
FICON XRC Sequence Emulation over an FCIP Tunnel	FICON XRC High-Performance Extension over FCIP/FC or Advanced FICON Acceleration on Brocade 7800	Local and attached switches.
FIPS	No license required.	n/a
Firmware download	No license required. Firmwaredownload is a command and comes with the OS on the switch.	n/a
Full fabric connectivity	Full Fabric. This license is also called the Fabric license (in <b>licenseShow</b> output) and E_Port Upgrade license.	Local switch. May be required on attached switches.
Inband Management	No license required.	n/a
Ingress rate limiting	Adaptive Networking	Local switch.
Integrated routing	Integrated Routing	Local switch.
Inter-chassis link (ICL)	ICL 8-link on the Brocade DCX and DCX-4S. ICL 16-link on the Brocade DCX only.	Local and attached platforms.
Interoperability	No license required.	n/a
IPSec	No license required.	n/a
IPsec for FCIP tunnels	FC-IP Services or High Performance Extension over FCIP/FC	Local and attached switches. License is needed on both sides of tunnel.
LDAP	No license required.	n/a
Logical fabric	No license required.	n/a
Logical switch	No license required.	n/a
Long distance	Extended Fabrics	Local and attached switches. License is needed on both sides of connection.
NPIV	No license required.	n/a
OpenSSH public key	No license required.	n/a
Performance monitoring	Basic features - no Advanced features - yes: Performance Monitoring.	Local switch.
Port fencing	Fabric Watch	Local switch.

**TABLE 78 License requirements (Continued)**

Feature	License	Where license should be installed
Ports	Ports on demand licenses. This license applies to a select set of switches. Upgrade license for the 7500E and 7800 switches to use all ports. 10 Gigabit Ethernet license to use 10GbE ports on FX8-24 blade. Brocade 8000 – Must have license installed to enable the 8 FC ports. A maximum of 8 FC ports are allowed.	Local switch.
QoS	Adaptive Networking	Local switch and attached switches.
QoS on an HBA	Server Application Optimization and Adaptive Networking	Local switch
RADIUS	No license required.	n/a
RBAC	No license required.	n/a
Routing traffic	No license required. This includes port-based or exchanged-based routing, static routes, frame-order deliver, and dynamic routes.	n/a
Security	No license required. Includes the DCC, SCC, FCS, IP Filter, and authentication policies.	n/a
SNMP	No license required.	n/a
Speed	8 Gbps license needed to support 8 Gbps on the Brocade 300, 5100, 5300, and VA-40FC switches and embedded switches only. <b>NOTE:</b> This license is installed by default and you should not remove it.	Local switch
SSH public key	No license required.	n/a
Top Talkers	Advanced Performance Monitoring	Local switch and attached switches.
Traffic Isolation	No license required.	n/a
Trunking	ISL Trunking or ISL Trunking Over Extended Fabrics	Local and attached switches.
Two-to-four domains in a fabric	Value Line (Two/Four)	Local switch. May be required on attached switches.
USB usage	No license required.	n/a
Virtual Fabrics	No license required.	n/a
Web Tools	No license required.	Local and any switch you want to manage using Web Tools.
Zoning	No license required.	n/a

## The Brocade 7800 Upgrade license

The Brocade 7800 has four Fibre Channel (FC) ports and two GbE ports active by default. The number of physical ports active on the Brocade 7800 is fixed. There is one upgrade license to activate the rest of the FC and GbE ports for a total of 16 FC ports and six GbE ports. The Upgrade license activates FC and GbE ports, and also activates additional features outlined in [Table 79](#).

**TABLE 79** Base to Upgrade License Comparison

Feature	Base model	Upgrade License
Number of Fibre Channel (FC) ports	4	16
Number of GbE ports	2	6
Number of 10-GbE ports	0	0
Number of FCIP Tunnels	2	6
Tape Pipelining over FCIP Tunnel	No	Yes

## ICL licensing

Brocade ICL links operate between the Core blades on the DCX and DCX-4S enterprise-class platforms. Typically, if both Core blades are installed then they are active on the DCX and DCX-4S enterprise-class platforms.

ICL ports can be used only with an ICL license. ICL ports can be used only with an ICL license. On the Brocade DCX-4S, the ICL 8-link license enables all eight links in an ICL. However, on a Brocade DCX, the ICL 8-link license enables only eight links out of the 16 links within an ICL. If you are going to create ICLs between a Brocade DCX and DCX-4S, they only need the ICL 8-link license on both platforms. On the Brocade DCX-4S an ICL 16-link license would result in eight unused links because it can only support ICL connections with eight links. After the addition or removal of a license, the license enforcement is performed on the ICL ports only when the **portDisable** and **portEnable** commands are issued on the ports. An ICL license must be installed on both Brocade DCX and DCX-4S Backbones forming the ICL connection.

### ICL 16-link license

Provides dedicated high-bandwidth links between two Brocade DCX chassis, without consuming valuable front-end eight Gbps ports. Each Brocade DCX chassis must have the ICL 16-link license installed in order to enable the full 16-link ICL connections. This license is available for the Brocade DCX only.

### ICL 8-link license

This license activates all eight links on ICL ports on a Brocade DCX-4S chassis or half of the ICL bandwidth for each ICL port on the Brocade DCX platform by enabling only eight links out of the 16 links available. This allows you to purchase half the bandwidth of the Brocade DCX ICL ports initially and upgrade with an additional ICL 8-link license to utilize the full ICL bandwidth at a later time. This license is also useful for environments with ICL connections between a Brocade DCX and a DCX-4S, the latter of which cannot support more than eight links on an ICL port. Available on the Brocade DCX-4S and DCX platforms only.

## 8G licensing

---

**ATTENTION**

This license is installed by default and you should not remove it.

---

The 8 Gbps licensing applies to the Brocade 300, 5100, 5300, and VA-40FC switches and the 8 Gbps embedded switches. The Brocade 48000 does not need the 8G license to use any of the FC8- type blades. The following list describes the basic rules of using, adding, or removing 8G licenses.

- Without an 8G license, even if there is an 8 Gbps SFP plugged into a port in an applicable platform, the port would be enabled to run at a maximum speed of 4 Gbps.
- To obtain an 8G license, only the License ID from the switch is required. When you add the 8G license, you must enter either the **portDisable** and **portEnable** commands on each individual port on the switch, or the **switchDisable** and **switchEnable** commands on the switch, to enable the 8 Gbps functionality.
- When you remove the 8G license, the ports which are online and already running at 8 Gbps are not disturbed until the port goes offline or the switch is rebooted. The switch ports return to their pre-licensed state maximum speed of 4 Gbps.

## Slot-based licensing

Slot-based licensing is used on the Brocade DCX and DCX-4S platforms to support the FX8-24 blade, where capacity is equal to the number of slots. This license allows you to select the slots the license will enable up to the capacity purchased and to increase the capacity without disrupting slots that already have licensed features running. Each slot-based key is for a single feature. Features utilizing slot-based licenses on the FX8-24 blade include 10GbE, Advanced Extension, and Advanced FICON Acceleration. All prior blade features continue to be exclusively chassis-based licenses.

Any unassigned slot-based license can be automatically assigned to applicable blades that are detected in the chassis. If you have more applicable blades than available licenses you can manually assign or re-assign the licenses as necessary.

Once a license is assigned to a slot whether it has been auto- or manually-assigned, do not remove it unless manually done. This will allow for various maintenance operations to occur without having the license move around to other slots.

The following steps must be completed for a slot-based licensed feature to be active:

1. You must have a Slot-based license installed on the platform with sufficient slot count for the number of slots you plan to activate the feature on.
2. You must configure slots so that the licensed feature is assigned to slots. No more slots can be configured than specified in the license.
3. You must configure the application that uses the licensed feature on the blade in the slot. That operation verifies that the previous two steps have been successfully completed.

Once these steps are complete, the feature will work on the blade.

## Upgrade/downgrade considerations

When a Slot-based license is present on the switch, firmware downgrade to pre-Fabric OS v6.3.0 is allowed, but the Slot-based features that were licensed will not be functional.

## Adding a license to a slot

1. Connect to the switch and log in using an account assigned to the admin role.
2. Enter the `licenseSlotCfg -add` command to add the license the appropriate slot.

## Removing a license from a slot

To remove a Slot-based license from a blade slot and move the license to another slot, the following steps must be performed:

1. Connect to the switch and log in using an account assigned to the admin role.
2. You must deconfigure the application that uses the licensed feature on the blade slot.
3. The Slot-based license feature must be deconfigured.
4. Enter the `licenseSlotCfg -remove` command to remove the license from slot.

# Time-based licenses

A Time-based license applies a try-before-you-buy approach to certain features so that you can experience the feature and its capabilities prior to buying the license. Once you have installed the license, you are given a time limit to use the feature. The following lists the types of licenses that have this feature:

- 10GbE license
- Advanced Extension
- Advanced FICON Acceleration license
- Adaptive Networking
- Advanced Performance Monitoring
- Fabric
- Fabric Watch
- Extended Fabric
- High Performance Extension over FCIP/FC
- Integrated Routing
- Trunking

If you downgrade your switch to a version earlier than 6.1.0, the Time-based license will no longer be available. The license will remain on the switch, but you will not be able to use it.

Once the Time-base license is installed you cannot change the time of the switch until the Time-based license is removed. To change the time, you must remove the license, change the date, and then re-install the license on the switch. However, if there is any other mechanism that exists to change time, such as NTP, then it is not blocked. If you are using NTP to synchronize the time between your network devices, including switches or enterprise-class platforms, then do not attempt to change system date and time when a time-based license is installed.

## Configupload and download considerations

The **configDownload** and **configUpload** commands download the legacy, enhanced, consumed capacities, and time-based licenses.

## Expired licenses

Once a Time-based license has expired, you can view it through the **licenseShow** command. Expired licenses have an output string of 'License has expired'. RASlog warning messages are generated every hour for licenses present in the database which have expired or which are going to expire in the next five days.

### *Removing an expired license*



#### **CAUTION**

**The following procedure is disruptive to the switch.**

1. Connect to the switch and log in using an account assigned to the admin role.
2. Enter the **reboot** command for the expiry to take affect.

## Universal Time-based licenses

Universal Time-based licenses behave the same way as the Time-based temporary licenses supported in prior FOS versions. Prior to FOS v6.3.0 release, when a Time-based temporary license for a feature expires, the general policy is to allow the feature to continue working while generating warning messages until the switch is either reset or a CP failover occurs, at which time the feature will no longer work. When an expired license is replaced with a new license (permanent, or another time-based license) the warning messages cease (if no reset/failover has already happened since expiration) and, if a reset/failover has happened, the feature will work again. This behavior is also applicable to Universal Time-based Licenses.

## Universal Time-based license expiration date

Unlike prior temporary licenses that have a specific expiration date encoded in them, Universal Time-based license keys include a duration period. Once installed on a switch, this duration is decremented until there is no remaining time, at which point it is expired. Because of this, Universal Time-based licenses should not be installed on a switch until you are ready to use or test the feature, so as not to unnecessarily consume a portion of the temporary use duration.

The expiration date is based on the system time at the installation of the license plus the number of days that the Universal Time-based license is valid for. Universal Time-based licenses cannot be removed and reinstallation of the same Universal Time-based license on the same switch is not permitted.

## Extending a license

Extending a Universal Time-based license is done by adding a temporary license with expiry date after the Universal Time-based license expiry date, or by adding a permanent license. Re-applying an existing Universal Time-based license is not allowed.

## Deleting a license

Universal Time-based licenses are always retained in the license database, and cannot be explicitly deleted.

## Date change restriction

Once temporary licenses (including Universal Time-based licenses) are installed, you are not allowed to change the system date. If there is a need to change the date, you are expected to remove the time-based licenses and then change the date.

## Universal Time-based license shelf life

All Universal Time-based licenses are encoded with a “shelf life” expiration date. Once this date is reached, the time-based license can no longer be used on a switch. This expiration of the Universal Time-based license key provides a mechanism to discontinue offering of a particular feature.

# Viewing installed licenses

1. Connect to the switch and log in using an account assigned to the admin role.
2. Enter the **licenseShow** command.

# Activating a license

The transaction key is case-sensitive; it must be entered exactly as it appears in the paperpack. To lessen the chance of error, copy and paste the transaction key. The quotation marks are optional.

1. Take the appropriate following action based on whether you have a license key:
  - If you have a license key, go to [“Adding a licensed feature”](#).
  - If you do not have a license key and are using a transaction key, launch an Internet browser and go to the Brocade Web site at <http://www.brocade.com>.
2. Select **Products > Software License Keys**.  
The **Software License Keys** instruction page appears.
3. Enter the requested information in the required fields and click **Next**.  
A verification screen appears.
4. Verify the information appears correctly.  
Click **Submit** if the information displayed is correct. If the information is incorrect, click **Previous**, correct the information, and click **Submit**.

An information screen displays the license keys and you will receive an e-mail with the software license keys and installation instructions.

## Adding a licensed feature

To enable a feature, go to the feature's appropriate section in this manual. Enabling a feature on a switch may be a separate task from adding the license.

For the Brocade 48000 director and the Brocade DCX and DCX-4S enterprise-class platforms, licenses are effective on both CP blades, but are valid only when the CP blade is inserted into an enterprise-class platform that has an appropriate license ID stored in the WWN card. If a CP is moved from one enterprise-class platform to another, the license works in the new enterprise-class platform only if the WWN card is the same in the new enterprise-class platform. Otherwise, you must transfer licenses from the old WWN to the new WWN.

For example, if you swap one CP blade at a time, or replace a single CP blade, then the existing CP blade (the active CP blade) propagates the licenses to the new CP blade.

If you move a standby CP from one enterprise-class platform to another, then the active CP will propagate its configuration (including license keys).

1. Connect to the switch and log in using an account assigned to the admin role.
2. Activate the license using the **licenseAdd** command.
3. Verify the license was added by entering the **licenseShow** command. The licensed features currently installed on the switch are listed. If the feature is not listed, enter the **licenseAdd** command again.

Some features may require additional configuration, or you may need to disable and re-enable the switch to make them operational; see the feature documentation for details.

```
switch:admin> licenseshow
aAYtMJg7tmMZrTZ9JTWBC4SXWLJMY3QfBJYHG:
  Fabric license
  Remote Switch license
  Remote Fabric license
  Extended Fabric license
  Entry Fabric license
  Fabric Watch license
  Performance Monitor license
  Trunking license
  4 Domain Fabric license
  FICON_CUP license
  High-Performance Extension over FCIP/FC license
  Full Ports on Demand license - additional 16 port upgrade license
  2 Domain Fabric license
  Integrated Routing license
  Storage Application Services license
  FICON Tape license
  FICON XRC license
  Adaptive Networking license
  Inter Chassis Link license
  Enhanced Group Management license
  8 Gig FC license
  DataFort Compatibility license
  Server Application Optimization license
```



## Removing a licensed feature

1. Connect to the switch and log in using an account assigned to the admin role.
2. Enter the **licenseShow** command to display the active licenses.
3. Remove the license key using the **licenseRemove** command.

The license key is case-sensitive and must be entered exactly as given. The quotation marks are optional. After removing a license key, the licensed feature is disabled when the switch is rebooted or when a switch disable and enable is performed.

4. Enter the **licenseShow** command to verify the license is disabled.

```
switch:admin> licenseshow
bQebzbRdScRfc0iK:
  Entry Fabric license
  Fabric Watch license
switch:admin> licenseremove "bQebzbRdScRfc0iK"
removing license key "bQebzbRdScRfc0iK"
```

After a reboot (or **switchDisable** and **switchEnable**), only the remaining licenses appear:

```
switch:admin> licenseshow
SybbzQQ9edTzcc0X:
  Fabric license
```

If there are no license keys, **licenseShow** displays “No licenses.”

## Ports on Demand

The Brocade models in the following list can be purchased with the number of licensed ports indicated. As your needs increase, you can activate unlicensed ports up to a particular maximum by purchasing and installing the optional Ports on Demand licensed product:

Brocade 300—Can be purchased with eight ports and no E\_Port, eight ports with full fabric access, or 16 ports with full fabric access. A maximum of 16 ports is allowed; eight-port systems can be upgraded in four-port increments. An E\_Port license upgrade is also available for purchase.

Brocade 4100 and 5000—Can be purchased with 16, 24, or 32 licensed ports. A maximum of 32 ports is allowed.

Brocade 4900—Can be purchased with 32, 48, or 64 licensed ports. A maximum of 64 ports is allowed.

Brocade 5100—Can be purchased with 24, 32, or 40 licensed ports. A maximum of 40 ports is allowed.

Brocade 5300—Can be purchased with 48, 64, or 80 licensed ports. A maximum of 80 ports is allowed.

Brocade 8000—Must have license installed to enable the 8 FC ports. A maximum of 8 ports are allowed.

Brocade VA-40FC—Can be purchased with 24, 32, or 40 licensed ports. A maximum of 40 ports is allowed.

**ATTENTION**

Licenses are not interchangeable between units. For example, if you bought a POD license for a Brocade 300, you cannot use that license on a Brocade 5100 or VA-40FC. The licenses are based on the switches WWN and are not interchangeable.

Table 80 shows the ports that are enabled by default and the ports that can be enabled after you install the first and second Ports on Demand licenses for each switch type.

**TABLE 80** List of available ports when implementing PODs

Platform	Available user ports		
	No POD license	POD1 or POD2 present	Both POD license present
Brocade 300	0-7	0-15	0-23
Brocade 4100	0-15	0-23	0-31
Brocade 4900	0-31	0-47	0-63
Brocade 5000	0-15	0-23	0-31
Brocade 5100	0-23	0-31	0-39
Brocade 5300	0-47	0-63	0-79
Brocade 5410	0-11	n/a	0-11
Brocade 5424	1-8 and 17-20	POD1: 0, 9-16, and 21-23	0-23
Brocade 5450	1-10 and 19-22	POD1: 0, 11-18, and 23-25	0-25
Brocade 5480	1-8 and 17-20	POD1: 9-12 and 21-22 POD2: 0, 13-16, and 23	0-23
Brocade 8000	24 Gbe	24 Gbe and 8 FC	24 Gbe and 8 FC
Brocade VA-40FC	0-23	0-31	0-39

Ports on Demand is ready to be unlocked in the switch firmware. Its license key may be part of the licensed paperpack supplied with switch software, or you can purchase the license key separately from your switch vendor. You may need to generate a license key from a transaction key supplied with your purchase. If so, launch an Internet browser and go to the Brocade Web site at <http://www.brocade.com>. Click **Products > Software Products > Software License Keys** and follow the instructions to generate the key.

Each Ports on Demand license activates the next group of ports in numerical order in either four-port or eight-port increments, depending on the model. Before installing a license key, you must insert transceivers in the ports to be activated. Remember to insert the transceivers in the lowest group of inactive port numbers first. For example, if only 16 ports are currently active and you are installing one Ports on Demand license key, make sure to insert the transceivers in ports 16 through 23. If you later install a second license key, insert the transceivers in ports 24 through 31. For details on inserting transceivers, see the switch's *Hardware Reference Manual*.

**ATTENTION**

If you enable or disable an active port you will disrupt any traffic and potentially lose data flowing on that port.

If the port is connected to another switch, you will segment the switch from the fabric and all traffic flowing between the disabled port and the fabric will be lost.

If you remove a Ports on Demand license, the licensed ports will become disabled after the next platform reboot or the next port deactivation.

## Activating Ports on Demand

1. Connect to the switch and log in using an account assigned to the admin role.
2. Verify the current states of the ports, using the **portShow** command.  
In the **portShow** output, the Licensed field indicates whether the port is licensed.
3. Install the Brocade Ports on Demand license.  
For instructions on how to install a license, see [“Adding a licensed feature”](#) on page 376.
4. Use the **portEnable** command to enable the ports.  
Alternatively, you can disable and re-enable the switch to activate ports.
5. Use the **portShow** command to check the newly activated ports.

## Dynamic Ports on Demand

The Brocade 4016, 4018, 4020, and 4024 switch modules are for bladed servers. These switches support the Dynamic Ports on Demand (POD) feature. The Dynamic POD feature automatically assigns POD licenses from a pool of available licenses based on the server blade installation.

The Dynamic POD feature detects and assigns ports to a POD license only if the server blade is installed with an HBA present. A server blade that does not have a functioning HBA is treated as an inactive link during initial POD port assignment.

The Dynamic POD feature assigns the ports to the POD license as they come online. Typically, assignments are sequential, starting with the lowest port number. However, variations in the equipment attached to the ports can cause the ports to take different amounts of time to come online. This means that the port assignment order is not guaranteed.

If the switch detects more active links than allowed by the current POD licenses, then some ports will not be assigned a POD license. Ports that do not receive a POD assignment have a state of *No Sync* or *In Sync*; these ports are not allowed to progress to the online state. Ports that cannot be brought online because of insufficient POD licenses have a state of *(No POD License) Disabled*. You can use the **switchShow** command to display the port states.

## Displaying the port license assignments

When you display the available licenses, you can also view the current port assignment of those licenses and the POD method state of dynamic or static.

1. Connect to the switch and log in using an account assigned to the admin role.
2. Enter the **licensePort --show** command.

### Example of manually assigned POD licenses.

```
switch:admin> licenseport --show
 24 ports are available in this switch
  Full POD license is installed
  Static POD method is in use
 24 port assignments are provisioned for use in this switch:
    12 port assignments are provisioned by the base switch license
    12 port assignments are provisioned by a full POD license
 24 ports are assigned to installed licenses:
    12 ports are assigned to the base switch license
```

```

    12 ports are assigned to the full POD license
Ports assigned to the base switch license:
    1, 2, 3, 4, 5, 6, 7, 8, 17, 18, 19, 20
Ports assigned to the full POD license:
    0, 9, 10, 11, 12, 13, 14, 15, 16, 21, 22, 23

```

## Enabling Dynamic Ports on Demand

If the switch is in the Static POD mode, then activating the Dynamic POD will erase any prior port license assignments the next time the switch is rebooted. The static POD assignments become the initial Dynamic POD assignments. After the Dynamic POD feature is enabled, you can customize the POD license associations.

The Dynamic POD feature is supported on the Brocade 4016, 4018, 4020, and 4024 switch modules only.

1. Connect to the switch and log in using an account assigned to the admin role.
2. Enter the **licensePort --method dynamic** command with the **dynamic** option to change the license assignment method to dynamic.

```

switch:admin> licenseport --method dynamic
The POD method has been changed to dynamic.
Please reboot the switch now for this change to take effect.

```

3. Enter the **reboot** command to restart the switch.

```

switch:admin> reboot

```

4. Enter the **licensePort --show** command to verify the switch started the Dynamic POD feature.

```

switch:admin> licenseport --show
 24 ports are available in this switch
  Full POD license is installed
  Dynamic POD method is in use
 24 port assignments are provisioned for use in this switch:
    12 port assignments are provisioned by the base switch license
    12 port assignments are provisioned by a full POD license
  8 ports are assigned to installed licenses:
    8 ports are assigned to the base switch license
    0 ports are assigned to the full POD license
Ports assigned to the base switch license:
  1, 2, 5, 6, 8*, 21, 22, 23
Ports assigned to the full POD license:
  None
Ports not assigned to a license:
  0, 3, 4, 7, 9, 10, 11, 12, 13, 14, 15, 16, 17, 18, 19, 20

16 license reservations are still available for use by unassigned ports
 1 license assignment is held by an offline port (indicated by *)

```

## Disabling Dynamic Ports on Demand

Disabling the Dynamic POD feature changes the POD method to *static* and erases any prior port license associations or assignments the next time the switch is rebooted.

1. Connect to the switch and log in using an account assigned to the admin role. Enter the **licensePort --method** command with the **static** option to change the license assignment method to static.

```
switch:admin> licenseport --method static
The POD method has been changed to static.
Please reboot the switch now for this change to take effect.
```

2. Enter the **reboot** command to restart the switch.
3. Enter the **licensePort --show** command to verify the switch started the Static POD feature.

```
switch:admin> licenseport --show
24 ports are available in this switch
Full POD license is installed
Static POD method is in use
24 port assignments are provisioned for use in this switch:
12 port assignments are provisioned by the base switch license
12 port assignments are provisioned by a full POD license
24 ports are assigned to installed licenses:
12 ports are assigned to the base switch license
12 ports are assigned to the full POD license
Ports assigned to the base switch license:
1, 2, 3, 4, 5, 6, 7, 8, 17, 18, 19, 20
Ports assigned to the full POD license:
0, 9, 10, 11, 12, 13, 14, 15, 16, 21, 22, 23
```

## Reserving a port license

You can allocate licenses by reserving and releasing POD assignments to specific ports. Disabled ports are not candidates for automatic license assignment by the Dynamic POD feature. Persistently disable an otherwise viable port to prevent it from coming online, and thereby preserve a license assignment for another port.

Reserving a license for a port assigns a POD license to that port whether the port is online or offline. That license will not be available to other ports that come online before the specified port.

To allocate licenses to a specific port instead of automatically assigning them as the ports come online, reserve a license for the port. The port receives a POD assignment if any are available.

1. Connect to the switch and log in using an account assigned to the admin role.
2. Enter the **licensePort --show** command to verify there are port reservations available.

```
switch:admin> licenseport --show
24 ports are available in this switch
Full POD license is installed
Dynamic POD method is in use
24 port assignments are provisioned for use in this switch:
12 port assignments are provisioned by the base switch license
12 port assignments are provisioned by a full POD license
10 ports are assigned to installed licenses:
10 ports are assigned to the base switch license
0 ports are assigned to the full POD license
Ports assigned to the base switch license:
1*, 2*, 3*, 4*, 5*, 6*, 8*, 21, 22, 23
Ports assigned to the full POD license:
None
Ports not assigned to a license:
0, 7, 9, 10, 11, 12, 13, 14, 15, 16, 17, 18, 19, 20
```

- Take the following appropriate action based on whether port reservations are available:
  - If a port reservation is available, then issue the `licensePort --reserve` command to reserve a license for the port.

```
switch:admin> licenseport --reserve 0
```

- If all port reservations are assigned, select a port to release its POD license. Follow the instructions in [“Releasing a port from a POD set”](#) to release a port from its POD assignment. Once the port is released, you can reserve it.

## Releasing a port from a POD set

Releasing a port removes it from the POD set; the port appears as unassigned until it comes back online. Persistently disabling the port ensures that the port cannot come back online and be automatically assigned to a POD assignment. Before you can re-assign a license, you must disable the port and release the license.

After a port is assigned to the POD set, the port is licensed until it is manually removed from the POD port set. When a port is released from its POD port set (Base, Single, or Double), it creates a vacancy in that port set.

- Connect to the switch and log in using an account assigned to the admin role.
- Enter the `switchDisable` command to take the switch offline.
- Enter the `switchShow` command to verify the switch state is offline.
- Enter the `licensePort --release` command to remove the port from the POD license.

```
switch:admin> switchdisable
```

```
switch:admin> licenseport --release 0
```

- Enter the `licensePort --show` command to verify the port is no longer assigned to a POD set.

```
switch:admin> licenseport --show
24 ports are available in this switch
Full POD license is installed
Dynamic POD method is in use
24 port assignments are provisioned for use in this switch:
12 port assignments are provisioned by the base switch license
12 port assignments are provisioned by a full POD license
10 ports are assigned to installed licenses:
10 ports are assigned to the base switch license
0 ports are assigned to the full POD license
Ports assigned to the base switch license:
1*, 2*, 3*, 4*, 5*, 6*, 8*, 21, 22, 23
Ports assigned to the full POD license:
None
Ports not assigned to a license:
0, 7, 9, 10, 11, 12, 13, 14, 15, 16, 17, 18, 19, 20
```

- Enter the `switchEnable` command to bring the switch back online.
- Enter the `switchShow` command to verify the switch state is now online.

# Monitoring Fabric Performance

---

## In this chapter

- [Advanced Performance Monitoring overview](#) ..... 383
- [End-to-end performance monitoring](#) ..... 385
- [Frame monitoring](#) ..... 389
- [ISL performance monitoring](#)..... 393
- [Top Talker monitors](#) ..... 393
- [Trunk monitoring](#) ..... 397
- [Displaying end-to-end and ISL monitor counters](#) ..... 397
- [Clearing end-to-end and ISL monitor counters](#) ..... 398
- [Saving and restoring monitor configurations](#)..... 399
- [Performance data collection](#)..... 399

## Advanced Performance Monitoring overview

Advanced Performance Monitoring is a licensed feature that provides a comprehensive tool for monitoring the performance of networked storage resources. Additional performance monitoring features, such as CRC error reports, are provided through Web Tools and DCFM. See the *Web Tools Administrator's Guide* and *DCFM User's Manual* for information about monitoring performance using a graphical interface.

Advanced Performance Monitor commands are available only to users with the admin or switchAdmin roles. Use the **perfhel** command to display a list of commands associated with Advanced Performance Monitoring.

---

### NOTE

The command examples in this chapter use the slot/port syntax required by Brocade 48000, Brocade DCX, and DCX-4S platforms. For Brocade 300, 4100, 4900, 5000, 5100, 5300, 5410, 5424, 5450, 5480, 7500, 7500E, 7600, 7800, 8000, VA-40FC, and the Brocade Encryption Switch, use only the port number where needed in the commands.

---

## Types of monitors

Advanced Performance Monitoring provides the following monitors:

- End-to-End monitors measure the traffic between a host/target pair.
- Frame monitors measure the traffic transmitted through a port with specific values in the first 64 bytes of the frame.

- ISL monitors measure the traffic transmitted through an InterSwitch Link (ISL) to different destination domains.
- Top Talkers monitors measure the flows that are major consumers of bandwidth on a switch or port.

The type of monitors supported depends on the switch model, as shown in [Table 81](#).

**TABLE 81** Types of monitors supported on Brocade switch models

Platform	Monitors:	EE	Frame	ISL	Top Talker
Brocade 300, 5300, 7800		Yes	Yes	No	Yes
Brocade 5410, 5424, 5450, and 5480		Yes	Yes	No	No
Brocade 4100, 4900, 5000, 7500, 7500E, 7600, and 48000		Yes	Yes	Yes	Yes
Brocade 5100, 8000 <sup>1</sup> , VA-40FC, Brocade Encryption Switch, Brocade DCX, Brocade DCX-4S		Yes	Yes	No	Yes

1. For the Brocade 8000, performance monitoring is supported only on the FC ports and not on the CEE ports.

**NOTE**

Advanced Performance Monitoring is not supported on VE\_Ports and EX\_Ports. If you issue commands for any Advanced Performance Monitors on VE\_Ports or EX\_Ports you will receive error messages.

## Virtual Fabrics considerations for Advanced Performance Monitoring

In a fabric with Virtual Fabrics enabled, the number of logical switches that can be configured with monitors is restricted. [Table 82](#) lists the platforms that support logical switches and, for each platform, the maximum number of logical switches that can support performance monitors.

**TABLE 82** Number of logical switches that support performance monitors

Platform	Maximum number of logical switches supported	Maximum number of logical switches on which monitors are supported
Brocade DCX	8	4
Brocade DCX-4S	8	4
Brocade 5100 Brocade VA-40FC	3	3
Brocade 5300	4	3

Each logical switch can have its own set of performance monitors. The installation of monitors is restricted to the ports that are present in the respective logical switch.

- Top Talker and end-to-end monitors are supported on the default logical switch, the base switch, and user-defined logical switches.
- Frame monitors are not supported on logical ISLs (LISLs) in user-defined logical switches.
- ISL monitors are not supported on any of the platforms listed in [Table 82](#).

If you move a port from one logical switch to another, the behavior of monitors installed on that port is as follows:

- **Frame monitor:** Any frame monitors on the port are deleted. To keep the frame monitor, you must manually install it on the port after the move.



- **Top Talker (fabric mode):** If fabric mode Top Talkers is enabled on the logical switch, a fabric mode Top Talker monitor is automatically installed on the port after it is moved to the logical switch.
- **Top Talker (port mode):** Any port mode Top Talker monitors on the port are deleted. To keep the port mode Top Talker monitor, you must manually install it on the port after the move.

## End-to-end performance monitoring

End-to-end performance monitoring counts the number of words in Fibre Channel frames for a specified Source ID (SID) and Destination ID (DID) pair. An end-to-end performance monitor includes these counts:

- RX\_COUNT - words in frames received at the port
- TX\_COUNT - words in frames transmitted from the port

To enable end-to-end performance monitoring, you must configure an end-to-end monitor on a port, specifying the SID-DID pair (in hexadecimal). The monitor counts only those frames with matching SID and DID.

Each SID or DID has the following three fields:

- Domain ID (DD)
- Area ID (AA)
- AL\_PA (PP)

For example, the SID 0x118a0f denotes DD 0x11, AA 0x8a, and AL\_PA 0x0f.

You can monitor end-to-end performance using the **perfMonitorShow** command, as described in [“Displaying end-to-end and ISL monitor counters”](#) on page 397. You can clear end-to-end counters using the **perfMonitorClear** command, as described in [“Clearing end-to-end and ISL monitor counters”](#) on page 398.

## End-to-end monitors

The maximum number of end-to-end monitors supported varies depending on the switch model:

- The Brocade 4100, 4900, 5000, 7500, 7500E, 7600, and 48000 models allow up to 256 end-to-end monitors shared by all ports in the same ASIC chip.
- The Brocade DCX, DCX-4S, 5100, 8000, VA-40FC, and Brocade Encryption Switch models allow up to 1024 end-to-end monitors shared by all ports in the same ASIC chip.
- The Brocade 300, 5300, 5410, 5424, 5450, 5480, and 7800 models allow up to 768 end-to-end monitors shared by all ports in the same ASIC chip.

The number of interswitch links configured on the switch affects the amount of resources available for end-to-end monitors.

The Brocade FC4-48 blade allows end-to-end monitors on all 48 ports.

For the FC4-16IP blade, end-to-end monitors are supported on the FC ports (ports 0 through 7), but not on the GbE ports.

You cannot add end-to-end monitors to interswitch links.

Identical end-to-end monitors cannot be added to the same port. Two end-to-end monitors are considered identical if they have the same SID and DID values after applying the end-to-end mask.

The monitor count is qualified using either of the following conditions:

- For frames received at the port with the end-to-end monitor installed, the frame SID is the same as “SourceID” and the frame DID is the same as “DestID”. The RX\_COUNT updated accordingly.
- For frames transmitted from the port with the end-to-end monitor installed, the frame DID is the same as “SourceID” and the frame SID is the same as “DestID”. The TX\_COUNT updated accordingly.

**Virtual Fabrics considerations:** If Virtual Fabrics is enabled, the Brocade DCX, DCX-4S, and 5300 models allow up to 256 end-to-end monitors on one logical switch. The Brocade 5100 and VA-40FC allow up to 337 end-to-end monitors on one logical switch.

## Adding end-to-end monitors

1. Connect to the switch and log in as admin.
2. Enter the following command:

```
perfaddeemonitor [slotnumber/]portnumber sourceID destID
```

Figure 58 shows two devices:

- Host A is connected to domain 5 (0x05), switch area ID 18 (0x12), AL\_PA 0x00 on Switch X.
- Dev B is a storage device connected to domain 17 (0x11), switch area ID 30 (0x1e), AL\_PA 0xef on Switch Y.

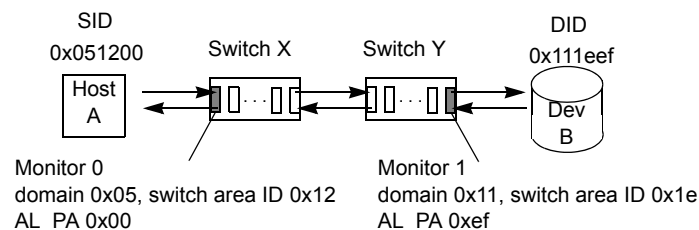

**FIGURE 58** Setting end-to-end monitors on a port

End-to-end performance monitoring looks at traffic on SID/DID pairs in any direction. That is, even if the SID is for a remote device, the traffic is monitored in both directions (the Tx/Rx counters are reversed).

### Example of monitoring the traffic from Host A to Dev B

Add Monitor 0 to slot 2, port 2 on Switch X, specifying 0x051200 as the SID and 0x111eef as the DID, as shown in the following example:

```
switch:admin> perfaddeemonitor 2/2, "0x051200" "0x111eef"
End-to-End monitor number 0 added.
```

Monitor 0 counts the frames that have an SID of 0x051200 and a DID of 0x111eef. For monitor 0, RX\_COUNT is the number of words from Host A to Dev B, and TX\_COUNT is the number of words from Dev B to Host A.

### Example of monitoring the traffic from Dev B to Host A

Add Monitor 1 to slot 2, port 14 on Switch Y, specifying 0x111eef as the SID and 0x051200 as the DID, as shown in the following example.

```
switch:admin> perfaddeemonitor 2/14, "0x111eef" "0x051200"
End-to-End monitor number 1 added.
```

Monitor 1 counts the frames that have an SID of 0x051200 and a DID of 0x111eef. For monitor 1, RX\_COUNT is the number of words from Dev B to Host A, and TX\_COUNT is the number of words from Host A to Dev B.

Figure 59 shows several switches and the correct ports on which to add performance monitors for a specified SID-DID pair.

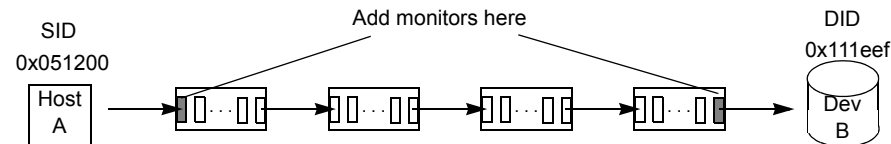

FIGURE 59 Proper placement of end-to-end performance monitors

## Setting a mask for an end-to-end monitor

End-to-end monitors count the number of words in Fibre Channel frames that match a specific SID/DID pair. If you want to match only part of the SID or DID, you can set a mask on the port to compare only certain parts of the SID or DID. By default, the frame must match the entire SID and DID to trigger the monitor. By setting a mask, you can choose to have the frame match only one or two of the three fields (Domain ID, Area ID, and AL\_PA) to trigger the monitor.

You specify the masks in the form *dd:aa:pp*, where *dd* is the domain ID mask, *aa* is the area ID mask, and *pp* is the AL\_PA mask. The values for *dd*, *aa*, and *pp* are either *ff* (the field must match) or *00* (the field is ignored). The default EE mask value is *ff:ff:ff*.

---

### NOTE

Only one mask per port can be set. When you set a mask, all existing end-to-end monitors are deleted.

---

End-to-end masks are not supported on the Brocade DCX, DCX-4S, 300, 5100, 5300, 5410, 5424, 5450, 5480, 7800, and VA-40FC models.

On FC4-48 port blades, the upper 32 ports can be addressed only when the area ID and the AL\_PA are used together. For usability concerns, the area ID and the AL\_PA cannot be masked separately for any ports on FC4-48 port blades.

1. Connect to the switch and log in as admin.
2. Enter the `perfSetPortEEMask` command.

```
perfsetporteemask [slotnumber/]portnumber "TxSIDMsk" "TxDIDMsk" "RxSIDMsk"
"RxDIDMsk"
```

The `perfSetPortEEMask` command sets the mask for all end-to-end monitors of a port. If any end-to-end monitors are programmed on a port when the `perfSetPortEEMask` command is issued, then a message displays similar to the following example:

```
switch:admin> perfsetporteemask 1/2, "00:ff:ff"
Changing EE mask for this port will cause ALL EE monitors on this port to be
deleted.
Continue? (yes, y, no, n): [no] y
The EE mask on port 2 is set and EE monitors on this port are deleted
```

The `perfSetPortEEMask` command sets a mask for the Domain ID, Area ID, and AL\_PA of the SIDs and DIDs for frames transmitted from and received by the port.

Figure 60 shows the mask positions in the command. A mask (“ff”) is set on slot 1, port 2 to compare the AL\_PA fields on the SID and DID in all frames (transmitted and received) on port 2. The frame SID and DID must match only the AL\_PA portion of the specified SID-DID pair. Each port can have only one EE mask. The mask is applied to all end-to-end monitors on the port. Individual masks for each monitor on the port cannot be specified.

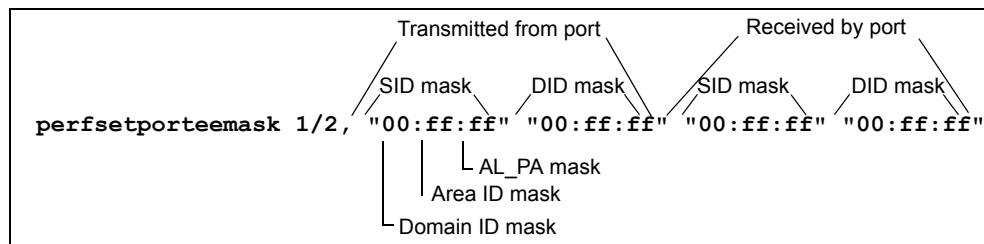

FIGURE 60 Mask positions for end-to-end monitors

## Deleting end-to-end monitors

1. Connect to the switch and log in as admin.
2. Enter the **perfMonitorShow** command to list the valid end-to-end monitor numbers for a port.
3. Enter the **perfDelEEMonitor** command to delete a specific monitor.

If you do not specify which monitor number to delete, you are asked if you want to delete all entries.

### Example

The following example displays the end-to-end monitors on port 0 (the monitor numbers are listed in the KEY column) and deletes monitor number 2 on port 0:

```
switch:admin> perfmonitorshow --class EE 0

There are 4 end-to-end monitor(s) defined on port 0.

KEY      SID      DID      OWNER_APP      TX_COUNT      RX_COUNT      OWNER_IP_ADDR
-----
0  0x000024  0x000016  WEB_TOOLS      0x0000000000000000  0x0000000000000000  10.106.7.179
1  0x000022  0x000033  WEB_TOOLS      0x0000000000000000  0x0000000000000000  10.106.7.179
2  0x000123  0x000789  WEB_TOOLS      0x0000000000000000  0x0000000000000000  10.106.7.179
3  0x001212  0x003434  WEB_TOOLS      0x0000000000000000  0x0000000000000000  10.106.7.179

switch:admin> perfdeleemonitor 0, 2
End-to-End monitor number 2 deleted
switch:admin>
```

## Frame monitoring

Frame monitoring counts the number of times a frame with a particular pattern is transmitted by a port and generates alerts when thresholds are crossed. Frame monitoring is achieved by defining a filter, or frame type, for a particular purpose. The frame type can be a standard type (for example, a SCSI read command filter that counts the number of SCSI read commands that have been transmitted by the port) or a user-defined frame type customized for your particular use. For a complete list of the standard, pre-defined frame types, see the **fmConfig** command description in the *Fabric OS Command Reference*.

### NOTE

The Advanced Performance Monitoring license is required to use the **fmConfig** command. The monitoring functionality, however, also requires the Fabric Watch license. When you configure actions and alerts through the **fmConfig** command, Fabric Watch uses these values and generates alerts based on the configuration. If you do not have a Fabric Watch license, these values are ignored. See the *Fabric Watch Administrator's Guide* for more information about using Fabric Watch.

The maximum number of frame monitors and offsets per port depends on the platform. [Table 83](#) shows the maximum number of frame monitors, in any combination of standard and user-defined frame types, and the maximum number of offsets per port.

**TABLE 83** Maximum number of frame monitors and offsets per port

Platform	Max number of frame monitors per port	Max number of offsets per port
Brocade 300, 5300, 5410, 5424, 5450, 5480, and 7800	8	8
Brocade 4100, 4900, 7500, 7500E, and 7600	12	16
Brocade 5000, 5100, 8000, VA-40FC, DCX, DCX-4S, and Brocade Encryption Switch	12	20
Brocade 4800 (all blades except FC4-48)	12	16
Brocade 48000 (FC4-48 blade):		
• Lower 16 ports (0 through 15)	12	16
• Middle 16 ports (16 through 31)	6	12
• Upper 16 ports (32 through 47)	0	0

The actual number of frame monitors that can be configured on a port depends on the complexity of the frame types. For trunked ports, the frame monitor is configured on the trunk master.

**Virtual Fabrics considerations:** Frame monitors are not supported on logical ISLs (LISLs), but are supported on ISLs and extended ISLs (XISLs).

This section describes frame monitoring using the **fmConfig** command. This command enhances and replaces the following legacy commands:

- **perfAddIPMonitor**
- **perfAddRWMonitor**
- **perfAddReadMonitor**
- **perfAddSCSIMonitor**
- **perfAddUserMonitor**
- **perfAddWriteMonitor**
- **perfDelFilterMonitor**

For the **perfMonitorShow** and **perfMonitorClear** commands, the management of filter monitors is provided through the **fmConfig** interface. While the legacy commands are still operational in the Fabric OS v6.4.0 release, their use is incompatible with the new **fmConfig** command. Once you use the **fmConfig** interface to configure and manage filter-based monitors, you can no longer use the old commands.

## Creating frame types to be monitored

In addition to the standard frame types, you can create custom frame types to gather statistics that fit your needs. To define a custom frame type, you must specify a series of *offsets*, *bitmasks*, and *values*. For all transmitted frames, the switch performs these tasks:

- Locates the byte found in the frame at the specified *offset*.
- Applies the *bitmask* to the byte found in the frame.
- Compares the new value with the given *value*.
- Increments the filter counter if a match is found.

You can specify up to four values to compare against each offset. If more than one offset is required to properly define a filter, the bytes found at each offset must match one of the given values for the filter to increment its counter. If one or more of the given offsets does not match any of the given values, the counter does not increment. The value of the offset must be between 0 and 63, in decimal format. Byte 0 indicates the first byte of the Start of Frame (SOF), byte 4 is the first byte of the frame header, and byte 28 is the first byte of the payload. Thus only the SOF, frame header, and first 36 bytes of payload can be selected as part of a filter definition. Offset 0 is a special case, which can be used to monitor the first 4 bytes of the frame (SOF). When the offset is set to 0, the values 0–7 that are checked against that offset are predefined as shown in [Table 84](#).

**TABLE 84** Predefined values at offset 0

Value	SOF	Value	SOF
0	SOFf	4	SOFi2
1	SOFc1	5	SOFn2
2	SOFi1	6	SOFi3
3	SOFn1	7	SOFn3

1. Connect to the switch and log in as admin.
2. Enter the **fmConfig --create** command to create a user-defined frame.

Complete details of the **fmConfig** command parameters are provided in the *Fabric OS Command Reference*. The **highth** and **action** options set values and actions for Fabric Watch, but do not apply monitoring. To apply the custom values, use the **thconfig --apply** command. See the *Fabric Watch Administrator's Guide* for more information about using this command.

### Example of creating a user-defined frame type

```
switch:admin> fmconfig --create MyFrameMonitor -pat
"17,0xFF,0x07;7,0x4F,0x01;" -action email
Create Success :0
```

### Example of creating a user-defined frame type and applying frame monitors to ports 3, 4, and 5

```
switch:admin> fmconfig --create MyFrameMonitor -pat
"17,0xFF,0x007;7,0x4F,0x01;" -port 3-5
Starting port :3 End port :5
Create Success :0
```

## Deleting frame types

Deleting a frame type removes the entire configuration, including configured thresholds and associated actions. It also removes any frame monitors of the specified type from all ports.

You can delete only user-defined frame types; you cannot delete the pre-defined frame types.

1. Connect to the switch and log in as admin.
2. Enter the **fmConfig --delete** command to delete a specific frame type.

### Example

```
switch:admin> fmconfig --delete MyFrameMonitor
```

## Adding frame monitors to a port

If the switch does not have enough resources to add a frame monitor to a port, then other frame monitors on that port might have to be deleted to free resources.

1. Connect to the switch and log in as admin.
2. Enter the **fmConfig --addmonitor** command to add a frame monitor to one or more ports.

The set of ports to be monitored is automatically saved to the persistent configuration unless you specify the **-nosave** option on this command.

3.

### Example

This example adds a standard SCSI frame type monitor to ports 3 through 12.

```
switch:admin> fmconfig --addmonitor SCSI -port 3-12
```

## Removing frame monitors from a port

1. Connect to the switch and log in as admin.
2. Enter the **fmConfig --delmonitor** command to remove a specific monitor from one or more ports.

The set of ports to be unmonitored is automatically saved to the persistent configuration unless you specify the **-nosave** option on this command.

### Example

The following example removes the user-defined frame monitor, MyFrameMonitor, from all ports.

```
switch:admin> fmconfig --delmonitor MyFrameMonitor
```

## Saving frame monitor configuration

If you assign or remove frame monitors on ports, the list of ports to be monitored is automatically saved persistently, unless you specify the **-nosave** option.

1. Connect to the switch and log in as admin.
2. Enter the **fmConfig --save** command to save the set of ports on which the frame type is monitored to the persistent configuration.

### Example

In this example, the first command adds a standard SCSI frame type monitor to ports 3 through 12, but does not save the port configuration. The second command saves the port configuration persistently.

```
switch:admin> fmconfig --addmonitor SCSI -port 3-12 -nosave

switch:admin> fmconfig --save SCSI
```

## Displaying frame monitors

1. Connect to the switch and log in as admin.
2. Enter the **fmConfig --show** command.

### Example

This example displays the existing frame types and associated bit patterns on the switch:

```
switch:admin> fmconfig --show
FRAME_TYPE      BIT  PATTERN
-----
scsi      12,0xFF,0x08;
           scsiread   12,0xFF,0x08;4,0xFF,0x06;40,0xFF,0x08,0x28;
           scsiwrite  12,0xFF,0x08;4,0xFF,0x06;40,0xFF,0x08,0x28,0x0A,0x2A;
           scsirw    12,0xFF,0x08;4,0xFF,0x06;40,0xFF,0x08,0x28,0x0A,0x2A;
           scsi2reserve 12,0xFF,0x08;4,0xFF,0x06;40,0xFF,0x16,0x56;
           scsi3reserve 12,0xFF,0x08;4,0xFF,0x06;40,0xFF,0x5F;41,0xFF,0x01
           ip       12,0xFF,0x05;
           abts    4,0xFF,0x81;40,0xFF,0x81;12,0xFF,0x0;17,0xFF,0x0;
           baacc   4,0xff,0x84;12,0xff,0x00;17,0xff,00;
```

This example displays configuration details for the pre-defined SCSI frame monitor. Note that in the last entry, the “-” in the Count column indicates that the monitor is configured, but is not installed on the port.

```
switch:admin> fmconfig --show SCSI

Port|Frame Type |Count           |HIGH Thres|Actions  |TIMEBASE  |CFG
-----
000001|scsi          |0x0000000000000123|1000      |Email    |None      |saved
000002|scsi          |0x0000000000000125|1000      |Email    |None      |saved
000003|scsi          |0x0000000000000143|1000      |Email    |None      |saved
000022|scsi          |-              |0         |None     |None      |saved
```

## Clearing frame monitor counters

1. Connect to the switch and log in as admin.
2. Enter the **fmConfig --clear** command to clear the counters on the ports on which the specified frame type is monitored.



**Example**

This example clears the counters for the ABTS monitor from ports 7 through 10.

```
switch:admin> fmconfig --clear ABTS -port 7-10
```

## ISL performance monitoring

ISL monitoring is set up on E\_Ports automatically.

An ISL monitor measures traffic to all reachable destination domains for an ISL, showing which destination domain is consuming the most traffic. If there are more than 16 domains, the monitor samples traffic and extrapolates the measurement.

EE monitors on E\_Ports are deleted when they become part of an ISL.

ISL monitors are deleted when Top Talker is installed and are restored when Top Talker is deleted. (See [“Top Talker monitors”](#) for information about monitor features and implementation.)

You can monitor ISL performance using the **perfMonitorShow** command, as described in [“Displaying end-to-end and ISL monitor counters.”](#) You can clear ISL counters using the **perfMonitorClear** command, as described in [“Clearing end-to-end and ISL monitor counters”](#) on page 398.

ISL monitoring is supported on a limited number of platforms. See [Table 81](#) on page 384 for the list of platforms on which ISL monitoring is supported.

**Virtual Fabrics considerations:** ISL monitors are supported only on the default logical switch and not on the base switch or other logical switches.

## Top Talker monitors

Top Talker monitors determine the flows (SID/DID pairs) that are the major users of bandwidth (after initial stabilization). Top Talker monitors measure bandwidth usage data in real-time and relative to the port on which the monitor is installed.

---

**NOTE**

*Initial stabilization* is the time taken by a flow to reach the maximum bandwidth. This time varies depending on the number of flows in the fabric and other factors. The incubation period can be up to 14 seconds in the Brocade DCX and DCX-4S, and up to 82 seconds in the Brocade 4100, 4900, 5000, 5100, 5300, 7500, 7500E, 7600, 7800, 8000, VA-40FC, 48000, and Brocade Encryption Switch.

---

Top Talker monitors are not supported on the CEE ports of the Brocade 8000 switch.

Applications can use the Top Talker data to do the following:

- Re-route the traffic through different ports that are less busy, so as not to overload a given port.
- Alert you to the top-talking flows on a port if the total traffic on the port exceeds the acceptable bandwidth consumption.

You can use Top Talkers to identify the SID/DID pairs that consume the most bandwidth and can then configure them with certain Quality of Service (QoS) attributes so they get proper priority. See [Chapter 18, “Optimizing Fabric Behavior,”](#) for information on QoS.

The Top Talker monitor is based on SID/DID and not WWNs. Once Top Talker is installed on a switch or port, it remains installed across power cycles.

Top Talkers supports two modes, port mode and fabric mode:

- Port mode Top Talker

A Top Talker monitor can be installed on an F\_Port to measure the traffic originating from the F\_Port and flowing to different destinations.

- Fabric mode Top Talker

In fabric mode, Top Talker monitors are installed on E\_Ports in the fabric and measure the data rate of all the possible flows in the fabric (ingress E\_Port traffic only). In fabric mode, Top Talker monitors can determine the top *n* bandwidth users on a given switch.

You can install Top Talker monitors either in port mode or fabric mode, but not both.

---

#### NOTE

A fabric mode Top Talker monitor and an end-to-end monitor cannot be configured on the same fabric. You must delete the end-to-end monitor before you configure the fabric mode Top Talker.

---

**How do Top Talker monitors differ from end-to-end monitors?** End-to-end monitors provide counter statistics for traffic flowing between a given SID-DID pair. Top Talker monitors identify all possible SID-DID flow combinations that are possible on a given port and provides a sorted output of the top talking flows. Also, if the number of flows exceeds the hardware resources, existing end-to-end monitors fail to get real time data for all of them; however, Top Talker monitors can monitor all flows for a given E\_Port or F\_Port.

**Virtual Fabric considerations:** All logical switches in the same chassis can use either fabric mode Top Talker monitors or port mode Top Talker and end-to-end monitors. You cannot use fabric mode Top Talker monitors and end-to-end monitors together on the same logical switch.

**Admin Domain considerations:** Top Talker monitors are always installed in AD255.

**NPIV considerations:** Top Talker takes NPIV devices into consideration when calculating the top talking flows.

## Adding a Top Talker monitor on an F\_Port

1. Connect to the switch and log in as admin.
2. Enter the `perfttmon --add` command.

```
perfttmon --add [egress | ingress] [slotnumber/]port
```

For example, to monitor the incoming traffic on port 7:

```
perfttmon --add ingress 7
```

To monitor the outgoing traffic on slot 2, port 4 on the Brocade 48000, Brocade DCX, or DCX-4S:

```
perfttmon --add egress 2/4
```

## Adding Top Talker monitors on all switches in the fabric (fabric mode)

When fabric mode is enabled, you can no longer install Top Talker monitors on an F\_Port unless you delete fabric mode.

1. Connect to the switch and log in as admin.
2. Remove any end-to-end monitors in the fabric, as described in “[Deleting end-to-end monitors](#)” on page 388. Fabric Mode Top Talker monitors and end-to-end monitors cannot both exist in the fabric.
3. Enter the **perfttmon --add fabricmode** command.

```
perfttmon --add fabricmode
```

The system responds:

```
Before enabling fabric mode, please remove all EE monitors in the fabric
continue? (yes, y, no, n):
```

4. Type **y** at the prompt to continue.

Top Talker monitors are added to E\_Ports in the fabric and fabric mode is enabled. Any Top Talker monitors that were already installed on F\_Ports are automatically uninstalled.

If end-to-end monitors are present on the local switch, the command fails with the message:

```
Cannot install Fabric Mode Top Talker because EE monitor is already present
```

If end-to-end monitors are present on remote switches running Fabric OS 6.1.0 or later, the command succeeds; however, on the remote switches, fabric mode fails and a raslog message is displayed on those switches.

If end-to-end monitors are present on remote switches running Fabric OS 6.0.x, the command succeeds.

If a new switch joins the fabric, you must run the **perfttmon --add fabricmode** command on the new switch. The Top Talker configuration information is *not* automatically propagated to the new switch.

## Displaying the top *n* bandwidth-using flows on an F\_Port

1. Connect to the switch and log in as admin.
2. Enter the **perfttmon --show** command.

```
perfttmon --show [slotnumber/]port [n] [wnw | pid]
```

The output is sorted based on the data rate of each flow. If you do not specify the number of flows to display, then the command displays the top 8 flows or the total number of flows, whichever is less.

For example, to display the top 5 flows on port 7 in WWN (default) format:

```
perfttmon --show 7 5
```

To display the top flows on slot 2, port 4 on the Brocade 48000, Brocade DCX, or DCX-4S in PID format:

```
perfttmon --show 2/4 pid
```

```
switch:admin> perfttmon --show 2/4 pid
```

```
=====
Src_PID      Dst_PID      MB/sec
=====
0xa90800     0xa05200     6.926
0xa90800     0xa908ef     6.872
```

## Displaying top talking flows for a given domain ID (fabric mode)

1. Connect to the switch and log in as admin.
2. Enter the **perfttmon --show dom** command.

```
perfttmon --show dom domainid [n] [wwn | pid]
```

Fabric mode must be enabled for this option.

The output is sorted based on the data rate of each flow. If you do not specify the number of flows to display, then the command displays the top 8 flows or the total number of flows, whichever is less. The command can display a maximum of 32 flows.

For example, to display the top 5 flows on for domain 1 in WWN (default) format:

```
perfttmon --show dom 1 5
```

To display the top flows on domain 2 in PID format:

```
perfttmon --show dom 2 pid
```

### Example

```
switch:admin> perfttmon --show dom 2 pid
```

```
=====
Src_PID          Dst_PID          MB/sec          Potential E-Ports
=====
0x03f600         0x011300         121.748         2/0,2/2,2/3
0x03f600         0x011300         121.748         3/14,3/15
=====
```

## Deleting a Top Talker monitor on an F\_Port

1. Connect to the switch and log in as admin.
2. Enter the **perfttmon --delete** command.

```
perfttmon --delete [slotnumber/]port
```

For example, to delete the monitor on port 7:

```
perfttmon --delete 7
```

To delete the monitor on slot 2, port 4 on the Brocade 48000, Brocade DCX, or DCX-4S:

```
perfttmon --delete 2/4
```

## Deleting the fabric mode Top Talker monitors

1. Connect to the switch and log in as admin.
2. Enter the **perfttmon --delete fabricmode** command.

```
perfttmon --delete fabricmode
```

All Top Talker monitors are deleted.

## Limitations of Top Talker monitors

Be aware of the following when using Top Talker monitors:

- Top Talker monitors cannot detect transient surges in traffic through a given flow.
- You cannot install a Top Talker monitor on a mirrored port.
- Top Talker can monitor only 10,000 flows at a time.
- Top Talker is not supported on VE\_Ports, EX\_Ports, and VEX\_Ports.
- The maximum number of F\_Port Top Talker monitors on an ASIC is 16. If Virtual Fabrics is enabled, the maximum number of F\_Port Top Talker monitors on an ASIC is 8.

## Trunk monitoring

To monitor E\_Port (ISL) and F\_Port trunks, you can set monitors only on the master port of the trunk. If the master changes, the monitor automatically moves to the new master port.

If a monitor is installed on a port that later becomes a slave port when a trunk comes up, the monitor automatically moves to the master port of the trunk.

Note the following:

- End-to-end monitors are not supported for ISLs.
- For F\_Port trunks, end-to-end masks are allowed only on the F\_Port trunk master. Unlike the monitors, if the master changes, the mask does not automatically move to the new master port.
- Brocade 300 platforms support eight frame monitors for trunks.
- The Brocade 4100, 4900, 5000, 5100, 5300, 5410, 5424, 5450, 5480, 7500, 7500E, 7600, 7800, 8000, VA-40FC48000, Brocade Encryption Switch, Brocade DCX, and DCX-4S platforms support 12 frame monitors for trunks.
- For the Brocade 8000, trunk monitoring is supported only on the FC ports and not on the CEE ports.

## Displaying end-to-end and ISL monitor counters

You can use this procedure display the end-to-end or ISL monitors on a specified port. For end-to-end counters, you can display either the cumulative count of the traffic detected by the monitors or a snapshot of the traffic at specified intervals.

1. Connect to the switch and log in as admin.
2. Enter the **perfmonitorshow** command.

```
perfmonitorshow --class monitor_class [slotnumber/]portnumber [interval]
```

**Example of displaying an end-to-end monitor on a port at 10-second intervals**

```
switch:admin> perfMonitorShow --class EE 4/5 10
Showing EE monitors 4/5 10: Tx/Rx are # of bytes
      0          1          2          3          4
-----  -----  -----  -----  -----
Tx   Rx    Tx   Rx    Tx   Rx    Tx   Rx    Tx   Rx
=====  =====  =====  =====  =====
```

## 17 Clearing end-to-end and ISL monitor counters

```
0      0      0      0      0      0      0      0      0      0
53m  4.9m  53m  4.9m  53m  4.9m  53m  4.9m  53m  0
53m  4.4m  53m  4.4m  53m  4.4m  53m  4.4m  53m  0
53m  4.8m  53m  4.8m  53m  4.8m  53m  4.8m  53m  0
53m  4.6m  53m  4.6m  53m  4.6m  53m  4.6m  53m  0
53m  5.0m  53m  5.0m  53m  5.0m  53m  5.0m  53m  0
53m  4.5m  53m  4.5m  53m  4.5m  53m  4.5m  53m  0
```

### Example of displaying EE monitors on a port

```
switch:admin> perfMonitorShow --class EE 4/5
There are 7 end-to-end monitor(s) defined on port 53.
KEY      SID      DID      OWNER_APP TX_COUNT      RX_COUNT      OWNER_IP_ADDR
-----
0  0x58e0f  0x1182ef  TELNET    0x0000000000000000  0x0000000000000000  N/A
0  0x21300  0x21dda  TELNET    0x00000004d0ba9915  0x0000000067229e65  N/A
1  0x21300  0x21ddc  TELNET    0x00000004d0baa754  0x0000000067229e65  N/A
2  0x21300  0x21de0  TELNET    0x00000004d0bab3a5  0x0000000067229e87  N/A
3  0x21300  0x21de1  TELNET    0x00000004d0bac1e4  0x0000000067229e87  N/A
4  0x21300  0x21de2  TELNET    0x00000004d0bad086  0x0000000067229e87  N/A
5  0x11000  0x21fd6  WEB_TOOLS 0x00000004d0bade54  0x0000000067229e87  192.168.169.40
6  0x11000  0x21fe0  WEB_TOOLS 0x00000004d0baed41  0x0000000067229e98  192.168.169.40
```

### Example of displaying ISL monitor information on a port

```
switch:admin> perfMonitorShow --class ISL 1/1
Total transmit count for this ISL: 1462326
Number of destination domains monitored: 3
Number of ports in this ISL: 2
Domain 97:          110379          Domain 98:          13965
Domain 99:          1337982
```

## Clearing end-to-end and ISL monitor counters

You can use this procedure to clear statistics counters for end-to-end and ISL monitors.

1. Connect to the switch and log in as admin.
2. Enter the `perfmonitors` command, to display the monitor numbers on a specific port.

```
perfmonitors --class monitor_class [slotnumber/]portnumber
```

3. Enter the `perfmonitorclear` command.

```
perfmonitorclear --class monitor_class [slotnumber/]portnumber [monitorId]
```

The following example clears statistics counters for an end-to-end monitor:

```
switch:admin> perfMonitorClear --class EE 1/2 5
End-to-End monitor number 5 counters are cleared

switch:admin> perfMonitorClear --class EE 1/2
This will clear ALL EE monitors' counters on port 2, continue?
(yes, y, no, n): [no] y
```

The following example clears statistics counters for an ISL monitor:

```
switch:admin> perfMonitorClear --class ISL 1
This will clear ISL monitor on port 1, continue? (yes, y, no, n): [no] y
```

## Saving and restoring monitor configurations

To prevent the switch configuration flash from running out of memory, the number of monitors saved to flash memory is limited as follows:

- The total number of EE monitors per port is limited to 16.
- The total number of frame monitors per port is limited to 16.
- The total number of monitors per switch is limited to 512.

When there are more than 512 monitors in the system, monitors are saved to flash memory in the following order:

- The EE monitors for each port (from 0 to MAX\_PORT)
- The frame monitors for each port

EE monitors get preference saving to flash memory when the total number of monitors in a switch exceeds 512. If the total number of monitors per port or switch exceeds the limit, then you will receive an error message indicating the count has been exceeded and that some monitors have been discarded.

1. Connect to the switch and log in as admin.
2. Type one of the following commands, depending on the action you want to perform:
  - To save the current end-to-end and frame monitor configuration settings into nonvolatile memory, use the **perfCfgSave** command:

```
switch:admin> perfCfgsave
This will overwrite previously saved Performance Monitoring
settings in FLASH. Do you want to continue? (yes, y, no, n): [no] y
Please wait ...
Performance monitoring configuration saved in FLASH.
```

- To restore a saved monitor configuration, use the **perfCfgRestore** command. For example, to restore the original performance monitor configuration after making several changes:

```
switch:admin> perfCfgrestore
This will overwrite current Performance Monitoring settings in RAM. Do you
want to continue? (yes, y, no, n): [no] y
Please wait... Performance monitoring configuration restored from FLASH
ROM.
```

- To clear the previously saved performance monitoring configuration settings from nonvolatile memory, use the **perfCfgClear** command:

```
switch:admin> perfCfgclear
This will clear Performance Monitoring settings in FLASH. The RAM settings
won't change. Do you want to continue? (yes, y, no, n): [no] y
Please wait... Committing configuration...done.
Performance Monitoring configuration cleared from FLASH.
```

## Performance data collection

Data collected through Advanced Performance Monitoring is deleted when the switch is rebooted. Using the Data Center Fabric Manager (DCFM) Enterprise Edition, you can store performance data persistently. For details on this feature, see the *DCFM User's Manual (Enterprise Edition)*.

## 17 Performance data collection



# Optimizing Fabric Behavior

---

## In this chapter

- [Adaptive Networking overview](#) ..... 401
- [Ingress Rate Limiting](#) ..... 402
- [QoS: SID/DID traffic prioritization](#) ..... 403
- [QoS zones](#) ..... 406
- [Setting traffic prioritization](#) ..... 414
- [Setting traffic prioritization over FC routers](#) ..... 415
- [Disabling QoS](#) ..... 416
- [Bottleneck detection](#) ..... 416
- [Enabling bottleneck detection on a switch](#) ..... 419
- [Excluding a port from bottleneck detection](#) ..... 419
- [Displaying bottleneck detection configuration details](#) ..... 420
- [Changing bottleneck alert parameters](#) ..... 420
- [Displaying bottleneck statistics](#) ..... 422
- [Disabling bottleneck detection on a switch](#) ..... 423

## Adaptive Networking overview

Adaptive Networking is a suite of tools and capabilities that enable you to ensure optimized behavior in the SAN. Even under the worst congestion conditions, the Adaptive Networking features can maximize the fabric behavior and provide necessary bandwidth for high-priority, mission-critical applications and connections.

The Adaptive Networking suite includes the following features:

- **Bottleneck detection**  
The bottleneck detection feature identifies devices attached to the fabric that are slowing down traffic. Bottleneck detection does not require a license. See [“Bottleneck detection”](#) on page 416 for information about this feature.
- **Top Talkers**  
The Top Talkers feature provides real-time information about the top “n” bandwidth-consuming flows passing through a specific port in the network. Top Talkers requires an Advanced Performance Monitoring license. See [“Top Talker monitors”](#) on page 393 for more information about this feature.

- **Traffic Isolation Zoning**  
Traffic Isolation Zoning (TI zoning) allows you to control the flow of interswitch traffic by creating a dedicated path for traffic flowing from a specific set of source ports (F\_Ports). Traffic Isolation Zoning does not require a license. See [“Traffic Isolation Zoning”](#) on page 267 for more information about this feature.
- **Ingress Rate Limiting**  
Ingress rate limiting restricts the speed of traffic from a particular device to the switch port. Ingress rate limiting requires an Adaptive Networking license. See [“Ingress Rate Limiting”](#) on page 402 for more information about this feature.
- **QoS SID/DID Traffic Prioritization**  
SID/DID traffic prioritization allows you to categorize the traffic flow between a host and target has having a high or low priority. QoS SID/DID traffic prioritization requires an Adaptive Networking license for 8 Gbps platforms, but does not require a license for 4 Gbps platforms. See [“QoS: SID/DID traffic prioritization”](#) on page 403 for more information about this feature.

You can use the Adaptive Networking features together to optimize the performance of your fabric. For example, you can do the following:

- You can use Top Talkers to identify the SID/DID pairs that consume the most bandwidth and can then configure them with certain QoS attributes so they get proper priority.
- If the bottleneck detection feature detects a latency bottleneck, you can use TI zones or QoS SID/DID traffic prioritization to isolate latency device traffic from high priority application traffic.
- If the bottleneck detection feature detects ISL congestion, you can use ingress rate limiting to slow down low priority application traffic, if it is contributing to the congestion.

## Ingress Rate Limiting

Ingress rate limiting is a licensed feature that requires the Adaptive Networking license. Ingress rate limiting restricts the speed of traffic from a particular device to the switch port. Use ingress rate limiting for the following situations:

- To reduce existing congestion in the network or proactively avoid congestion.
- To enable you to offer flexible bandwidth limit services based on requirements.
- To enable more important devices to use the network bandwidth during specific services, such as network backup.

To limit the traffic, you set the maximum speed at which the traffic can flow through a particular F\_Port or FL\_Port. For example, if you set the rate limit at 4 Gbps, then traffic from a particular device is limited to a maximum of 4 Gbps.

Ingress rate limiting enforcement is needed only if the port can run at a speed higher than the rate limit. For example, if the rate limit is 4 Gbps and the port is only a 2 Gbps port, then ingress rate limiting is not enforced.

The ingress rate limiting configuration is persistent across reboots.

Note the following considerations about ingress rate limiting:

- Ingress rate limiting is applicable only to F\_Ports and FL\_Ports.

- Ingress rate limiting is available only on the following platforms: Brocade 300, 5100, 5300, 5410, 5424, 5450, 5460, 5470, 5480, 7800, 8000, VA-40FC, Brocade Encryption Switch, Brocade DCX, or DCX-4S.
- QoS traffic prioritization takes precedence over ingress rate limiting.
- Ingress rate limiting is not enforced on trunked ports.

**Virtual Fabrics considerations:** If Virtual Fabrics is enabled, the rate limit configuration on a port is on a per-logical switch basis. That is, if a port is configured to have a certain rate limit value, and the port is then moved to a different logical switch, it would have no rate limit applied to it in the new logical switch. If that same port is moved back to the original logical switch, it would have the original rate limit take effect again.

## Limiting traffic from a particular device

1. Connect to the switch and log in as admin.
2. Enter the `portCfgQos --setratelimit` command.

```
portcfgqos --setratelimit slot/port ratelimit
```

Example of setting the rate limit on slot 3, port 9 to 4000 Mbps

```
portcfgqos --setratelimit 3/9 4000
```

## Disabling ingress rate limiting

1. Connect to the switch and log in as admin.
2. Enter the `portCfgQos --resetratelimit` command.

```
portcfgqos --resetratelimit slot/port
```

Example of disabling ingress rate limiting on slot 3, port 9

```
portcfgqos --resetratelimit 3/9
```

# QoS: SID/DID traffic prioritization

SID/DID traffic prioritization allows you to categorize the traffic flow between a host and target as having a high or low priority. For example, you could assign online transaction processing (OLTP) to high priority and backup traffic to low priority.

All flows without QoS prioritization are considered medium priority.

High, medium, and low priority flows are allocated to different virtual channels (VCs). High priority flows receive more VCs than medium priority flows, which receive more VCs than low priority flows. The virtual channels are allocated as shown in [Table 85](#).

**TABLE 85** Virtual channels assigned to QoS priority

Priority	Number of VCs	VCs assigned
High priority	5	10, 11, 12, 13, 14
Medium priority	4	2, 3, 4, 5
Low priority	2	8, 9

---

**NOTE**

If there is a single low priority flow to a destination ID (DID) and several medium priority flows to that same DID, then it is possible that the medium priority flows would have less bandwidth because they have to share the medium priority VCs, whereas the low priority flow would have a separate VC.

---

## License requirements for traffic prioritization

License requirements are different for 4 Gbps and 8 Gbps platforms:

- 4 Gbps platforms

Do *not* require a license: Brocade 4100, 4900, 5000, 7500, 7500E, 7600, and 48000.

You must manually enable QoS on 4 Gbps ports.

- 8 Gbps platforms

SID/DID traffic prioritization is a licensed feature for the 8 Gbps platforms: Brocade 300, 5100, 5300, 5410, 5424, 5450, 5460, 5470, 5480, 7800, 8000, VA-40FC, DCX, DCX-4S, and Brocade Encryption Switch.

An Adaptive Networking license must be installed on every 8 Gbps switch that is in the path between a configured device pair.

When you install the Adaptive Networking license, QoS is automatically enabled on 8 Gbps ports, except for long-distance 8 Gbps ports. For long-distance 8 Gbps ports, you must manually enable QoS after you install the license.

### *Trunking considerations before you install the Adaptive Networking license*

This section applies only to 8 Gbps ports that are not long-distance ports.

If 8 Gbps ports are part of an active trunk group before the Adaptive Networking license is added, ISLs are formed without QoS.

When you install the Adaptive Networking license, QoS is automatically enabled on all 8 Gbps ports for which you have not manually disabled QoS, so the 8 Gbps ports in the trunk group are set to QoS enabled by default.

Adding the license does not immediately affect the trunk groups. The trunks continue without QoS until the next time one of the ISLs is toggled, at which point the toggled ISL comes up with QoS enabled and splits from the trunk group because of a QoS mismatch.

To preserve existing trunk groups, before you install the Adaptive Networking license, manually disable QoS on these 8 Gbps ports.

### *Manually disabling QoS on 8 Gbps ports*

---

**NOTE**

QoS is disabled by default on 4 Gbps ports and long-distance 8 Gbps ports. The following procedure does not apply to these ports.

---

1. Connect to the switch and log in as admin.
2. Display the ISL information using the following command:

```
islshow
```

3. Identify E\_Ports on which QoS should be manually disabled. In the **islshow** output, these ports have all of the following characteristics:
  - 8 Gbps ports
  - Trunking is enabled
  - QoS is disabled
4. Check whether QoS is enabled on each port identified in [step 3](#) using the following command:

```
portcfgshow
```

In the output, the value of **QOS E\_Port** is **AE** if QoS is automatically enabled by default, **ON** if QoS is enabled manually, and **OFF** or "." if QoS is disabled.

5. Manually disable QoS on all of the ports identified in [step 3](#) for which QoS is enabled (in the **portcfgshow** output, **QOS E\_Port** is **AE** or **ON**).

```
portcfgqos --disable [slot/]port
```

This is a nondisruptive operation.

**Example**

In this example, the **islshow** output displays ports involved in four ISLs:

- Port 2                    QoS is enabled on this ISL, so you should not disable QoS on port 2.
- Port 8                    QoS is disabled on this ISL; however, this is a 4 Gbps port, so you do not need to disable QoS on port 8.
- Ports 19 and 24        QoS is disabled on these ISLs. Check the **portcfgshow** output to determine whether QoS is disabled on these ports.

In the **portcfgshow** output, the value of **QOS\_E\_Port** is **AE** for port 19 and "." for port 24. This means that QoS is enabled by default on port 19 and disabled on port 24.

You need to disable QoS on port 19.

```
switch:admin> islshow
1: 2->300 10:00:00:05:1e:43:00:00 100 DCX sp: 8.000G bw: 32.000G TRUNK QOS
2: 8-> 3 10:00:00:05:1e:41:8a:d5 30 B5300 sp: 4.000G bw: 16.000G TRUNK
3: 19-> 10 10:00:00:05:1e:41:43:ac 50 B300 sp: 8.000G bw: 64.000G TRUNK
4: 24-> 12 10:00:00:05:1e:41:42:ad 30 B5300 sp: 8.000G bw: 16.000G TRUNK
```

```
switch:admin> portcfgshow
```

(output truncated)

Ports of Slot	0	16	17	18	19	20	21	22	23	24	25	26	27	28	29	30	31
Speed	AN	AN	AN	AN	AN	AN	AN	AN	AN	AN	AN	AN	AN	AN	AN	AN	AN
Fill Word	0	0	0	0	0	0	0	0	0	0	0	0	0	0	0	0	0
AL_PA Offset 13	..	..	..	..	..	..	..	..	..	..	..	..	..	..	..	..	..
Trunk Port	ON	ON	ON	ON	ON	ON	ON	ON	ON	ON	ON	ON	ON	ON	ON	ON	ON
Long Distance	..	..	..	..	..	..	..	..	..	..	..	..	..	..	..	..	..
VC Link Init	..	..	..	..	..	..	..	..	..	..	..	..	..	..	..	..	..
Locked L_Port	..	..	..	..	..	..	..	..	..	..	..	..	..	..	..	..	..
Locked G_Port	..	..	..	..	..	..	..	..	..	..	..	..	..	..	..	..	..
Disabled E_Port	..	..	..	..	..	..	..	..	..	..	..	..	..	..	..	..	..
Locked E_Port	..	..	..	..	..	..	..	..	..	..	..	..	..	..	..	..	..
ISL_R_RDY Mode	..	..	..	..	..	..	..	..	..	..	..	..	..	..	..	..	..

## 18 QoS zones

RSCN Suppressed	..	..	..	..	..	..	..	..	..	..	..	..	..	..	..	..
Persistent Disable	ON	..	..	..	..	..	..	..	..	..	..	..	..	..	..	..
LOS TOV enable	..	..	..	..	..	..	..	..	..	..	..	..	..	..	..	..
NPIV capability	ON	ON	ON	ON	ON	ON	ON	ON	ON	ON	ON	ON	ON	ON	ON	ON
NPIV PP Limit	126	126	126	126	126	126	126	126	126	126	126	126	126	126	126	126
QOS E_Port	AE	AE	AE	AE	AE	AE	AE	AE	..	..	..	..	..	..	..	..
EX Port	..	..	..	..	..	..	..	..	..	..	..	..	..	..	..	..
Mirror Port	ON	..	..	..	ON	..	..	..	..	..	..	..	..	..	..	..
Rate Limit	..	..	..	..	..	..	..	..	..	..	..	..	..	..	..	..
Credit Recovery	ON	ON	ON	ON	ON	ON	ON	ON	ON	ON	ON	ON	ON	ON	ON	ON
Fport Buffers	..	..	..	..	..	..	..	..	..	..	..	..	..	..	..	..
Port Auto Disable	..	..	..	..	..	..	..	..	..	..	..	..	..	..	..	..
CSCTL mode	..	..	..	..	..	..	..	..	..	..	..	..	..	..	..	..

where AE:QoSAutoEnable, AN:AutoNegotiate, ..:OFF, NA:NotApplicable, ?:INVALID,

```
switch:admin> portcfgqos --disable 19
```

## QoS zones

You assign high or low priority (QoS level) using a QoS zone. A QoS zone is a special zone that indicates the priority of the traffic flow between a given host/target pair.

The members of a QoS zone are the host/target pairs. QoS zones can contain WWN members (WWNN or WWPN) or *Domain, Index (D,I)* members. If you use D,I notation in your QoS zones, see [“Limitations and restrictions for traffic prioritization”](#) on page 413 for some considerations you should be aware of.

A QoS zone has a special name to differentiate it from a regular zone. The format of the QoS zone name is as follows:

For high priority: QOSH $id$ \_xxxxx  
For low priority: QOSL $id$ \_xxxxx

where  $id$  is a flow identifier that designates a specific virtual channel for the traffic flow and xxxxx is the user-defined portion of the name. For example, the following are valid QoS zone names:

QOSH3\_HighPriorityTraffic  
QOSL1\_LowPriorityZone

The switch automatically sets the priority for the “host,target” pairs specified in the zones based on the priority level (H or L) in the zone name.

The flow  $id$  allows you to have control over the VC assignment and control over balancing the flows throughout the fabric. The  $id$  is from 1–5 for high priority traffic, which corresponds to VCs 10–14. For low priority traffic, the  $id$  is from 1–2, which corresponds to VCs 8 and 9. The  $id$  is optional; if it is not specified, the virtual channels are allocated using a round-robin scheme.

---

### NOTE

If a QoS zone name prefix is specified in an LSAN zone (a zone beginning with prefix "LSAN\_"), the QoS tag is ignored. Only the first prefix in a zone name is recognized. For example, a zone with the name "LSAN\_QOSH\_zone1" is recognized as an LSAN zone and not a QoS zone.

See [“QoS over FC routers”](#) on page 408 for additional considerations when using QoS to prioritize traffic between device pairs in different edge fabrics.

---

For example, [Figure 61](#) shows a fabric with two hosts (H1, H2) and three targets (S1, S2, S3). The traffic prioritization is as follows:

- Traffic between H1 and S1 is high priority.
- Traffic between H1 and S3 and between H2 and S3 is low priority.
- All other traffic is medium priority, which is the default.

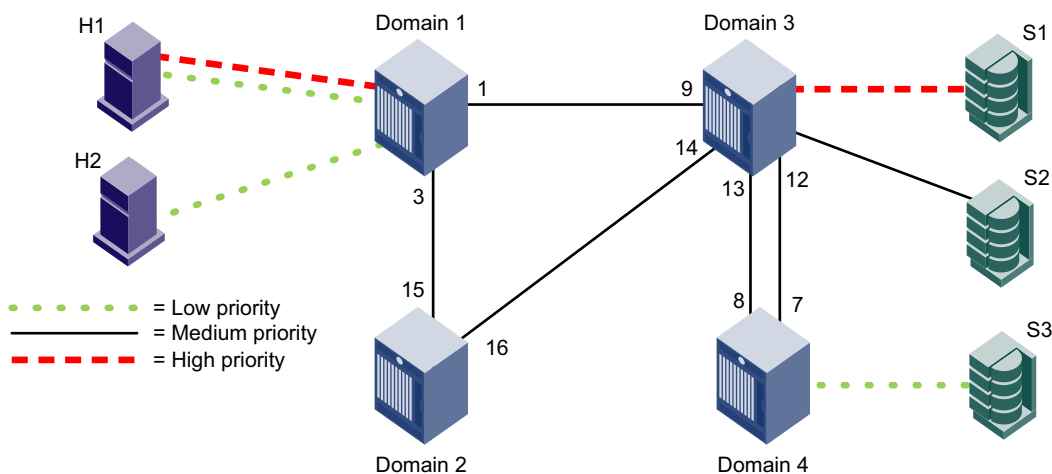

**FIGURE 61** QoS traffic prioritization

For this fabric, you could set up the following QoS zones:

- QOSH\_Zone1 Members: H1, S1
- QOSL\_Zone3 Members: H1, H2, S3

## QoS on E\_Ports

In addition to configuring the hosts and targets in a zone, you must also enable QoS on individual E\_Ports that might carry traffic between the host and target pairs. Path selection between the “host,target” pairs is governed by FSPF rules and is not affected by QoS priorities. For example, in [Figure 62](#), QoS should be enabled on the encircled E\_Ports.

---

### NOTE

By default, QoS is enabled on 8 Gbps ports, except for long-distance 8 Gbps ports. QoS is disabled by default on all 4 Gbps ports and long-distance 8 Gbps ports.

---

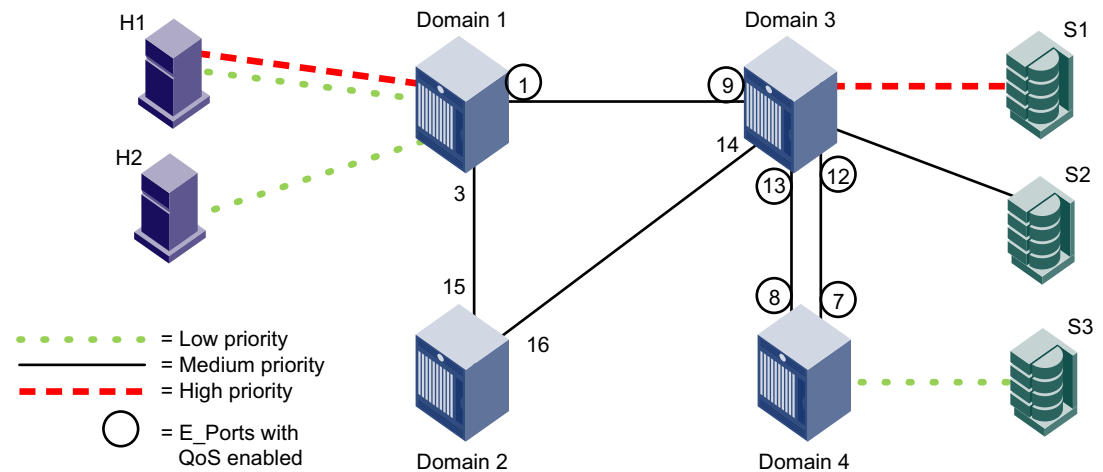

**FIGURE 62** QoS with E\_Ports enabled

You need to enable QoS on the E\_Ports on both ISLs between Domain 3 and Domain 4 because either path might be selected to carry the traffic.

You do *not* need to enable QoS on the E\_Ports on the ISLs between Domain 1 and Domain 2 and between Domain 2 and Domain 3, because these are not the shortest paths between the hosts and the targets. However, if the ISL between Domain 1 and Domain 3 is broken, then the path through Domain 2 would be used.

To guarantee traffic priority, you should enable QoS on all possible E\_Ports. Alternatively, you could use a TI zone to limit the E\_Ports that carry the traffic between a “host,target” pair and enable QoS on only those E\_Ports.

If QoS is not enabled on an E\_Port, the traffic prioritization stops at that point. For example, in [Figure 62](#) if you disabled QoS on E\_Ports “3,12” and “3,13” then the traffic from H1 and H2 to S3 would be low priority from the hosts to Domain 3, but would switch to the default (medium) priority from Domain 3 to the target S3.

## QoS over FC routers

QoS over FCR is QoS traffic prioritization between devices in edge fabrics over an FC router. See [Chapter 21, “Using the FC-FC Routing Service,”](#) for information about FC routers, phantom switches, and the FC-FC Routing Service.

To establish QoS over FC routers, you must do the following:

- Define QoS zones in each edge fabric.
- Define LSAN zones in each edge fabric.
- Enable QoS on the E\_Ports (or VE\_Ports) in each edge fabric.
- Enable QoS on the EX\_Ports (or VEX\_Ports) in the backbone fabric.

See [“Setting traffic prioritization over FC routers”](#) on page 415 for detailed instructions.

Following are requirements for establishing QoS over FCR:

- QoS over FC routers is supported in Brocade native mode only. It is not supported in interopmode 2 or interopmode 3.



- QoS over FC routers is supported only in an edge-to-edge fabric configuration; it is not supported in a backbone-to-edge fabric configuration. You cannot prioritize the flow between a device in an edge fabric and a device in the backbone fabric.
- QoS over FC routers is supported only if Virtual Fabrics is disabled in the backbone fabric. QoS over FC routers cannot be enabled if Virtual Fabrics is also enabled in the backbone fabric.
- The port WWN of the host or target and the port WWN of the proxy device must be in both an LSAN zone and a QoS zone.
- QoS over FC routers is supported on both EX\_Ports and VEX\_Ports. QoS over FC routers is not supported on the FR4-18i blade.
- The EX\_Ports (or VEX\_Ports) in the path between the QoS devices must be on switches running Fabric OS v6.3.0 or later.
- QoS zones must use WWN notation only; D,I notation is not supported for QoS over FCR.
- An Adaptive Networking license must be installed on every switch that is in the path between a given configured device pair, including the switches in the backbone fabric and both edge fabrics.

### Virtual Fabric considerations for traffic prioritization

You can prioritize flows between devices in a logical fabric. The priority is retained for traffic going across ISLs and through the base fabric XISLs.

For example, [Figure 63](#) shows a logical fabric that includes H1 and S1. To set the traffic between H1 and S1 to high priority, create a QoS zone in the logical fabric with H1 and S1 as members. Then enable QoS on all of the E\_Ports shown circled in the figure, including all of the E\_Ports in the XISLs (ports 10, 11, 12, 13, 14, 15, 16, and 17).

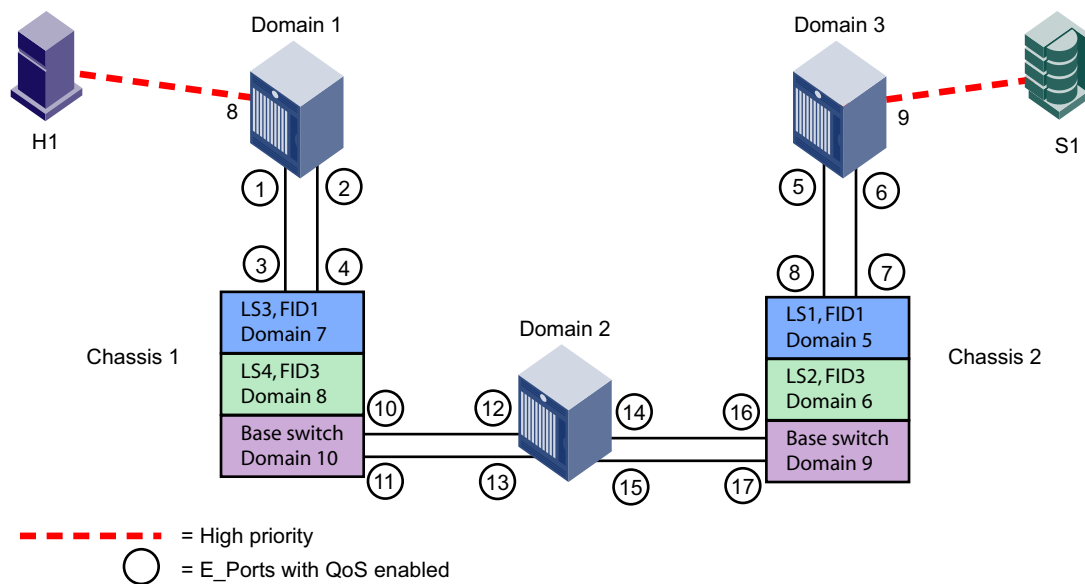

**FIGURE 63** Traffic prioritization in a logical fabric

## High availability considerations for traffic prioritization

If the standby CP is running a Fabric OS version earlier than 6.3.0 and is synchronized with the active CP, then QoS zones using D,I notation cannot be created. If the standby CP is not synchronized or if no standby CP exists, then the QoS zone creation succeeds.

If QoS zones using D,I notation exist in either the defined or active configuration and the standby CP tries to synchronize with the active CP, the synchronization fails if the standby CP is running a Fabric OS version earlier than 6.3.0. Synchronization can succeed only if the QoS D,I zones are removed.

## Supported configurations for traffic prioritization

Note the following configuration rules for traffic prioritization:

- All switches in the fabric must be running Fabric OS v6.0.0 or later.

---

### ATTENTION

If QoS traffic crosses an ISL for a switch running a firmware version earlier than Fabric OS v6.0.0, the frames are dropped.

---

- By default, all devices are assigned medium priority.
  - To be assigned high or low priority, hosts and targets must be connected to one of the following:
    - Brocade 300
    - Brocade 5100
    - Brocade 5300
    - Brocade 5410
    - Brocade 5424
    - Brocade 5450
    - Brocade 5460
    - Brocade 5470
    - Brocade 5480
    - Brocade 7800
    - Brocade 8000
    - Brocade VA-40FC
    - FC8-16, FC8-32, or FC8-48 port blade in the Brocade DCX or DCX-4S platform.
  - To preserve the priority level across ISLs, the switches must be running Fabric OS v6.0.0 or later and must be one of the following platforms: Brocade 300, 4100, 4900, 5000, 5100, 5300, 5410, 5424, 5450, 5480, 7500, 7500E, 7600, 7800, 8000, VA-40FC, 48000, Brocade DCX, or DCX-4S.
- QoS is enabled by default on 8 Gbps ports. QoS is disabled by default on all 4 Gbps ports and long-distance 8 Gbps ports.

## Upgrade considerations for traffic prioritization

This section applies only to 4 Gbps ports and long-distance 8 Gbps ports.

QoS is disabled by default on 4 Gbps ports and long-distance 8 Gbps ports. In some firmware versions earlier than Fabric OS 6.3.0, QoS is *enabled* by default on these ports.

When you upgrade to Fabric OS 6.3.0, the QoS configuration settings remain the same for all ports (that is, if a port was enabled for QoS before the upgrade, it remains enabled for QoS after the upgrade).

For 4 Gbps and long-distance 8 Gbps ports, if QoS is enabled by default and QoS is in use prior to the upgrade, QoS is temporarily enabled on these ports after the upgrade. If these ports are subsequently toggled, the QoS setting is reset to the default setting (QoS disabled). If these ports are part of a trunk group, this can cause the trunk group to split because the toggled ports come online with QoS enabled while the remaining ports in the trunk group have QoS disabled.

To prevent the QoS setting from being changed when the port is toggled, after you upgrade to v6.3.0 or later you must manually enable QoS on the 4 Gbps ports and long-distance 8 Gbps ports on which QoS was enabled by default prior to the upgrade.

---

#### NOTE

If you already manually enabled QoS on these ports before the upgrade, you do not have to manually enable them again after the upgrade.

---

### *Manually enabling QoS on 4 Gbps ports and long-distance 8 Gbps ports after upgrade*

1. Connect to the switch and log in as admin.
2. Display the ISL information using the following command:

```
islshow
```

3. Identify E\_Ports on which QoS should be manually enabled. In the **islshow** output, these ports have all of the following characteristics:
  - 4 Gbps or 8 Gbps ports
  - QoS is enabled
4. Check whether QoS is enabled on each port identified in [step 3](#) using the following command:

```
portcfgshow
```

In the output, the value of **QOS E\_Port** is **AE** if QoS is automatically enabled by default and **ON** if QoS is enabled manually.

5. For 8 Gbps ports, check whether they are long-distance ports (in the **portcfgshow** output, **Long Distance** is **ON**).
6. Manually enable QoS on all of the ports identified in [step 3](#) for which QoS is automatically enabled (in the **portcfgshow** output, **QOS E\_Port** is **AE**).

```
portcfgqos --enable [slot/]port
```

If the port is an 8 Gbps port, you do not need to enable QoS unless the port is also a long-distance port (in the **portcfgshow** output, **Long Distance** is **ON**).

This is a non-disruptive operation.

## Example

In this example, the **islshow** output displays ports involved in four ISLs:

- Ports 2 and 8 QoS is enabled on these ISLs. Check the **portcfgshow** output to determine whether QoS is disabled on these ports.
- Port 19 QoS is enabled on this ISL. Because this is an 8 Gbps port, check the **portcfgshow** output to determine whether this is a long distance port and whether QoS is disabled on this port.
- Port 24 QoS is disabled on this ISL, so you should not enable QoS on port 24.

In the **portcfgshow** output, the value of **QOS\_E\_Port** is **AE** for ports 2 and 19 and **ON** for port 8. This means that QoS is enabled by default on ports 2 and 19 and enabled manually on port 8.

Port 19 is an 8 Gbps port, so you do not need to enable QoS unless this is also a long-distance port. The **portcfgshow** output indicates that port 19 is a long-distance port (**Long Distance** is **ON**).

You need to manually enable QoS on ports 2 and 19.

```
switch:admin> islshow
1: 2->300 10:00:00:05:1e:43:00:00 100 DCX sp: 4.000G bw: 32.000G TRUNK QOS
2: 8-> 3 10:00:00:05:1e:41:8a:d5 30 B5300 sp: 4.000G bw: 16.000G TRUNK QOS
3: 19-> 10 10:00:00:05:1e:41:43:ac 50 B300 sp: 8.000G bw: 64.000G TRUNK QOS
4: 24-> 12 10:00:00:05:1e:41:42:ad 30 B5300 sp: 4.000G bw: 16.000G TRUNK

switch:admin> portcfgshow
Ports of Slot 0 0 1 2 3 4 5 6 7 8 9 10 11 12 13 14 15
-----+-----+-----+-----+-----+-----+-----+-----+-----+-----+-----+-----+-----+-----+-----+-----+-----+
Speed AN AN AN 8G 8G 8G AN AN AN AN AN 8G 8G 8G AN AN AN
Fill Word 0 1 0 0 0 0 0 0 0 0 0 0 0 0 0 0
AL_PA Offset 13 .. .. .. .. .. .. .. .. .. .. .. .. .. .. .. ..
Trunk Port ON ON ON ON ON ON ON ON ON ON ON ON ON ON ON ON ON
Long Distance .. .. .. .. .. .. .. .. .. .. .. .. .. .. .. ..
VC Link Init .. .. .. .. .. .. .. .. .. .. .. .. .. .. .. ..
Locked L_Port .. .. .. .. .. .. .. .. .. .. .. .. .. .. .. ..
Locked G_Port .. .. .. .. .. .. .. .. .. .. .. .. .. .. .. ..
Disabled E_Port .. .. .. .. .. .. .. .. .. .. .. .. .. .. .. ..
Locked E_Port .. .. .. .. .. .. .. .. .. .. .. .. .. .. .. ..
ISL R_RDY Mode .. .. .. .. .. .. .. .. .. .. .. .. .. .. .. ..
RSCN Suppressed .. .. .. .. .. .. .. .. .. .. .. .. .. .. .. ..
Persistent Disable .. .. .. .. .. .. .. .. .. .. .. .. ON ON .. ON .. ..
LOS TOV enable .. .. .. ON .. .. .. .. .. .. .. .. .. .. .. .. ..
NPIV capability ON ON ON ON ON ON ON ON ON ON ON ON ON ON ON ON ON
NPIV PP Limit 126 176 126 126 126 126 126 126 126 126 126 126 126 126 126 126
QOS E_Port .. .. AE AE AE AE AE AE ON ON ON ON ON ON ON ON ON
EX Port .. .. .. .. .. .. .. .. .. .. .. .. .. .. .. ..
Mirror Port .. .. .. .. ON .. .. .. .. .. .. .. .. .. .. ..
Rate Limit .. .. .. .. .. .. .. .. .. .. .. .. .. .. .. ..
Credit Recovery ON ON ON ON ON ON ON ON ON ON ON ON ON ON ON ON
Fport Buffers .. .. .. ON .. .. .. .. .. .. .. .. ON .. .. .. ..
Port Auto Disable .. .. .. .. .. .. .. .. .. .. .. .. .. .. .. ..
CSCTL mode .. .. .. .. .. .. .. .. .. .. .. .. .. .. .. ..

Ports of Slot 0 16 17 18 19 20 21 22 23 24 25 26 27 28 29 30 31
-----+-----+-----+-----+-----+-----+-----+-----+-----+-----+-----+-----+-----+-----+-----+-----+
Speed AN AN AN AN AN AN AN AN AN AN AN AN AN AN AN AN AN
Fill Word 0 0 0 0 0 0 0 0 0 0 0 0 0 0 0 0
AL_PA Offset 13 .. .. .. .. .. .. .. .. .. .. .. .. .. .. .. ..
```

Trunk Port	ON	ON	ON	ON	ON	ON	ON	ON	ON	ON	ON	ON	ON	ON	ON	ON
Long Distance	ON	ON	ON	ON	ON	ON	ON	ON	..	..	..	..	..	..	..	..
VC Link Init	..	..	..	..	..	..	..	..	..	..	..	..	..	..	..	..
Locked L_Port	..	..	..	..	..	..	..	..	..	..	..	..	..	..	..	..
Locked G_Port	..	..	..	..	..	..	..	..	..	..	..	..	..	..	..	..
Disabled E_Port	..	..	..	..	..	..	..	..	..	..	..	..	..	..	..	..
Locked E_Port	..	..	..	..	..	..	..	..	..	..	..	..	..	..	..	..
ISL R_RDY Mode	..	..	..	..	..	..	..	..	..	..	..	..	..	..	..	..
RSCN Suppressed	..	..	..	..	..	..	..	..	..	..	..	..	..	..	..	..
Persistent Disable	ON	..	..	..	..	..	..	..	..	..	..	..	..	..	..	..
LOS TOV enable	..	..	..	..	..	..	..	..	..	..	..	..	..	..	..	..
NPIV capability	ON	ON	ON	ON	ON	ON	ON	ON	ON	ON	ON	ON	ON	ON	ON	ON
NPIV PP Limit	126	126	126	126	126	126	126	126	126	126	126	126	126	126	126	126
QOS E_Port	AE	AE	AE	AE	AE	AE	AE	AE	..	..	..	..	..	..	..	..
EX Port	..	..	..	..	..	..	..	..	..	..	..	..	..	..	..	..
Mirror Port	ON	..	..	..	ON	..	..	..	..	..	..	..	..	..	..	..
Rate Limit	..	..	..	..	..	..	..	..	..	..	..	..	..	..	..	..
Credit Recovery	ON	ON	ON	ON	ON	ON	ON	ON	ON	ON	ON	ON	ON	ON	ON	ON
Fport Buffers	..	..	..	..	..	..	..	..	..	..	..	..	..	..	..	..
Port Auto Disable	..	..	..	..	..	..	..	..	..	..	..	..	..	..	..	..
CSCTL mode	..	..	..	..	..	..	..	..	..	..	..	..	..	..	..	..

where AE:QoSAutoEnable, AN:AutoNegotiate, ..:OFF, NA:NotApplicable, ?:INVALID,

```
switch:admin> portcfgqos --enable 2
switch:admin> portcfgqos --enable 19
```

## Limitations and restrictions for traffic prioritization

Note the following configuration rules for traffic prioritization:

- If a host and target are included in two or more QoS zones with different priorities, the zone with the lowest priority takes precedence. For example, if an effective zone configuration has QOSH\_z1 (H,T) and QOSL\_z2 (H,T), the traffic flow between H and T will be of low QoS priority. Additionally, if QOSH\_z1 (H,T) overlaps with a “domain,port” zone at the H port, the traffic flow between H and T is dropped to medium priority and the H port is marked as a session-based zoning port.
- Traffic prioritization is enforced on the egress ports only, not on the ingress ports.
- Traffic prioritization is not supported on 10 Gbps ISLs.
- Traffic prioritization is not supported on mirrored ports.
- Traffic prioritization is not supported over LSAN zones. The traffic is always medium priority in the ingress edge fabric, the backbone fabric, and the egress edge fabric.
- Traffic prioritization is not supported on a CryptoTarget container (redirection zone). See the *Fabric OS Encryption Administrator’s Guide* for information about redirection zones.
- Traffic prioritization is not supported in McDATA Fabric Mode (interopmode 2) or Open Fabric Mode (interopmode 3).
- You must be running Fabric OS v6.3.0 or later to create QoS zones using D,I notation.
- QoS zones using D,I notation are not supported for QoS over FCR.
- QoS zones using D,I notation should not be used for loop or NPIV ports.

- If QoS is enabled, an additional 16 buffer credits are allocated per port for 8-Gbps ports in LE mode. See [Chapter 20, “Managing Long Distance Fabrics,”](#) for information about buffer credit allocation in extended fabrics.
- **Trunking considerations:** If some ports in a trunk group have QoS enabled and some ports have QoS disabled, then two different trunks are formed, one with QoS enabled and one with QoS disabled.

## Setting traffic prioritization

1. Connect to the switch and log in as admin.
2. Enter the **zoneCreate** command to create zones for high and low priority traffic.
  - For high priority traffic, use the following syntax:  

```
zonecreate "QOSHid_zonename", "member[; member...]"
```
  - For low priority traffic, use the following syntax:  

```
zonecreate "QOSLid_zonename", "member[; member...]"
```

The *id* is from 1–5 for high priority traffic, which corresponds to VCs 10–14. For low priority traffic, the *id* is from 1–2, which corresponds to VCs 8 and 9. The *id* is optional; if it is not specified, the virtual channels are allocated using a round-robin scheme.
3. Enter the **cfgAdd** command to add the QoS zone to the zone configuration, using the following syntax:

```
cfgadd "cfgname", "QOSzonename"
```

4. Enter the **cfgSave** command to save the change to the defined configuration.
5. Enter the **cfgEnable** command for the appropriate zone configuration to make the change effective.

```
cfgenable "cfgname"
```

6. Enter the **portCfgQos** command to enable QoS on the E\_Ports, using the following syntax:

```
portcfgqos --enable [slot/]port
```

The **portCfgQos** command does not affect QoS prioritization. It only enables or disables the link to pass QoS priority traffic.

---

### NOTE

For the Brocade 300, 5100, 5300, 5410, 5424, 5450, 5460, 5470, 5480, 7800, 8000, VA-40FC, Brocade Encryption Switch, and the Brocade DCX and DCX-4S enterprise-class platform, QoS is enabled by default on all ports. If you use the **portCfgQos** command to enable QoS on a specific port, the port is toggled to apply this configuration, even though the port already has QoS enabled. The port is toggled because the user configuration changed, even though the actual configuration of the port did not change.

If you later use the **portCfgQos** command to enable QoS on the port again, the port is *not* toggled because the configuration did not change.

---

**Example**

```

sw0:admin> zonecreate "QOSH1_zone", "10:00:00:00:10:00:00:00;
10:00:00:00:20:00:00:00"
sw0:admin> zonecreate "QOSL2_zone", "10:00:00:00:30:00:00:00;
10:00:00:00:40:00:00:00"
sw0:admin> zoneshow
sw0:admin> cfgadd "cfg1", "QOSH1_zone"
sw0:admin> cfgadd "cfg1", "QOSL2_zone"
sw0:admin> cfgshow
Defined configuration:
  cfg:  cfg1    zone1; QOSH1_zone; QOSL2_zone
  zone:  QOSH1_zone
         10:00:00:00:10:00:00:00; 10:00:00:00:20:00:00:00
  zone:  QOSL2_zone
         10:00:00:00:30:00:00:00; 10:00:00:00:40:00:00:00
  zone:  zone1  10:00:00:00:10:00:00:00; 10:00:00:00:20:00:00:00;
         10:00:00:00:30:00:00:00; 10:00:00:00:40:00:00:00

Effective configuration:
No Effective configuration: (No Access)

sw0:admin> cfigsave
You are about to save the Defined zoning configuration. This
action will only save the changes on Defined configuration.
Any changes made on the Effective configuration will not
take effect until it is re-enabled.
Do you want to save Defined zoning configuration only? (yes, y, no, n): [no] y
Updating flash ...
sw0:admin> cfgenable "cfg1"
You are about to enable a new zoning configuration.
This action will replace the old zoning configuration with the
current configuration selected. If the update includes changes
to one or more traffic isolation zones, the update may result in
localized disruption to traffic on ports associated with
the traffic isolation zone changes
Do you want to enable 'cfg1' configuration (yes, y, no, n): [no] y
zone config "cfg1" is in effect
Updating flash ...
sw0:admin> portcfgqos --enable 3

```

## Setting traffic prioritization over FC routers

1. Connect to the switch in the edge fabric and log in as admin.
2. Create QoS zones in the edge fabric.  
The QoS zones must have WWN members only, and not D,I members. See [“Setting traffic prioritization”](#) on page 414 for instructions.
3. Create LSAN zones in the edge fabric.  
See [“Controlling device communication with the LSAN”](#) on page 478 for instructions.
4. Enter the **portCfgQos** command to enable QoS on the E\_Ports (or VE\_Ports).
5. Repeat [step 1](#) through [step 3](#) to create QoS zones and LSAN zones on the other edge fabric.
6. Connect to the FC router in the backbone fabric and log in as admin.
7. Enter the **portCfgQos** command to enable QoS on the EX\_Ports (or VEX\_Ports).

## Disabling QoS

1. Connect to the switch and log in as admin.
2. Enter the **cfgRemove** command to remove the QoS zones from the current zone configuration.
3. Enter the **portCfgQoS** command to disable QoS on the E\_Ports.

## Bottleneck detection

Bottleneck detection does not require a license.

A *bottleneck* is a port in the fabric where frames cannot get through as fast as they should. In other words, a bottleneck is a port where the offered load is greater than the achieved egress throughput. Bottlenecks can cause undesirable degradation in throughput on various links. When a bottleneck occurs at one place, other points in the fabric can experience bottlenecks as the traffic backs up.

The bottleneck detection feature detects two types of bottlenecks:

- Latency bottleneck
- Congestion bottleneck

A *latency bottleneck* is a port where the offered load exceeds the rate at which the other end of the link can continuously accept traffic, but does not exceed the physical capacity of the link. This condition can be caused by a device attached to the fabric that is slow to process received frames and send back credit returns. A latency bottleneck due to such a device can spread through the fabric and can slow down unrelated flows that share links with the slow flow.

A *congestion bottleneck* is a port that is unable to transmit frames at the offered rate because the offered rate is greater than the physical data rate of the line. For example, this condition can be caused by trying to transfer data at 8 Gbps over a 4 Gbps ISL.

The bottleneck detection feature detects latency and congestion bottlenecks and reports the bottlenecks through RASlog alerts and SNMP traps. You can set alert thresholds for the severity and duration of the bottleneck.

If a bottleneck is reported, you can then investigate and optimize the resource allocation for the fabric. Using the zone setup and Top Talkers, you can also determine which flows are destined to any affected F\_Ports.

The bottleneck detection feature enables you to do the following:

- Prevent degradation of throughput in the fabric.  
The bottleneck detection feature alerts you to the existence and locations of devices that are causing latency. If you receive alerts for one or more F\_Ports, use the CLI to check whether these F\_Ports have a history of bottlenecks.
- Reduce the time it takes to troubleshoot network problems.  
If you notice one or more applications slowing down, you can determine whether any latency devices are attached to the fabric and where. You can use the CLI to display a history of bottleneck conditions on a port. If the CLI shows above-threshold bottleneck severity, you can narrow the problem down to device latency rather than problems in the fabric.

In Fabric OS 6.3.x, bottleneck detection was configured on a per-port basis. Starting in Fabric OS 6.4.0, you configure bottleneck detection on a per-switch basis, with per-port exclusions.



---

**NOTE**

Bottleneck detection is disabled by default. Best practice is to enable bottleneck detection on all switches in the fabric, and leave it on to continuously gather statistics.

---

## Supported configurations for bottleneck detection

Note the following configuration rules for bottleneck detection:

- Bottleneck detection is supported only on Fibre Channel ports and FCoE F\_Ports.
- Bottleneck detection is supported only on the following port types:
  - E\_Ports
  - EX\_Ports
  - F\_Ports
  - FL\_Ports
- F\_Port and E\_Port trunks are supported.
- Long distance E\_Ports are supported.
- FCoE F\_Ports are supported.
- Bottleneck detection is supported on both 4 Gbps and 8 Gbps platforms.
- Bottleneck detection is supported in Access Gateway mode.
- Bottleneck detection is supported whether Virtual Fabrics is enabled or disabled. In VF mode, bottleneck detection is supported on all fabrics, including the base fabric. See [“Virtual Fabrics considerations for bottleneck detection”](#) on page 418 for additional information on using bottleneck detection in VF mode.

## How bottlenecks are reported

Bottlenecks are reported through RASlog alerts and SNMP traps. You can set alert thresholds for the severity and duration of the bottleneck.

You can also use a CLI command to display a history of bottleneck conditions on a port. A history is maintained for a maximum of three hours for each port.

## Limitations of bottleneck detection

Using this feature for latency bottleneck detection is not recommended for link utilizations above 85%.

The bottleneck detection feature detects latency bottlenecks only at the point of egress, not ingress. For example, for E\_Ports, only the traffic egressing the port is monitored. For FCoE ports, bottleneck detection monitors traffic going from the FC side to the CEE side, and does not monitor traffic going in the reverse direction.

## High availability considerations for bottleneck detection

The bottleneck detection configuration is maintained across a failover or reboot; however, bottleneck statistics collected are lost.

## Upgrade and downgrade considerations for bottleneck detection

The bottleneck detection configuration is persistent across firmware upgrades and downgrades.

If you downgrade to Fabric OS 6.3.x, bottleneck detection is supported; however, the bottleneck configuration is not applied. You must re-apply the bottleneck configuration after the downgrade. Additionally, you must use the 6.3.x version of the bottleneck detection commands. In v6.3.x, the bottleneck commands control the feature on a per-port basis, whereas in 6.4.0 they control the feature on a per-switch (or per-logical switch) basis, with per-port exclusions and overrides. Bottleneck detection in v6.3.x does not support E\_Ports, FCoE ports, and trunks.

If you downgrade to a firmware version earlier than Fabric OS v6.3.0, bottleneck detection is no longer supported. If you later upgrade to Fabric OS 6.4.0, the switch attempts to enable the bottleneck detection settings that were enabled before the downgrade.

## Trunking considerations for bottleneck detection

A trunk behaves like a single port. Both latency and congestion bottlenecks are reported on the master port only, but apply to the entire trunk.

For masterless trunking, if the master port goes offline, the new master acquires all the configurations and bottleneck history of the old master and continues with bottleneck detection on the trunk.

## Virtual Fabrics considerations for bottleneck detection

Bottleneck detection is supported in both VF and non-VF modes.

In VF mode, if a port on which bottleneck detection is enabled is moved out of a logical switch, any per-port configurations are retained by the logical switch. The per-port configuration does not propagate outside of the logical switch. If the port is returned to the logical switch, the previous per-port configurations are automatically set for the port. See [“Changing bottleneck alert parameters”](#) on page 420 for more information about changing per-port configurations.

In logical fabrics, bottleneck detection is not performed on logical ISLs.

Because a base fabric carries traffic from multiple logical fabrics, bottlenecks reported in the base fabric can be caused by a mixture of traffic from multiple logical fabrics or by traffic from a single logical fabric. It is not possible to attribute a base fabric bottleneck to the exact logical fabric causing it. Dedicated ISLs are exclusive to one logical fabric, and any bottleneck on a dedicated ISL E\_Port pertains entirely to the traffic of that logical fabric.

## Access Gateway considerations for bottleneck detection

If bottleneck detection is enabled on a logical switch with some F\_Ports connected to an Access Gateway, you do not get information about which device is causing a bottleneck, because devices are not directly connected to this port. To detect bottlenecks on an Access Gateway, enable bottleneck detection on the Access Gateway to which the devices are actually connected.

## Enabling bottleneck detection on a switch

Bottleneck detection is enabled on a switch basis. It is recommended that you enable bottleneck detection on every switch in the fabric. If you add additional switches, including logical switches, to the fabric, be sure to enable bottleneck detection on those switches as well.

When you enable bottleneck detection on a switch, the feature is applied to all eligible ports on that switch. If ineligible ports later become eligible or, in the case of a logical switch, if ports are moved to the logical switch, bottleneck detection is automatically applied to those ports.

Enabling bottleneck detection enables both latency and congestion detection.

When you enable bottleneck detection, you also determine whether alerts are to be sent when the bottleneck conditions at a port exceed a specified threshold. These settings apply to all ports in the switch.

1. Connect to the switch and log in as admin.
2. Enter the **bottleneckmon --enable** command to enable bottleneck detection on all eligible ports on the switch.

By default, alerts are not sent unless you specify the **alert** parameter; however, you can view a history of bottleneck conditions for the port as described in [“Displaying bottleneck statistics”](#) on page 422.

3. Repeat [step 1](#) through [step 2](#) on every switch in the fabric.

---

### NOTE

Best practice is to use the default values for the **cthresh** (0.8), **lthresh** (0.1), **time** (300), and **qtime** (300) parameters. If you change the **time** parameter, you should use a setting that is 300 or higher.

---

### Example of enabling bottleneck detection

(Preferred use case) The following example enables bottleneck detection on the switch with alerts using default values for threshold and time.

```
switch:admin> bottleneckmon --enable -alert
```

The following example enables bottleneck detection on the switch without alerts. Although alerts are not delivered in bottleneck conditions, you can view the bottleneck history using the CLI.

```
switch:admin> bottleneckmon --enable
```

## Excluding a port from bottleneck detection

When you exclude a port from bottleneck detection, no data is collected from the port and no alerts are generated for the port. All statistics history for the port is discarded.

Alerting parameters for the port are preserved, so if you later include the port for bottleneck detection, the alerting parameters are restored.

Per-port exclusions might be needed if, for example, a long-distance port is known to be a bottleneck because of credit insufficiency. In general, however, per-port exclusions are not recommended.

For trunking, if you exclude a slave port from bottleneck detection, the exclusion has no effect as long as the port is a trunk slave. The exclusion takes effect only if the port becomes a trunk master or leaves the trunk.

## 18 Displaying bottleneck detection configuration details

1. Connect to the switch to which the target port belongs and log in as admin.
2. Enter the **bottleneckmon --exclude** command to exclude the port from bottleneck detection.

To later include the port, enter the **bottleneckmon --include** command.

### Example

```
switch:admin> bottleneckmon --exclude 4
```

## Displaying bottleneck detection configuration details

Using the following procedure, you can display details of the bottleneck detection configuration, including the following:

- Whether the feature is enabled
- Switch-wide alerting parameters
- Port-specific alerting parameters
- Excluded ports

1. Connect to the switch and log in as admin.
2. Enter the **bottleneckmon --status** command to display the details of bottleneck detection configuration for the switch.

### Example

```
switch:admin> bottleneckmon --status
Bottleneck detection - Enabled
=====

Switch-wide alerting parameters:
=====
Alerts - Yes
Latency threshold for alert - 0.100
Congestion threshold for alert - 0.800
Averaging time for alert - 300 seconds
Quiet time for alert - 300 seconds

Excluded ports:
=====
Port
====
12
13
14
```

## Changing bottleneck alert parameters

When you enable bottleneck detection, you can configure alert parameters that apply to every port on the switch. After you enable bottleneck detection, you can change the alert parameters on all eligible ports on the switch or on individual ports. You can also change the alert parameters on ports that have been excluded from bottleneck detection.

The alert parameters include whether alerts are sent and the threshold, time, and quiet time options.

For a trunk, you can change the alert parameters only on the master port only.

1. Connect to the switch and log in as admin.
2. Enter the **bottleneckmon --config** command to set the alert option and specify new threshold values.

Enter the **bottleneckmon --configclear** command to remove any port-specific alert parameters and revert to the switch-wide parameters.

### Example

The following example disables alerts on port 1, excludes ports 2, 3, and 4 from bottleneck monitoring, and changes the alert settings on ports 2 and 3. The **bottleneck --status** command shows the settings for these ports. Note that this example changes the alert settings on ports 2 and 3, even though they are excluded from bottleneck detection.

```
switch:admin> bottleneckmon --config -noalert 1
switch:admin> bottleneckmon --exclude 2-4
switch:admin> bottleneckmon --config -alert -lthresh .99 -cthresh .9 -time
4000 -qtime 600 2-3
switch:admin> bottleneckmon --status
Bottleneck detection - Enabled
=====

Switch-wide alerting parameters:
=====
Alerts - Yes
Latency threshold for alert - 0.100
Congestion threshold for alert - 0.800
Averaging time for alert - 300 seconds
Quiet time for alert - 300 seconds

Per-port overrides for alert parameters:
=====
Slot Port Alerts? LatencyThresh CongestionThresh Time(s) QTime(s)
=====
0 1 N -- -- -- --
0 2 Y 0.990 0.900 4000 600
0 3 Y 0.990 0.900 4000 600

Excluded ports:
=====
Port
====
2
3
4
```

### Example

The following example changes alert settings for the entire logical switch.

```
switch:admin> bottleneckmon --config -alert -lthresh .97 -cthresh .8 -time
5000
switch:admin> bottleneckmon --status
Bottleneck detection - Enabled
=====
```

## 18 Displaying bottleneck statistics

```
Switch-wide alerting parameters:
=====
Alerts                - Yes
Latency threshold for alert - 0.970
Congestion threshold for alert - 0.800
Averaging time for alert - 5000 seconds
Quiet time for alert - 300 seconds

Per-port overrides for alert parameters:
=====
Slot  Port  Alerts? LatencyThresh  CongestionThresh  Time(s)  QTime(s)
=====
0     1     N        --             --                --        --
0     2     Y        0.990          0.900            4000     600
0     3     Y        0.990          0.900            4000     600

Excluded ports:
=====
Port
=====
2
3
4
```

## Displaying bottleneck statistics

You can use the **bottleneckmon --show** command to display a history of bottleneck conditions, for up to three hours. This command has several display options:

- Display only latency bottlenecks, only congestion bottlenecks, or both combined.
- Display bottleneck statistics for a single port, bottleneck statistics for all ports on the switch, or a list of ports affected by bottleneck conditions.
- Continuously update the displayed data with fresh data.

1. Connect to the switch and log in as admin.
2. Enter the **bottleneckmon --show** command.

### Example of displaying the bottleneck history in 5-second windows over a period of 30 seconds

In this example, the definition of *bottlenecked ports* is any port that had a bottleneck occur during any second in the corresponding interval.

```
switch:admin> bottleneckmon --show -interval 5 -span 30

=====
                        Wed Jan 13 18:54:35 UTC 2010
=====
List of bottlenecked ports in most recent interval:
23
=====

From                To                Number of
bottlenecked ports
=====
Jan 13 18:54:05     Jan 13 18:54:10     1
Jan 13 18:54:10     Jan 13 18:54:15     2
Jan 13 18:54:15     Jan 13 18:54:20     1
```

Jan 13 18:54:20	Jan 13 18:54:25	1
Jan 13 18:54:25	Jan 13 18:54:30	0
Jan 13 18:54:30	Jan 13 18:54:35	0

## Disabling bottleneck detection on a switch

When you disable bottleneck detection on a switch, all bottleneck configuration details are discarded, including the list of excluded ports and non-default values of alerting parameters.

1. Connect to the switch and log in as admin.
2. Enter the **bottleneckmon --disable** command to disable bottleneck detection on the switch.

```
switch:admin> bottleneckmon --disable
```

## 18 Disabling bottleneck detection on a switch



# Managing Trunking Connections

---

## In this chapter

- [Trunking overview](#) ..... 425
- [Supported hardware](#) ..... 427
- [Recommendations for trunking groups](#) ..... 427
- [Basic trunk group configuration](#) ..... 428
- [Trunking over long distance fabrics](#) ..... 430
- [F\\_Port trunking](#) ..... 431
- [F\\_Port masterless trunking](#) ..... 433

## Trunking overview

The trunking feature optimizes the use of bandwidth by allowing a group of inter-switch links (ISLs) to merge into a single logical link. Trunking is automatically implemented for any eligible ISLs after you install the Brocade ISL Trunking license. The license must be installed on each switch that participates in trunking. For details on obtaining and installing licensed features, see [Chapter 16, “Administering Licensing”](#).

Brocade’s trunking feature supports the following trunking configurations:

- **ISL trunking** configurations are only applicable to E\_Ports.
- **F\_Port trunking** configurations are only applicable to two separate Fabric OS switches where all the ports on each switch reside in the same quad and are running at the same speed.
- **EX\_Port frame trunking** configurations are between an FC router and the edge fabric. See [“EX\\_Port frame trunking configuration”](#) on page 474 for additional information about EX\_Port trunking.
- **F\_Port Masterless trunking** configurations are on edge switches running in Access Gateway mode where the trunk ports are F\_Ports, which are connected as N\_Ports.

In a fabric with numerous switches, you can increase the bandwidth between switches by enabling multiple physical ports to appear as a single port. Enabling multiple physical ports form a trunking group where the traffic is distributed dynamically and in order at the frame level, thus achieving greater performance with fewer inter-switch links. Trunking groups are based on the user port number with contiguous eight ports as one group, such as 0-7, 8-15, and 16-23.

Trunking is performed based on the Quality of Service (QoS) configuration on the master and the slave ports. That is, in a given trunk group, if there are some ports with QoS enabled and some with QoS disabled, they form two different trunks, one with QoS enabled and the other with QoS disabled. For more information on QoS, refer to [“QoS zones”](#) on page 406.

Re-initializing ports for trunking is required after you install the license so that the ports know that trunking is enabled. You can enable or disable trunking for a single port or for an entire switch. For trunking to work, individual ports or the entire switch must be set at the same speed and at the same mode, for example, 2 Gbps, 4 Gbps, 8 Gbps, or autonegotiate. For more information on setting port speeds, see “Trunking over long distance fabrics” on page 430.

Figure 64 illustrates how trunking can result in more throughput by distributing data over four ISLs with no congestion. In a fabric that does not have trunking capability, some paths would be congested and other paths underutilized.

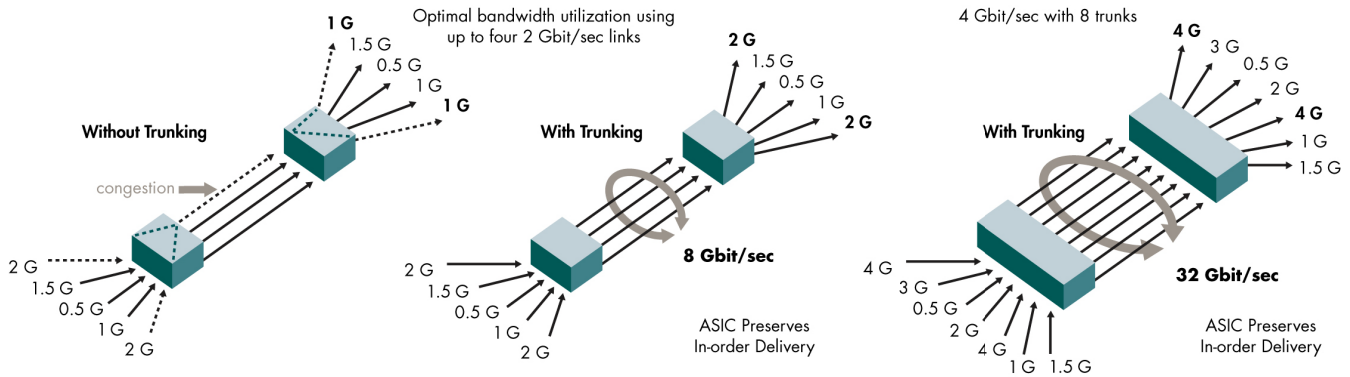

FIGURE 64 Distribution of traffic over ISL Trunking groups

## Criteria for managing trunking connections

Following is the criteria for managing trunking connections:

- You can have up to eight ports in one trunk group to create high performance 32 Gbps ISL trunks between switches and up to 64 Gbps if there are eight ISLs with 8 Gbps each if 8 Gbps is supported.
- Trunk links can be 2 Gbps, 4 Gbps, or 8 Gbps depending on the Brocade platform.
- The maximum number of ports per trunk and trunks per switch depends on the Brocade platform.
- There must be a direct connection between participating switches.
- In Fabric OS v6.1.0 and later, you can configure EX\_Ports to use frame-based trunking just like regular E\_Ports. The EX\_Port restrictions are the same as E\_Ports. An E\_Port or EX\_Port trunk can be up to eight ports wide. All the ports must be adjacent to each other using the clearly marked groups on the front of the product See “EX\_Port frame trunking configuration” on page 474 for additional information about EX\_Port trunking.
- The switch must be set to **interopMode 0** for Brocade Native mode, which supports all stand-alone Brocade switches, but provides no interoperability support. See “Interoperability for Merged SANs” on page 297 for information and procedures related to interoperability.
- The port ISL R\_RDY mode must be disabled (using the **portCfgIsMode** command).

Trunks operate best when the cable length of each trunked link is roughly equal to the others in the trunk. For optimal performance, no more than 30 meters difference is recommended. Trunks are compatible with both short wavelength (SWL) and long wavelength (LWL) fiber optic cables and transceivers.

## Supported hardware

Trunking is supported on the FC ports of all Brocade platforms and blades supported in Fabric OS v6.4.0.

## Recommendations for trunking groups

To identify the most useful trunking groups, consider the following recommendations along with the standard guidelines for SAN design:

- Evaluate the traffic patterns within the fabric.
- Place trunking-capable switches adjacent to each other.  
This maximizes the number of trunking groups that can form. If you are using a core and edge topology, place trunking-capable switches at the core of the fabric and any switches that are not trunking-capable at the edge of the fabric.
- When connecting two switches with two or more ISLs, ensure that all trunking requirements are met to allow a trunking group to form.
- Determine the optimal number of trunking groups between each set of linked switches, depending on traffic patterns and port availability.  
The goal is to avoid traffic congestion without unnecessarily using ports that could be used to attach other switches or devices. Consider these points:
  - Each physical ISL uses two ports that could otherwise be used to attach node devices or other switches.
  - Trunking groups can be used to resolve ISL oversubscription if the total capability of the trunking group is not exceeded.
- Consider how the addition of a new path will affect existing traffic patterns:
  - A trunking group has the same link cost as the master ISL of the group, regardless of the number of ISLs in the group. This allows slave ISLs to be added or removed without causing data to be rerouted, because the link cost remains constant.
  - The addition of a path that is shorter than existing paths causes traffic to be rerouted through that path.
  - The addition of a path that is longer than existing paths may not be useful because the traffic will choose the shorter paths first.
- Plan for future bandwidth addition to accommodate increased traffic.  
For trunking groups over which traffic is likely to increase as business requirements grow, consider leaving one or two ports in the group available for future nondisruptive addition of bandwidth.
- Consider creating redundant trunking groups where additional ports are available or paths are particularly critical.  
This helps to protect against oversubscription of trunking groups, multiple ISL failures in the same group, and the rare occurrence of an ASIC failure.
- To provide the highest level of reliability, deploy trunking groups in redundant fabrics to further ensure that ISL failures do not disrupt business operations.

## Basic trunk group configuration

[Re-initializing ports for trunking](#) is required after you install the ISL Trunking license. You must re-initialize the ports being used for ISLs so that they recognize that trunking is enabled. This procedure needs to be performed only one time. To re-initialize the ports, you can either disable and then re-enable the switch, or disable and then re-enable the affected ports.

You can enable or disable Trunking for a single port or for an entire switch. When you issue the **portCfgTrunkPort** or **switchCfgTrunk** command to update the trunking configuration, the ports to which the configuration applies are disabled and re-enabled with the new trunk configuration. As a result, traffic through those ports can be disrupted.

[Displaying trunking information](#) is useful to view the following information:

- All the trunks and members of a trunk.
- Whether the trunking port connection is the master port connection for the trunking group.
- That trunks are formed correctly.
- Trunking information for a switch that is part of an FC Router backbone fabric interlinking several edge fabrics.
- Trunking information, including bandwidth and throughput for all the trunk groups in a switch.

Use the **portPerfShow** command to monitor problem areas where there are congested paths or dropped links to determine if you need to adjust the fabric design by adding, removing, or reconfiguring ISLs and trunking groups. For additional information on the Brocade Advanced Performance Monitor to monitor traffic, see [“Monitoring Fabric Performance”](#) on page 383.

### Re-initializing ports for trunking

1. Connect to the switch and log in using an account assigned to the admin role.
2. Enter the **isShow** command to determine which ports are used for ISLs.
3. Enter the **portDisable** command for each ISL port.
4. Enter the **portEnable** command for each port that you disabled in [step 3](#).

### Enabling Trunking on a port

1. Connect to the switch and log in using an account assigned to the admin role.
2. Enter the **portCfgTrunkPort** command to enable trunking. In the following example, trunking is being enabled on slot 1, port 3.

```
switch:admin> portcfgtrunkport 1/3 1
```

### Enabling Trunking on a switch

1. Connect to the switch and log in using an account assigned to the admin role.
2. Enter the **switchCfgTrunk** command.

Mode 1 enables and mode 0 disables ISL Trunking for all ports on the switch.

```
switch:admin> switchcfgtrunk 1
Committing configuration...done.
```

## Displaying trunking information

1. Connect to the switch and log in using an account assigned to the admin role.
2. Enter the **trunkShow** command.

This example shows trunking groups 1, 2, and 3; ports 4, 13, and 14 are masters.

```
switch:admin> trunkshow
1: 6-> 4 10:00:00:60:69:51:43:04 99 deskew 15 MASTER

2: 15-> 13 10:00:00:60:69:51:43:04 99 deskew 16 MASTER
   12-> 12 10:00:00:60:69:51:43:04 99 deskew 15
   14-> 14 10:00:00:60:69:51:43:04 99 deskew 17
   13-> 15 10:00:00:60:69:51:43:04 99 deskew 16

3: 24-> 14 10:00:00:60:69:51:42:dd 2 deskew 15 MASTER
```

This example shows trunking information for a switch that is part of an FC Router backbone fabric interlinking several edge fabrics. EX\_Port with WWN 10:00:00:05:1e:35:b3:03 and the E\_Port with WWN 10:00:00:05:1e:37:12:13 are masters.

```
switch:admin> trunkshow
4: 49-> 0 10:00:00:05:1e:35:b3:03 4 deskew 16 MASTER
   54-> 2 10:00:00:05:1e:35:b3:03 4 deskew 16
   53-> 5 10:00:00:05:1e:35:b3:03 4 deskew 16
   50-> 6 10:00:00:05:1e:35:b3:03 4 deskew 15
   51-> 4 10:00:00:05:1e:35:b3:03 4 deskew 16
   52-> 7 10:00:00:05:1e:35:b3:03 4 deskew 67
   55-> 3 10:00:00:05:1e:35:b3:03 4 deskew 16
   48-> 1 10:00:00:05:1e:35:b3:03 4 deskew 15

5: 71-> 22 10:00:00:05:1e:37:12:13 4 deskew 17 MASTER
   67-> 17 10:00:00:05:1e:37:12:13 4 deskew 16
   70-> 20 10:00:00:05:1e:37:12:13 4 deskew 16
   69-> 21 10:00:00:05:1e:37:12:13 4 deskew 16
   66-> 18 10:00:00:05:1e:37:12:13 4 deskew 17
   68-> 23 10:00:00:05:1e:37:12:13 4 deskew 17
   64-> 16 10:00:00:05:1e:37:12:13 4 deskew 15
   65-> 19 10:00:00:05:1e:37:12:13 4 deskew 16
```

This example shows trunking information along with the bandwidth and throughput for all the trunk groups in a switch.

```
switch:admin> trunkshow -perf
1: 2-> 2 10:00:00:05:1e:81:56:8b 1 deskew 15 MASTER
   3-> 3 10:00:00:05:1e:81:56:8b 1 deskew 17
   Tx: Bandwidth 4.00Gbps, Throughput 1.66Gbps (48.45%)
   Rx: Bandwidth 4.00Gbps, Throughput 1.66Gbps (48.44%)
   Tx+Rx: Bandwidth 8.00Gbps, Throughput 3.33Gbps (48.44%)

2: 5->113 10:00:00:05:1e:46:42:01 3 deskew 15 MASTER
   4->112 10:00:00:05:1e:46:42:01 3 deskew 15
   Tx: Bandwidth 16.00Gbps, Throughput 1.67Gbps (12.12%)
   Rx: Bandwidth 16.00Gbps, Throughput 1.67Gbps (12.12%)
   Tx+Rx: Bandwidth 32.00Gbps, Throughput 3.33Gbps (12.12%)

3: 10-> 10 10:00:00:05:1e:81:56:8b 1 deskew 15 MASTER
   11-> 11 10:00:00:05:1e:81:56:8b 1 deskew 15
   Tx: Bandwidth 4.00Gbps, Throughput 1.66Gbps (48.45%)
   Rx: Bandwidth 4.00Gbps, Throughput 1.67Gbps (48.48%)
   Tx+Rx: Bandwidth 8.00Gbps, Throughput 3.33Gbps (48.46%)
```

```

4: 12->892 10:00:00:05:1e:46:42:01    3 deskew 15 MASTER
13->893 10:00:00:05:1e:46:42:01    3 deskew 15
Tx: Bandwidth 16.00Gbps, Throughput 1.67Gbps (12.12%)
Rx: Bandwidth 16.00Gbps, Throughput 1.66Gbps (12.11%)
Tx+Rx: Bandwidth 32.00Gbps, Throughput 3.33Gbps (12.11%)

```

## Trunking over long distance fabrics

In long-distance fabrics, if a port speed is set to autonegotiate, then the maximum speed, which is 8 Gbps, is assumed for reserving buffers for the port. If the port is only running at 2 Gbps, this wastes buffers. On the Brocade 300, 4100, 4900, 5100, 5300, 5410, 5424, 5450, 5480, 7800, 8000, VA-40FC, and 48000 platforms, for long-distance ports, you should specify the port speed instead of setting it to autonegotiate.

Support for 8 Gbps is only between the following:

- Between the Brocade 48000 and Brocade DCX (including DCX-4S) platforms with the appropriate 8-Gbps blades
- Between Brocade DCX (including DCX-4S) platforms with the appropriate 8-Gbps blades
- Between Brocade 300, 5100, 5300, 5410, 5424, 5450, 5480, and VA-40FC switches with the 8 Gbps SFPs installed.

The Brocade 300, 5100, 5300, 5410, 5424, 5450, 5480, and VA-40FC support long-distance modes LO, LE, LS, and LD. The distance supported on each platform depends on the available buffers, number of back-end ports, and number of offline ports.

In addition to the criteria listed in [“Criteria for managing trunking connections”](#) on page 426, observe the following criteria for trunking over extended fabrics:

- It is supported only on switches running Fabric OS v6.1.0 and later.
- Extended Fabrics and ISL Trunking licenses are required on all participating switches.
- When configuring long distance, the `portCfgLongDistance --vc_translation_link_init` parameter must be set the same on all ports in an extended fabric.

For additional information on configuring long distance, see [“Configuring an extended ISL”](#) on page 443. [Table 86](#) describes Trunking over long distance support for the Brocade 4100 and 4900 platforms.

**TABLE 86** Trunking support for Brocade 4100 and 4900

Long distance mode	Distance	Number of 2 Gbps ports	Number of 4 Gbps ports
LE	10 km	32 (four 8-port trunks)	32 (four 8-port trunks)
LD	200 km	3 (one 3-port trunk)	0
LD	250 km	3 (one 3-port trunk)	0
LD	500 km	0	0

[Table 87](#) on page 431 describes Trunking over long distance support for the Brocade 48000, the DCX Backbone, and the DCX-4S platforms and supported blades.

**TABLE 87 Trunking over distance for the Brocade 48000, DCX Backbone, and the DCX-4S**

Long distance mode	Distance	Number of 2 Gbps ports	Number of 4 Gbps ports
LE	10 km	48 (six 8-port trunks)	48 (six 8-port trunks)
L0	Normal	See note below	48 (six 8-port trunks)
LD	200 km	4 (one 2-port trunk per switch)	0
LD	250 km	4 (one 2-port trunk per switch)	0
LD	500 km	0	0
LS	Static	See note below	

**NOTE**

The L0 mode supports up to 5 km at 2 Gbps, up to 2 km at 4 Gbps, and up to 1 km at 8 Gbps. The distance for the LS mode is static. You can specify any distance greater than 10 km.

The distance supported on the DCX-4S depends on the available buffers, number of back-end ports, and the number of ports that are offline. For more information on setting port speeds, refer to [“Performing Advanced Configuration Tasks”](#) on page 35.

## F\_Port trunking

F\_Port trunking is enabled between two separate Fabric OS switches that support trunking and where all the ports on each switch reside in the same quad and are running the same speed. Trunk groups form when you connect two or more cables on one Fabric OS switch to another Fabric OS switch with ports in the same port group or quad. A port group or a quad is a set of sequential ports, for example ports 0-3 in the figure shown below. The Brocade 300, 5100, 5300, 5410, 5424, 5450, 5480, 8000, and VA-40FC platforms support a trunk group with up to eight ports. The trunking groups are based on the user port number, with contiguous eight ports as one group, such as 0-7, 8-15, 16-23 and up to the number of ports on the switch.

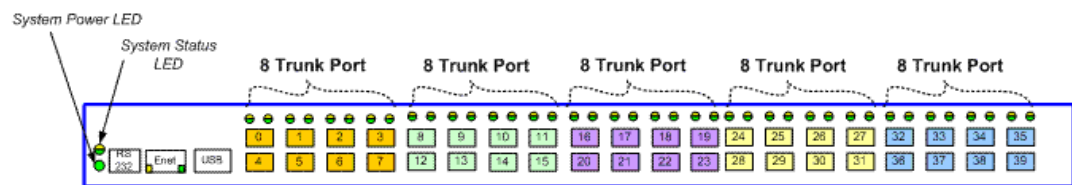

**FIGURE 65 Trunk group configuration for the Brocade 5100**

## Prerequisites for F\_Port trunking

Make sure that the following conditions exist before attempting F\_Port trunking:

- Both modules (edge switch and the switch running in AG mode) have the Trunking licenses enabled.
- The ports have Trunking enabled by displaying the port configuration using the `portCfgShow` command.
- The ports are set to the same speed within the trunk.

- The edge switch F\_Port trunk ports are connected within the ASIC-supported trunk group on the AG switch.
- Both switches are running the same Fabric OS versions.
- Trunking is enabled on all ports to be included in a Trunk Area (TA) before you attempt to create a Trunk Area
- Keep in mind that F\_Port trunking does not support shared area ports on the FC8-48 and FC4-48 blades in the Brocade 48000. F\_Port trunking *is* supported on the shared area ports on the FC8-48 and FC8-64 in the Brocade DCX and DCX-4S.

## Enabling F\_Port trunking

1. Connect to the switch and log in using an account assigned to the admin role.
2. Enter the **portDisable** command to disable the ports that are to be assigned to the trunk area.
3. Enter the **portTrunkArea --enable** command to create the trunk area.

```
switch:admin> portdisable 0-2
switch:admin> porttrunkarea --enable 0-2 -index 2
Trunk index 2 enabled for ports 0, 1, and 2.
```

## Disabling F\_Port trunking

1. Connect to the switch and log in using an account assigned to the admin role.
2. Enter the **portDisable** command to disable the ports that are to be removed from the trunk area.
3. Enter the **portTrunkArea --disable** command to remove ports from the trunk area.

This command does not unassign a TA if its previously assigned Area\_ID is the same address identifier (Area\_ID) of the TA unless all the ports in the trunk group are specified to be unassigned.

```
switch:admin> portdisable 0-2
switch:admin> porttrunkarea --disable 0-2
Trunk index 2 disabled for ports 0, 1, and 2.
```

## F\_Port trunking in Virtual Fabrics

F\_Port trunking functionality performs the same in Virtual Fabrics as it does in non-virtual fabric platforms except for the Brocade DCX. Fabric OS uses a 10-bit addressing model, which is the default mode for all dynamically created logical switches in the DCX platform.

In the DCX platform, F\_Port trunk ports dynamically receive an 8-bit area address that remains persistent. After F\_Port trunking configurations are removed from a port in a logical switch, that port returns to the default 10-bit area address model, which supports up to 1024 F\_Ports in a logical switch.

---

### NOTE

Because the DCX platform has a maximum of 576 ports, out of the 1024 10-bit address range, addresses 448-1023 are reserved for the 10-bit address space. Addresses 0-447 are reserved for assigning to NPIV/Loop ports to support 112 [448/4] NPIV/Loop ports in a logical switch with 256 devices each.

---



The DCX-4S supports trunk groups with up to eight ports. The trunking groups are based on the user port number with contiguous eight ports as one group, for example 0-7, 8-15, and 16-23.

## F\_Port trunking considerations for Virtual Fabrics

Following are the F\_Port trunking considerations for virtual fabrics:

- If a port is enabled for F\_Port trunking, then you must disable the configuration before you can move a port from the logical switch.
- If the user bound area for a port is configured using the **portAddress** command, then the port cannot be configured as an F\_Port trunk port. You must explicitly remove the user bound area before enabling F\_Port trunking.
- If you swap a port using the **portSwap** command, then you must undo the port swap before enabling F\_Port trunking.
- The Port WWN format in a Virtual Fabric is 2z:zz:xx:xx:xx:xx:xx:xx. The z:zz is the logical port number, for example, the logical port 450 will be 1:c2. The xx:xx:xx:xx:xx:xx is based on the logical fabric's WWN, for example, if the logical fabric's WWN is 10:00:00:05:1e:39:fa:f3, and logical port number is 450, then the Port WWN of the F\_Port trunk will be 21:c2:00:05:1e:39:fa:f3.
- F\_Port trunks are not allowed on the base switch.

---

### NOTE

A base switch is a logical switch that is used to communicate among different logical switches.

---

- F\_Port trunks enabled on Fabric OS v6.2.0 are non-disruptive to Fabric v6.4.0.
- If F\_Port trunking is enabled on some ports in the default switch, and you disable Virtual Fabrics, all of the F\_Port trunking information is lost.
- The ports in a trunk group can be partitioned into different logical switches, therefore all of the ports in an F\_Port trunk must belong to a single trunk group of ports on the platform and must also belong to the same logical switch.

## F\_Port masterless trunking

On edge switches, the masterless trunking feature is called F\_Port masterless trunking because it trunks F\_Ports on the switches running in Access Gateway (AG) mode. If the switch is in AG mode, the trunk ports must be F\_Ports that are connected to N\_Ports. The ISL trunking feature supports N\_Port connections for edge switches running Fabric OS 6.2.0 or later.

This feature keeps F\_Ports from becoming disabled when they are mapped to an N\_Port on a switch in Access Gateway mode. With F\_Port trunking, any link within a trunk can go offline or become disabled, but the trunk remains fully functional and there are no reconfiguration requirements.

The following table describes the PWWN format for F\_Port and N\_Port trunk ports.

**TABLE 88** PWWN format for F\_Port and N\_Port trunk ports

NAA = 2 (1)	2f:xx:nn:nn:nn:nn:nn	Port WWNs for: switch's Fx_Ports.	The valid range of xx is [0 - FF], for maximum of 256.
NAA = 2 (1)	25:xx:nn:nn:nn:nn:nn	Port WWNs for: switch's FX_Ports	The valid range of xx is [0 - FF], for maximum of 256.

F\_Port trunking prevents reassignments of the Port ID (also referred to as the Address Identifier as described in Table 90 on page 438) when F\_Ports go offline and it increases F\_Port bandwidth. F\_Port masterless trunking interoperates between AG 2 Gbps, 4 Gbps, and 8 Gbps-based platforms. This feature does not work on M-EOS or third party switches. Figure 66 shows a switch in AG mode without F\_Port masterless trunking. Figure 67 shows a switch in AG mode with F\_Port masterless trunking.

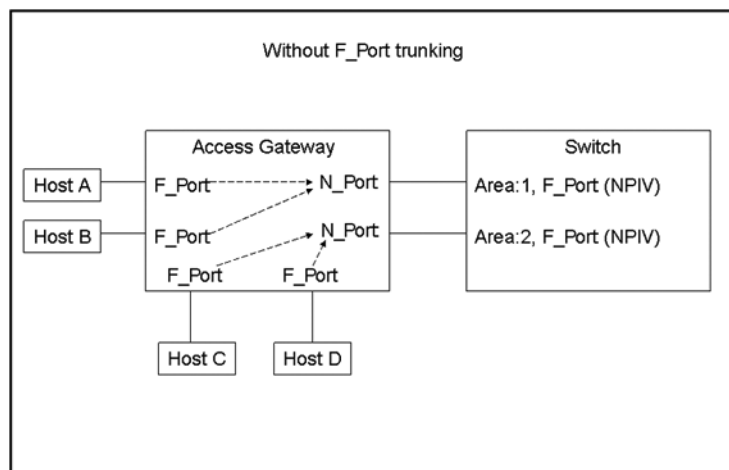

**FIGURE 66** Switch in Access Gateway mode without F\_Port trunking

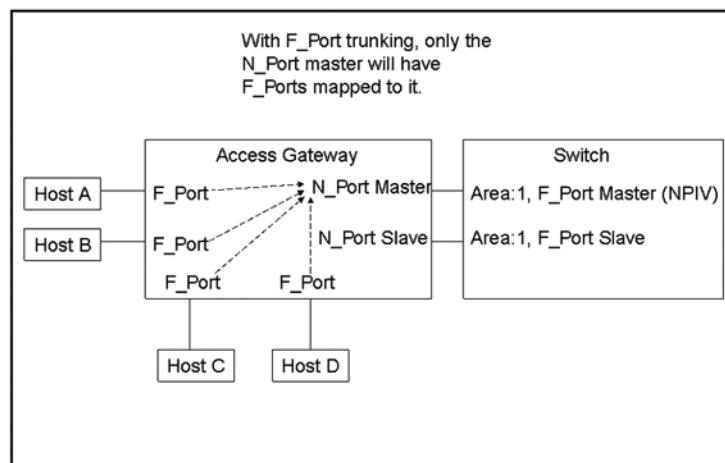

**FIGURE 67** Switch in Access Gateway mode with F\_Port masterless trunking

**NOTE**

You do not need to manually map the host to the master port because Access Gateway will perform a cold failover to the master port.

To implement F\_Port masterless trunking, you must first configure an F\_Port trunk group and statically assign an Area\_ID within the trunk group. Assigning a Trunk Area (TA) to a port or trunk group enables F\_Port masterless trunking on that port or trunk group.

## F\_Port masterless trunking considerations

Table 89 describes the F\_Port masterless trunking considerations.

**TABLE 89** F\_Port masterless trunking considerations

Category	Description
Access Gateway mode	Does not support F_Port trunking. It only supports N_Port trunking in AG mode.
AD	You cannot create a Trunk Area on ports with different Admin Domains. You cannot create a Trunk Area in AD255.
Area assignment	<p>You statically assign the area within the trunk group on the edge switch. That group is the F_Port masterless trunk.</p> <p>The static trunk area you assign must fall within the ASIC's trunk group of the switch or blade starting from port 0.</p> <p>The static trunk area you assign must be one of the port's default areas of the trunk group.</p> <p>10-bit addressing is the default mode for all dynamically created partitions in the Brocade DCX platform.</p>
Authentication	<p>Authentication occurs only on the F_Port trunk master port and only once per the entire trunk. This behavior is the same as E_Port trunk master authentication. Because only one port in the trunk does FLOGI to the switch, and authentication follows FLOGI on that port, only that port displays the authentication details when you issue the <b>portShow</b> command.</p> <p><b>Note:</b> Switches in Access Gateway mode do not perform authentication.</p>
configdownload	<p>If you issue the <b>configDownload</b> command for a port configuration that is not compatible with F_Port trunking, and the port is Trunk Area-enabled, then the port will be persistently disabled.</p> <p><b>Note:</b> Configurations that are not compatible with F_Port trunking are long distance, port mirroring, non-CORE_PID, and Fast Write.</p>

TABLE 89 F\_Port masterless trunking considerations (Continued)

Category	Description
D.I. Zoning (D,I) AD (D,I) DCC and (PWWN,I) DCC	<p>Creating a Trunk Area may remove the Index ("I") from the switch to be grouped to the Trunk Area. All ports in a Trunk Area share the same "I". This means that <i>domain,index</i> (D,I), which refer to an "I" that might have been removed, will no longer be part of the switch.</p> <p><b>Note:</b> Ensure to include AD, zoning, and DCC when creating a Trunk Area.</p> <p>You can remove the port from the Trunk Area to have the "I" back into effect. D,I behaves as normal, but you may see the effects of grouping ports into a single "I".</p> <p>Also, D,I continues to work for Trunk Area groups. The "I" can be used in D,I if the "I" was the "I" for the Trunk Area group.</p> <p><b>Note:</b> "I" refers to Index and D,I refers to Domain,Index.</p>
DCC Policy	DCC policy enforcement for the F_Port trunk is based on the Trunk Area; the FDISC requests to a trunk port are accepted only if the WWN of the attached device is part of the DCC policy against the TA. The PWWN of the FLOGI sent from the AG will be dynamic for the F_Port trunk master. Because you do not know ahead of time what PWWN AG will use, the PWWN of the FLOGI will not go through DCC policy check on an F_Port trunk master. However, the PWWN of the FDISC will continue to go through DCC policy check.
Default Area	Port X is a port that has its Default Area the same as its Trunk Area. The only time you can remove port X from the trunk group is if the entire trunk group has the Trunk Area disabled.
Downgrade	<p>You can have trunking on, but you must disable the trunk ports before performing a firmware downgrade.</p> <p><b>Note:</b> Removing a Trunk Area on ports running traffic is disruptive because you must disable the port to disable the Trunk Area on the port. Use caution before assigning a Trunk Area if you need to downgrade to a firmware version earlier than Fabric OS v6.2.0.</p>
Fastwrite	When you assign a Trunk Area to a trunk group, the trunk group cannot have Fastwrite enabled on those ports; if a port is Fastwrite-enabled, the port cannot be assigned a Trunk Area.
FC4-32 blade	For the Brocade 48000: If an FC4-32 blade has the Trunk Area enabled on ports 16 - 31 and the blade is swapped with an FC4-48 or FC8-48 blade, the Trunk Area ports will be persistently disabled. You can run the <b>portTrunkArea</b> command to assign a Trunk Area on those ports.
FC4-48 blade	On the FC4-48 blade, F_Port masterless trunking is supported only on ports 0 - 15.
FICON	FICON is not supported on F_Port trunk ports. However, FICON can still run on ports that are not F_Port trunked within the same switch.
HA Sync	If you plug in a standby CP with a firmware version earlier than Fabric OS v6.2.0 and a Trunk Area is present on the switch, the CP blades will become out of sync.
ICL Port	F_Port trunks are not allowed on Inter-Chassis Link (ICL) Ports. The <b>portTrunkArea</b> command does not allow it.
Long Distance	Long distance is not allowed on F_Port trunks, which means a Trunk Area is not allowed on long-distance ports; you cannot enable long distance on ports that have a Trunk Area assigned to them.

**TABLE 89 F\_Port masterless trunking considerations (Continued)**

Category	Description
Management Server	Registered Node ID (RNID), Link Incident Record Registration (LIRR), and Query Security Attribute (QSA) ELSs are not supported on F_Port trunks.
NPIV	Supported on F_Port master trunk.
PID format	F_Port masterless trunking is only supported in the CORE PID format.
Port mirroring	Port mirroring is not supported on Trunk Area ports or on the PID of an F_Port trunk port.
Port Swap	When you assign a Trunk Area to a trunk group, the Trunk Area cannot be port swapped; if a port is swapped, then you cannot assign a Trunk Area to that port.
Port Types	Only F_Port trunk ports are allowed on a Trunk Area port. All other port types are persistently disabled.
portCfgTrunkPort <i>port</i> , 0	The <b>portCfgTrunkPort</b> <i>port</i> , 0 command will fail if a Trunk Area is enabled on a port. The port Trunk Area must be disabled first.
PWWN	The entire Trunk Area trunk group shares the same Port WWN within the trunk group. The PWWN is the same across the F_Port trunk that has 0x2f or 0x25 as the first byte of the PWWN. The TA is part of the PWWN in the format listed in <a href="#">Table 88</a> on page 434.
QoS	Not currently supported.
Routing	Routing will route against the F_Port trunk master. Port and exchange-based routing is supported on the F_Port trunk masters. Bandwidth information will be modified accordingly as the F_Port trunk forms.
switchCfgTrunk 0	The <b>switchCfgTrunk</b> 0 command will fail if a port has TA enabled. All ports on a switch must be TA-disabled first.
Trunk area	The port must be disabled before assigning a Trunk Area on the edge switch to the port or removing a Trunk Area from a trunk group.  You cannot assign a Trunk Area to ports if the standby CP is running a firmware version earlier than Fabric OS v6.2.0.
Trunk Master	No more than one trunk master in a trunk group. The second trunk master will be persistently disabled with reason "Area has been acquired".
Trunking	You must first enable Trunking on the port before the port can have a Trunk Area assigned to it.
Two masters	Two masters are not supported in the same F_Port trunk group.
Upgrade	There are no limitations on upgrading to Fabric OS v6.4.0 if the F_Port is present on the switch. Upgrading is not disruptive.

## Assigning a Trunk Area

Ports from different ADs are not allowed to join the same Trunk Area group. The **portTrunkArea** command prevents the different ADs from joining the TA group.

When you assign a TA, the ports within the TA group have the same Index. The Index that was assigned to the ports is no longer part of the switch. Any Domain,Index (D,I) AD that was assumed to be part of the domain may no longer exist for that domain because it was removed from the switch.

**Example : How Trunk Area assignment affect the port Domain,Index**

If you have AD1: 3,7; 3,8; 4,13; 4,14 and AD2: 3,9; 3,10, and then create a TA with Index 8 with ports that have index 7, 8, 9, and 10, then index 7, 9, and 10 are no longer with domain 3. This means that AD2 does not have access to any ports because index 9 and 10 no longer exist on domain 3. This also means that AD1 no longer has 3,7 in effect because Index 7 no longer exists for domain 3. AD1's 3,8, which is the TA group, can still be seen by AD1 along with 4,13 and 4,14.

A port within a TA can be removed, but this adds the Index back to the switch. For example, the same AD1 and AD2 with TA 8 holds true. If you remove port 7 from the TA, it adds Index 7 back to the switch. That means AD1's 3,7 can be seen by AD1 along with 3,8; 4,13 and 4,14.

When you assign an area within a trunk group, that group is F\_Port masterless trunking enabled. The TA that you assign must be within the 8-port trunk group beginning with port 0 (zero). After you assign a TA to a port, the port immediately acquires the TA as the area of its PID. Likewise, after you remove a TA from a port, the port immediately acquires the default area as its PID. F\_Port trunking prevents reassignments of the Port ID also referred to as the Address Identifier. [Table 90](#) shows an example of an Address Identifier.

**TABLE 90 Address identifier**

23	22	21	20	19	18	17	16	15	14	13	12	11	10	9	8	7	6	5	4	3	2	1	0
Domain ID								Area_ID								Port ID							
Address Identifier																							

1. Connect to the switch and log in using an account assigned to the admin role.
2. Enter the **portDisable** command for each port to be included in the TA.
3. Enter the **portTrunkArea --enable** command to enable the Trunk Area for ports 36-39 with index number 37.

```
switch:admin> porttrunkarea --enable 36-39 -index 37
Trunk index 37 enabled for ports 36, 37, 38 and 39.
```

When you assign a trunk area on a port, it enables trunking on the F\_Ports automatically. This command does not unassign a TA if its previously assigned Area\_ID is the same address identifier (Area\_ID) of the TA unless all the ports in the trunk group are specified to be unassigned.

4. Re-enable ports 36-39 by issuing **portEnable** for each port in the TA.
5. Enter the **switchshow** command to display the switch and port information.
6. Enter the **porttrunkarea --show enabled** command to display the TA-enabled port configuration.

```
switch:admin> porttrunkarea --show enabled
```

Port	Type	State	Master	TA	DA
36	F-port	Master	36	37	36
37	F-port	Slave	36	37	37
38	F-port	Slave	36	37	38
39	F-port	Slave	36	37	39

7. Enter the **porttrunkarea --show trunk** command to display the trunking information.

```
switch:admin> porttrunkarea --show trunk
Trunk Index 37: 39->0 sp: 8.000G bw: 16.000G des skew 15 MASTER
Tx: Bandwidth 16.00Gbps, Throughput 1.63Gbps (11.84%)
```

```

Rx: Bandwidth 16.00Gbps, Throughput 1.62Gbps (11.76%)
Tx+Rx: Bandwidth 32.00Gbps, Throughput 3.24Gbps (11.80%)
      38->1  sp: 8.000G bw: 8.000G deskew 15
Tx: Bandwidth 16.00Gbps, Throughput 1.63Gbps (11.84%)
Rx: Bandwidth 16.00Gbps, Throughput 1.62Gbps (11.76%)
Tx+Rx: Bandwidth 32.00Gbps, Throughput 3.24Gbps (11.80%)
      37->1  sp: 8.000G bw: 8.000G deskew 15
Tx: Bandwidth 16.00Gbps, Throughput 1.63Gbps (11.84%)
Rx: Bandwidth 16.00Gbps, Throughput 1.62Gbps (11.76%)
Tx+Rx: Bandwidth 32.00Gbps, Throughput 3.24Gbps (11.80%)
      36->1  sp: 8.000G bw: 8.000G deskew 15
Tx: Bandwidth 16.00Gbps, Throughput 1.63Gbps (11.84%)
Rx: Bandwidth 16.00Gbps, Throughput 1.62Gbps (11.76%)
Tx+Rx: Bandwidth 32.00Gbps, Throughput 3.24Gbps (11.80%)

```

## Enabling the DCC policy on a Trunk Area

After you assign a Trunk Area, the **portTrunkArea** CLI checks whether there are any active DCC policies on the port with the index TA, and then issues a warning to add all the device WWNs to the existing DCC policy with index as TA.

All DCC policies that refer to an Index that no longer exists will not be in effect.

1. Add the WWN of all the devices to the DCC policy against the TA.
2. Enter the **secPolicyActivate** command to activate the DCC policy.

You must enable the TA before issuing the **secPolicyActivate** command in order for security to enforce the DCC policy on the trunk ports.

3. Turn on the trunk ports.

Trunk ports should be turned on after issuing the **secPolicyActivate** command to prevent the ports from becoming disabled in the case where there is a DCC security policy violation.

You can configure authentication on all three Brocade trunking configurations. For more information on authentication, see [Chapter 7, “Configuring Security Policies”](#).

## 19 F\_Port masterless trunking



# Managing Long Distance Fabrics

---

## In this chapter

- [Long distance fabrics overview](#) ..... 441
- [Extended Fabrics device limitations](#) ..... 442
- [Long distance link modes](#) ..... 442
- [Configuring an extended ISL](#) ..... 443
- [Buffer credit management](#) ..... 445
- [Buffer credit recovery](#) ..... 453

## Long distance fabrics overview

The most effective configuration for implementing long-distance SAN fabrics is to deploy Fibre Channel switches at each location in the SAN. Each switch handles local interconnectivity and multiplexes traffic across long-distance dark fiber or wave division multiplexing (WDM) links while the Brocade Extended Fabrics software enables SAN management over long distances. Brocade Extended Fabrics is an optional licensed feature for Brocade SAN deployment over distance beyond 10 km. A Brocade Extended Fabrics license is required before you can implement long distance dynamic (LD) and long distance static (LS) distance levels. The LD and LS settings are necessary to achieve maximum performance results over Inter-Switch Links (ISLs) that are greater than 10 km. For details on obtaining and installing licensed features, see [Chapter 16, “Administering Licensing”](#). The Extended Fabrics feature enables the following:

- **Fabric interconnectivity over Fibre Channel at longer distances**

ISLs can use long distance dark fiber connections to transfer data. Wave division multiplexing, such as DWDM (Dense Wave Division Multiplexing), CWDM (Coarse Wave Division Multiplexing), and TDM (Time Division Multiplexing), can be used to increase the capacity of the links. As Fibre Channel speeds increase, the maximum distance decreases for each switch. The Extended Fabrics feature extends the distance the ISLs can reach over an extended fiber. This is accomplished by providing enough buffer credits on each side of the link to compensate for latency introduced by the extended distance.
- **Simplified management over distance**

Each device attached to the SAN appears as a local device, an approach that simplifies deployment and administration.
- **Optimized switch buffering**

When Extended Fabrics is installed on gateway switches (E\_Port connectivity from one switch to another), the ISLs (E\_Ports) are configured with a large pool of buffer credits. The enhanced switch buffers help ensure that data transfer can occur at near-full bandwidth to efficiently utilize the connection over the extended links. This ensures the highest possible performance on ISLs.

## Extended Fabrics device limitations

Extended Fabrics is normally not implemented on the following devices:

- 7600 and the FA4-18 blade - The 7600 and the FA4-18 blade have two Gigabit Ethernet ports and 16 FC ports. The two Gigabit Ethernet ports are for use by storage applications, and generally the FC ports on these devices are used to connect devices used by the storage applications.
- FC4-16IP blade - The FC4-16IP blade has eight Gigabit Ethernet ports and eight FC ports. It is used to implement the iSCSI Gateway Service. The Gigabit Ethernet ports are used to connect iSCSI initiators, and the FC ports are used to connect to any device.
- FC8-64 blade - Extended Fabrics is not supported on this blade.
- Brocade 8000 - Extended Fabrics is not supported on this platform.

## Long distance link modes

Use the `portCfgLongDistance` command to support long distance links and to allocate sufficient numbers of full size frame buffers on a particular port. Changes made by this command are persistent across switch reboots and power cycles. This command supports the following long-distance link modes:

- **Static Mode (LO)** - LO is the normal (default) mode for a port. It configures the port as a regular port. A total of 20 full-size frame buffers are reserved for data traffic, regardless of the port's operating speed; therefore, the maximum supported link distance is up to 10 km at 1 Gbps, up to 5 km at 2 Gbps, up to 2 km at 4 Gbps, and up to 1 km at 8 Gbps.
- **Static Mode (LE)** - LE configures an E\_Ports distance greater than 5 km and up to 10 km. LE does not require an Extended Fabrics license. The baseline for the calculation is one credit per km at 2 Gbps. This yields the following values for 10 km:
  - 5 credits per port at 1 Gbps.
  - 10 credits per port at 2 Gbps.
  - 20 credits per port at 4 Gbps.
  - 40 credits per port at 8 Gbps.
- **Dynamic Mode (LD)** - LD calculates BB credits based on the distance measured during port initialization. Brocade switches use a proprietary algorithm to estimate distance across an ISL. The estimated distance is used to determine the BB credits required in LD (Dynamic) extended link mode based on a maximum Fibre Channel payload size of 2,112. You can place an upper limit on the calculation by providing a `desired_distance` value. Fabric OS confines user entries to no larger than what it has estimated the distance to be. When the measured distance is more than `desired_distance`, the `desired_distance` (the smaller value) is used in the calculation.
- **Static Long-Distance Mode (LS)** - LS calculates a static number of BB credits based only on a user-defined `desired_distance` value. LS mode also assumes that all FC payloads are 2112 bytes. Specify LS mode to configure a static long distance link with a fixed buffer allocation greater than 10 km. Up to a total of 1452 full-size frame buffers are reserved for data traffic, depending on the specified `desired_distance` value.

---

### NOTE

Long distance modes L0.5, L1, and L2 are not supported on Fabric OS v6.x.

---

## Configuring an extended ISL

Before configuring an extended ISL, ensure that the following conditions are met:

- The ports on both ends of the ISL are operating at the same port speed, and can be configured at the same distance level without compromising local switch performance.

---

### NOTE

A long-distance link also can be configured to be part of a trunk group. Two or more long-distance links in a port group form a trunk group when they are configured for the same speed, the same distance level, and their link distances are nearly equal. For information on trunking concepts and configurations, refer to [Chapter 19, “Managing Trunking Connections”](#).

---

- Only qualified Brocade SFPs are used. Only Brocade-branded or certain Brocade-qualified SFPs are supported on the 8 Gbps platforms.

1. Connect to the switch and log in using an account assigned to the admin role.
2. Enter the **switchDisable** command.
3. Enter the **configure** command to set the switch fabric-wide configurations. You can set the following fabric-wide settings:

(\* = multiplication symbol)

Field	Type	Default	Range
Domain	Number	1	Varies
R_A_TOV	Number	1000	E_D_TOV * 2 to 120000
E_D_TOV	Number	2000	1000 to R_A_TOV/2
WAN_TOV	Number	0	0 to R_A_TOV/4
MAX_HOPS	Number	7	7 to 19

4. For 8 Gbps platforms only, enter the **portCfgFillword** command to set ARB as the fill word.

```
portcfgfillword [slot/]port, mode
```

The *mode* parameter in this command must be set to 1 if the *vc\_translation\_link\_init* parameter in the **portCfgLongDistance** command (in the next step) is set to 1.

5. Enter the **portCfgLongDistance** command.

```
portcfglongdistance [slot/]port [distance_level] [vc_translation_link_init] [desired_distance]
```

6. Repeat [step 5](#) and [step 4](#) for the remote extended ISL port. Both the local and remote extended ISL ports must be configured to the same distance level. When the connection is initiated, the fabric will reconfigure.

### Example

The following example configures slot 1, port 2 to support a 100 km link in LS mode and be initialized using the extended link initialization sequence. This example is for an 8 Gbps platform.

```
switch:admin> portcfgfillword 1/2 1
switch:admin> portcfglongdistance 1/2 LS 1 100
Reserved Buffers =          406
Warning: port may be reserving more credits depending on port speed.
switch:admin> portshow 1/2
portName:
portHealth: OFFLINE
```

```

Authentication: None
portDisableReason: None
portCFlags: 0x1
portFlags: 0x1    PRESENT U_PORT
portType: 17.0
portState: 2      Offline
Protocol: FC
portPhys: 2      No_Module
portScn: 0
port generation number: 0
portId: 010200
portIfId: 4312003b
portWwn: 20:02:00:05:1e:94:0f:00
portWwn of device(s) connected:

Distance: static (desired = 100 Km)
portSpeed: N8Gbps

LE domain: 0
FC Fastwrite: OFF
Interrupts:      0          Link_failure: 0          Frjt:      0
Unknown:         0          Loss_of_sync: 0        Fbsy:      0
Lli:             0          Loss_of_sig: 3
Proc_rqrd:      5          Protocol_err: 0
Timed_out:      0          Invalid_word: 0
Rx_flushed:     0          Invalid_crc: 0
Tx_unavail:     0          Delim_err: 0
Free_buffer:    0          Address_err: 0
Overrun:        0          Lr_in:      0
Suspended:     0          Lr_out:     0
Parity_err:     0          Ols_in:     0
2_parity_err:  0          Ols_out:    0
CMI_bus_err:   0

```

## Enabling long distance when connecting to TDM devices

Use this procedure when connecting to Time-Division Multiplexing (TDM) devices and your Brocade switch has QoS and buffer credit recovery enabled.

1. Connect to the switch and log in using an account assigned to the admin role.
2. Disable QoS.

```
switch:admin> portcfgqos --disable [slot/]port
```

If you do not disable QoS, after the second or third Link Reset (LR), ARBS display.

3. Disable the credit recovery; credit recovery is not compatible with the IDLE mode. If you do not disable the credit recovery, it continues to perform a link reset.

```
switch:admin> portcfgcreditrecovery --disable [slot/]port
```

4. Configure the port to support long-distance links.

```
switch:admin> portcfglongdistance [slot/]port,LS,0,100
```

## Buffer credit management

Buffer-to-buffer credit management affects performance over distances; therefore, allocating a sufficient number of buffer credits for long-distance traffic is essential to performance. To prevent a target device (either host or storage) from being overwhelmed with frames, the Fibre Channel architecture provides flow control mechanisms based on a system of credits.

Each of these credits represents the ability of the device to accept additional frames. If a recipient issues no credits to the sender, no frames can be sent. Pacing the transport of subsequent frames on the basis of this credit system helps prevent the loss of frames and reduces the frequency of entire Fibre Channel sequences needing to be retransmitted across the link.

Because the number of buffer credits available for use within each port group is limited, configuring buffer credits for extended links may affect the performance of the other ports in the group used for core-to-edge connections. You must balance the number of long-distance ISL connections and core-to-edge ISL connections within a switch. Configuring long-distance ISLs between core and edge switches is possible, but is not a recommended practice.

With the exception of 3xxx series and earlier switches, all switch ports provide protection against buffer depletion through buffer limiting. A buffer-limited port reserves a minimum of eight buffer credits, allowing the port to continue to operate rather than being disabled due to a lack of buffers. The eight buffer minimum allows 4 and 8 Gbps speeds over distances within most data centers.

Buffer-limited operations are supported for the LS and LD extended ISL modes only. For LD, distance in kilometers is the smaller of the distance measured during port initialization versus the desired distance value. For LS, distance in kilometers is always the desired distance value.

### Buffer-to-Buffer flow control

Buffer-to-Buffer (BB) credit flow control is implemented to limit the amount of data that a port may send based on the number and size of the frames sent from that port. Buffer credits represent finite physical port memory. Within a fabric, each port may have a different number of BB credits. Within a connection, each side may have a different number of BB credits.

Buffer-to-Buffer flow control is flow control between adjacent ports in the I/O path, for example, transmission control over individual network links. A separate, independent pool of credits is used to manage Buffer-to-Buffer flow control. Buffer-to-Buffer flow control works by a sending port using its available credit supply and waiting to have the credits replenished by the port on the opposite end of the link. These BB credits are used by Class 2 and Class 3 service and rely on the Fibre Channel Receiver-Ready (R\_RDY) control word to be sent by the receiving link port to the sender. The rate of frame transmission is regulated by the receiving port based on the availability of buffers to hold received frames.

Upon arrival at a receiver, a frame goes through several steps. It is received, deserialized, decoded, and is stored in a receive buffer where it is processed by the receiving port. If another frame arrives while the receiver is processing the first frame, a second receive buffer is needed to hold this new frame. Unless the receiver is capable of processing frames as fast as the transmitter is capable of sending them, it is possible for all of the receive buffers to fill up with received frames. At this point, if the transmitter should send another frame, the receiver will not have a receive buffer available and the frame will be lost. Buffer-to-Buffer flow control provides consistent and reliable frame delivery of information from sender to receiver.

## Optimal buffer credit allocation

The optimal number of buffer credits is determined by the distance (frame delivery time), the processing time at the receiving port, link signaling rate, and the size of the frames being transmitted. As the link speed increases, the frame transmission time is reduced and the number of buffer credits must be increased to obtain full link utilization, even in a short-distance environment.

For each frame that is transferred, the hardware at the other end must acknowledge that the frame has been received before a successful transmission occurs. This requires enough capacity in the hardware to allow continuous transmission of frames on the link, while waiting for the acknowledgement to be sent by the receiver at the other end.

As the distance between switches and the link speed increases, additional buffer credits are required for the ports used for long-distance connections. Distance levels define how buffer credits are allocated and managed for extended ISLs. Buffer credits are managed from a common pool available to a group of ports on a switch. The buffer credit can be changed for specific applications or operating environments, but it must be in agreement among all switches to allow formation of the fabric.

To maintain 100 percent utilization of a 1 Gbps link for 100 km, the sending hardware must have enough resources (BB credits) to keep 106,250 bytes on the link and the receiving hardware must have enough resources to allow the sender to transmit continuously. To theoretically achieve 100 percent utilization of a 1 Gbps link for 100 km, the required number of BB credits ranges from 49 to 1155 depending on the average frame size. When the link speed is increased to 2 Gbps, the required number of BB credits ranges from 98 to 2310. It is not possible for the switch to determine what the frame size is going to be.

### *Considerations for calculating buffer credits*

Following are the considerations for calculating how many ports can be configured for long distance on all Fabric OS v6.x capable switch modules:

- Each port is part of a port group that includes a pool of buffer credits that can be utilized. This is not the same as the port groups used for ISL Trunking.
- Each user port reserves eight buffer credits when online or offline.
- Any remaining buffers can be reserved by any port in the port group.
- When QoS is enabled and the port is online, an additional 14 buffers are allocated to that port.
- The following switches and blades have a limitation of 255 buffers maximum that can be allocated to a port, which corresponds to a distance of ~500 km at 1 Gbps:
  - 4100, 4900, 5000, 7500, 7600
  - FA4-18, FC4-16IP, FR4-18i
  - FC4-16, FC4-32, FC4-48

---

#### **NOTE**

The following switches and blades do not have this limitation: 300, 5100, 5300, 5410, 5424, 5450, 5480, VA-40FC, FC8-16, FC8-32, FC8-48.

---

## Fibre Channel gigabit values reference definition

Before you can calculate the buffer requirement, note the following Fibre Channel gigabit values reference definition:

- 1.0625 for 1 Gbps
- 2.125 for 2 Gbps
- 4.25 for 4 Gbps
- 8.5 for 8 Gbps

## Allocating buffer credits based on full-size frames

Assuming that the frame size is full, one buffer credit allows a device to send one payload up to 2112 bytes (2148 with headers). Assuming that each payload is 2112, you need one credit per 1 km of link length at 2 Gbps (smaller payloads require additional BB credits to maintain link utilization). For information on allocating buffer credits on average size frames, see [“Allocating buffer credits based on average-size frames”](#) on page 449

The final frame size must be a multiple of 4 bytes. If the data (payload) needs to segment, it will be padded with 1 to 3 “fill-bytes” to achieve an overall 4-byte frame alignment. The standard frame header size is 24 bytes. If applications require extensive control information, up to 64 additional bytes (for a total of an 88-byte header) can be included. Because the total frame size cannot exceed the maximum of 2,148 bytes, the additional header bytes will subtract from the data segment size by as much as 64 bytes (per frame). This is why the maximum data (payload) size is 2,112 (because  $[2,112 - 64] = 2,048$ , which is 2 kbs of data). The final frame, after it is constructed, is passed through the 8-byte to 10-byte conversion process.

The following table describes Fibre Channel data frames.

**TABLE 91** Fibre Channel data frames

Fibre Channel Frame fields	Field size	
Start of frame	4 bytes	32 bits
Standard frame header	24 bytes	192 bits
Data (payload)	0 - 2,112 bytes	0 - 16,896 bits
CRC	4 bytes	32 bits
End of frame	4 bytes	32 bits
<b>Total (Nbr bits/frame)</b>	<b>36 - 2,148 bytes</b>	<b>288 - 17,184 bits</b>

You can allocate buffer credits based on distance using the **portCfgLongDistance** command. The [Long distance link modes](#) allow you to select the Dynamic mode (LD) or the Static Long-distance mode (LS) to calculate the BB credits.

For LD, the estimated distance in kilometers is the smaller of the distance measured during port initialization versus the *desired\_distance parameter*, which is required when a port is configured as an LD or an LS mode link. It is best practice to use LS over LD. The assumption of Fibre Channel payloads consistently being 2,112 bytes is not realistic in practice. To gain the proper number of BB credits using the LS mode, there must be enough BB credits available in the pool because Fabric OS will check before accepting a value.

**NOTE**

The **portCfgLongDistance** command's *desired\_distance* parameter is the upper limit of the link distance and is used to calculate buffer availability for other ports in the same port group. When the measured distance exceeds the value of *desired\_distance*, this value is used to allocate the buffers. In this case, the port operates in degraded mode instead of being disabled due to insufficient buffers. In LS mode, the actual link distance is not measured; instead, the *desired\_distance* value is used to allocate the buffers required for the port.

Refer to the data in [Table 92](#) on page 451 and [Table 93](#) on page 452 to get the total ports in a switch or blade, number of user ports in a port group, and the unreserved buffer credits available per port group. The values reflect an estimate, and may differ from the supported values in [Table 93](#).

1. Determine the desired distance in kilometers of the switch-to-switch connection. This example uses 50 km.
2. Determine the speed that you will use for the long-distance connection. This example uses 2 Gbps.
3. Use one of the following formulas to calculate the reserved buffers for distance:
  - If QoS is enabled:  
 $(Reserved\ Buffer\ for\ Distance\ Y) = (X * LinkSpeed / 2) + 6 + 14$
  - If QoS is not enabled:  
 $(Reserved\ Buffer\ for\ Distance\ Y) = (X * LinkSpeed / 2) + 6$

Where:

*X* = the distance determined in step 1 (in kilometers).

*LinkSpeed* = the speed of the link determined in step 2.

6 = the number of buffer credits reserved for Fabric Services, Multicast, and Broadcast traffic. This is a static number.

14 = the number of buffer credits reserved for QoS. This is a static number.

Based on the answers provided in steps 1 and 2, insert the numbers into the formula. The formula should read as follows:

$(50\ km * 2\ Gbps / 2) + 6 = 56\ buffers$ , which is the number of buffers reserved for distance

Below are additional examples using different speeds all based on a distance of 50 km. The distances and speeds are variables that can change based on how your network is set up:

- If you have a distance of 50 km at 1 Gbps then,  $(50\ km * 1\ Gbps / 2) + 6 = 31\ buffers$
- If you have a distance of 50 km at 2 Gbps then,  $(50\ km * 2\ Gbps / 2) + 6 = 56\ buffers$
- If you have a distance of 50 km at 4 Gbps then,  $(50\ km * 4\ Gbps / 2) + 6 = 106\ buffers$
- If you have a distance of 50 km at 8 Gbps then,  $(50\ km * 8\ Gbps / 2) + 6 = 206\ buffers$

**Example :** Consider the Brocade 300, which has a single 24-port port group and a total of 676 buffer credits for that port group

The maximum remaining number of buffer credits for the port group, after each port reserves its eight buffer credits, is:

$676 - (24 * 8) = 484\ unreserved\ buffer\ credits$

Where:



24 = the number of user ports in a port group retrieved from [Table 92](#) on page 451.

8 = the number of reserved credits for each user port.

676 = the number of buffer credits available in the port group.

If you allocate the entire 484 + 8 (8 for the reserved buffers already allocated to that user port) = 492 buffers to a single port, you can calculate the maximum single port extended distance supported:

$$[\text{Maximum Distance } X \text{ in km}] = (\text{BufferCredits} + 6) * 2 / \text{LinkSpeed}$$

$$498 \text{ km} = (492 + 6 \text{ buffers for Fabric Services}) * 2 / 2 \text{ Gbps}$$

How many 50 km ports can you configure?

If you have a distance of 50 km at 8 Gbps then,  $484 / (206 - 8) = 2$  ports

The numbers used are: 484, which equals the total number of unreserved buffer credits, 206, which equals buffer credits needed for 50 km @ 8 Gbps (calculated previously), and 8, which equals number of reserved buffer credits already allocated to that port. The floor of the resulting number is taken because fractions of a port are not allowed.

If you have a distance of 50 km at 1 Gbps then,  $484 / (31 - 8) = 21$  ports

## Allocating buffer credits based on average-size frames

In cases where the frame size is average, for example 1024 bytes, you must allocate twice the buffer credits or give twice the distance in the long-distance LS configuration mode. Refer to the [Fibre Channel gigabit values reference definition](#) to get an approximation of the calculated number of buffer credits.

1. Use the following formula to calculate value for the *desired\_distance* needed for Fabric OS to determine the number of BB credits to allocate:

$$\text{desired\_distance} = \text{roundup} [(\text{real\_estimated\_distance} * 2112) / \text{average\_payload\_size}]$$

Where *average\_payload\_size* = 1024 bytes

This example uses 100 km for the real estimated distance.

$$\text{desired\_distance} = \text{roundup} [(100 * 2112) / 1024] = 207$$

When configuring the LS mode with the **portCfgLongDistance** command, enter a *desired\_distance* value of 207 for an actual 100 km link connected to an 8 Gbps E\_Port. This causes Fabric OS to allocate the correct number of BB credits.

2. Determine the speed that you will use for the long-distance connection. This example uses 8 Gbps.
3. Look up the *data\_rate* value for the speed of the connection. See [“Fibre Channel gigabit values reference definition”](#) on page 447 to determine the *data\_rate* value.

For 8 Gbps, the *data\_rate* is 8.5

4. Use the following formula to calculate the number of buffer-to-buffer credits to allocate:

$$\text{BB credits} = \text{roundup} [\text{desired\_distance} * (\text{data\_rate} / 2.125)]$$

Using the values for *desired\_distance* and *data\_rate* from [step 1](#) and [step 3](#), the value for BB credits is calculated as follows:

$$\text{BB credits} = \text{roundup} [(207 * 8.5) / 2.125] = 828$$

**NOTE**

This formula does not work with LD mode because LD mode checks the distance and limits the estimated distance to the real value of 100 km. LS mode allows for the necessary *desired\_distance* based on the data size entered, regardless of the distance.

If buffer credit recovery is enabled, Fabric OS supports a BB\_SC\_N range of 1 to 15; therefore, it is impossible for the *desired\_distance* to be more than the number of BB credits available in the pool as determined by the calculations above. The BB credit recovery supported distance is well within the range of all possible connections. An estimated distance of 32,768 is considerably higher than the available BB credits and only lower values of *desired\_distance* are permitted by Fabric OS.

## Allocating buffer credits for F\_Ports

The default configured F\_Port buffer credit is fixed at eight buffers. You can use the **portCfgFPortBuffers** command to configure a given port with the specified number of buffers. Note that in the sample commands provided in the following procedure, 12 buffers are configured for an F\_Port.

1. Connect to the switch and log in using an account assigned to the admin role.
2. Enter the **portCfgFPortBuffers** command.

```
switch:admin> portcfgfportbuffers --enable 2/44 12
```

To disable the port buffer configuration and return to the default buffer allocation:

```
switch:admin> portcfgfportbuffers --disable 2/44
```

**NOTE**

The configured number of buffers for the given port is stored in the configuration database and is persistent across reboots. The F\_Port buffer feature does not support EX\_Port, Port Mirroring, Long-Distance, L\_Port, Fast Write, QoS, and Trunk Area enabled ports.

## Displaying the remaining buffers in a port group

1. Connect to the switch and log in using an account assigned to the admin role.
2. Enter the **portBufferShow** command.

```
switch:admin> portbuffershow 17
```

User Port	Port Type	Lx Mode	Max/Resv Buffers	Buffer Usage	Needed Buffers	Link Distance	Remaining Buffers
16		-	-	0	-	-	
17	E	L1	-	54	54	50km	
18		-	-	0	-	-	
19		-	-	0	-	-	54

## Buffer credits for each switch model

Table 92 shows the total ports in a switch or blade, number of user ports in a port group, and the unreserved buffer credits available per port group.

**TABLE 92** Buffer credits

Switch/blade model	Total FC ports (per switch/blade)	User port group size	Unreserved buffers (per port group)
300	24	24	484
4100/5000	32	32	744
4900	64	16	584
5100	40	40	1692
5300	80	16	292
5410	12	12	580
5424	24	24	484
5450	26	26	468
5480	24	24	484
7500	16	8	377
7600	16	8	404
7800	16	16	408
VA-40FC	40	40	1692
Brocade Encryption Switch	32	16	1392
FA4-18	16	8	404
FC4-16	16	16	584
FC4-16IP	8	8	616
FC4-32	32	16	624
FC4-48	48	24	560
FC8-16	16	16	1292 / 1388
FC8-32	32	16	1292 / 1636
FC8-48	48	24	1228 / 1572
FR4-18i	16	8	377
FS8-18	16	8	1604
FX8-24	12	12	1060

For the FC8-x blades, the first number in the Unreserved buffers column designates the number of unreserved buffers per port group in Brocade DCX and DCX-4S platforms; the second number designates the unreserved buffers in a Brocade 48000 director. For example, for the FC8-48, 1228 designates the number of unreserved buffers per port group and 1324 number designates the number in a Brocade 48000 director. Additional buffers are available with the Brocade 48000 director because of fewer buffers allocated for back-end port connections. Implementing extended fabrics between Brocade 2xxx switches and switches running any Fabric OS v6.x is not supported.

## Maximum configurable distances for Extended Fabrics

Table 93 shows the maximum supported extended distances (in kilometers) that can be configured for one port on a specific switch or blade at different speeds.

**TABLE 93** Configurable distances for Extended Fabrics

Switch/blade model	Maximum distances (km) that can be configured assuming 2112 Byte Frame Size			
	1 Gbps	2 Gbps	4 Gbps	8 Gbps
300	972	486	243	121
4100/5000	500	250	100	N/A
4900	500	250	100	N/A
5100	3388	1694	847	423
5300	588	294	147	73
5410	1164	582	291	145.5
5424	972	486	243	121.5
5450	940	470	235	117.5
5480	972	486	243	121.5
7500	500	250	100	N/A
7600	500	250	100	N/A
7800	822	410	205	102
VA-40FC	3388	1694	847	423
Brocade Encryption Switch	2784	1392	696	348
FA4-18	500	250	100	N/A
FC4-16	500	250	100	N/A
FC4-16IP	500	250	100	N/A
FC4-32	500	250	100	N/A
FC4-48	500	250	100	N/A
FC8-16	2589 / 2781	1294 / 1390	647 / 695	323 / 347
FC8-32	2589 / 3277	1294 / 1638	647 / 819	323 / 409
FC8-48	2461 / 3149	1230 / 1574	615 / 787	307 / 393
FC10-6	See the Note at the end of this table for information about this blade.			
FR4-18i	500	250	100	N/A
FS8-18	3208	1604	802	401
FX8-24	2125	1062	531	265

### NOTE

The 10 Gbps FC10-6 blade has two port groups of three ports each. For extended ISLs, all buffers available to a group are used to support one port at up to 100 km.

**NOTE**

QoS requires an additional 14 buffer credits per active port so maximum supported distances may be lower.

To get an estimated maximum equally distributed distance for  $n$  number of ports at a particular ("X") speed, divide the 1-port maximum distance of the switch at X speed by  $n$ . For example, for three ports running at 2 Gbps on a 300 switch, the maximum equally distributed distance is calculated as  $486 / 3 = 164$  km.

## Buffer credit recovery

Buffer credit recovery does not require configuration. This feature allows links to recover after R\_RDYs are lost when the credit recovery logic is enabled. The buffer credit recovery feature also maintains performance. If a credit is lost, a recover attempt is initiated. During link reset, the frame and credit loss counters are reset without performance degradation.

This feature is only supported on E\_Ports that are configured for long distance and are connected between the following switch or blade models:

- Brocade 300, 5100, 5300, 5410, 5424, 5450, 5480, VA-40FC
- FC8-16, FC8-32, FC8-48

If a long-distance E\_Port from one of these supported switches or blades is connected to any other switch or blade type, the buffer credit recovery feature is disabled.

Virtual E\_Ports and Virtual EX\_Ports do not support long distance. The buffer credit recovery feature is enabled for the following flow control modes: Normal, Virtual Channel (VC), and Extended VC modes.

An FC\_Port that supports BB\_Credit recovery maintains the following BB\_Credit recovery values:

- BB\_SC\_N is the log2 of BB\_Credit recovery modules.
- BB\_RDY\_N counts the number of R\_RDY primitives received modulo  $2^{BB\_SC\_N}$ .
- BB\_FRM\_N counts the number of frames received modulo  $2^{BB\_SC\_N}$ .



# Using the FC-FC Routing Service

---

## In this chapter

- FC-FC routing service overview . . . . . 455
- Integrated Routing . . . . . 457
- Fibre Channel routing concepts . . . . . 457
- Setting up the FC-FC routing service . . . . . 464
- Backbone fabric IDs . . . . . 466
- FCIP tunnel configuration . . . . . 467
- Inter-fabric link configuration . . . . . 468
- FC Router port cost configuration . . . . . 471
- EX\_Port frame trunking configuration . . . . . 474
- LSAN zone configuration . . . . . 477
- Proxy PID configuration . . . . . 489
- Fabric parameter considerations . . . . . 489
- Inter-fabric broadcast frames . . . . . 490
- Resource monitoring . . . . . 491
- FC-FC Routing and Virtual Fabrics . . . . . 492
- Upgrade and downgrade considerations for FC-FC routing . . . . . 495
- Displaying the range of output ports connected to xlate domains . . . . . 496

## FC-FC routing service overview

The FC-FC routing service provides Fibre Channel routing (FCR) between two or more fabrics without merging those fabrics. A Fibre Channel router (*FC router*) is a switch running the FC-FC routing service. The FC-FC routing service can be simultaneously used as an FC router and as a SAN extension over wide area networks (WANs) using FCIP. FCR supports backbone-to-edge routing, allowing devices in the backbone to communicate with devices on the edge fabric.

For example, using FCR you can share tape drives across multiple fabrics without the administrative problems, such as change management, network management, scalability, reliability, availability, and serviceability, that might result from merging the fabrics.

You can set up QoS traffic prioritization over FC routers. See [“QoS: SID/DID traffic prioritization”](#) on page 403 for information about QoS and instructions for setting traffic prioritization over an FC router.

FCR supports interoperability with some versions of M-EOS. For more information about M-EOS interoperability support, see [Appendix A, “M-EOS Migration Path to Fabric OS”](#).

## Supported platforms for Fibre Channel routing

Fibre Channel routing is supported on the following platforms:

- Brocade DCX and DCX-4S (FC8-16, FC8-32, FC8-48, FC8-64, FS8-18, FX8-24, or FR4-18i blade)
- Brocade 5100 switch
- Brocade 5300 switch
- Brocade VA-40FC switch
- Brocade 7500 Extension Switch
- Brocade 7800 Extension Switch
- Brocade 48000 director, using the FR4-18i blade
- Brocade Encryption Switch

For the Brocade 48000 director, EX\_Ports are supported only on the FR4-18i blade and are *not* supported on 8-Gbps port blades.

For the Brocade DCX and DCX-4S, note the following restrictions:

- EX\_Ports are supported only on the FR4-18i, FX8-24, and 8-Gbps *port* blades. Ports on the 8-Gbps *core* blade cannot be configured as EX\_Ports.
- EX\_Ports on 8-Gbps port blades and EX\_Ports on the FR4-18i blade cannot exist in the same chassis; however, EX\_Ports on 8-Gbps port blades and VEX\_Ports *can* be online at the same time in the same chassis.
- The Brocade DCX and DCX-4S have a limit of 128 EX\_Ports for each chassis.

Fibre Channel routing on the Brocade 5100, 5300, VA-40FC, 7800, Brocade Encryption Switch, and on the 8-Gbps port blades of the Brocade DCX and DCX-4S require an Integrated Routing license. See [“Integrated Routing”](#) on page 457 for additional information about the Integrated Routing feature.

## Supported configurations

In an edge fabric that contains a mix of administrative domain (AD)-capable switches and switches that are not aware of AD, the FC router must be connected directly to an AD-capable switch. For more information, see [“Use of Admin Domains with LSAN zones and FCR”](#) on page 477.

You can use SANtegrity to configure M-Series switches connecting to a B-Series router. For more information, refer to [Chapter 14, “Interoperability for Merged SANs”](#).

The supported configurations are:

- FC router connected to a Brocade nonsecured edge fabric.
- FC router connected to a Brocade secured edge fabric.
- FC router connected to a McDATA Open Mode edge fabric.
- FC router connected to a McDATA Fabric Mode edge fabric.
- FC router connected to Brocade secured and nonsecured fabrics with EX\_Port trunking enabled.
- FC router interoperating with older FC routers (XPath v7.4.x, Fabric OS v5.1 and later).

McDATA Enterprise OS switches cannot exist in the backbone fabric.



---

**NOTE**

In configurations with two backbones connected to the same edge fabric, routing is not supported between edge fabrics that are not directly attached to the same backbone. Routing over multiple backbones is a multi-hop topology and is not allowed.

---

## Integrated Routing

Integrated Routing is a licensed feature that allows 8-Gbps FC ports to be configured as EX\_Ports (or VEX\_Ports) supporting Fibre Channel routing. This license eliminates the need to add an FR4-18i blade to the Brocade DCX and DCX-4S, or to use the Brocade 7500 for FC-FC routing purposes. Using 8-Gbps ports for Fibre Channel routing provides double the bandwidth for each FCR connection (when connected to another 8-Gbps-capable port).

You need an Integrated Routing license for the following:

- Brocade DCX and DCX-4S (FC8-16, FC8-32, FC8-48, FC8-64, FS8-18, and FX8-24 blades)
- Brocade 5100 switch
- Brocade 5300 switch
- Brocade VA-40FC switch
- Brocade 7800 Extension Switch
- Brocade Encryption Switch

You do not need a license for EX\_Ports on the Brocade 7500 Extension Switch or FR4-18i blade.

Enabling the Integrated Routing license and capability does *not* require a switch reboot.

For the Brocade DCX and DCX-4S, if you do not have an Integrated Routing license, you cannot use EX\_Ports on the 8-Gbps port blades; you can, however, use EX\_Ports on the FR4-18i blade without a license.

---

**NOTE**

You cannot use EX\_Ports on the FR4-18i blade and Integrated Routing in the same chassis.

---

Integrated Routing is not supported on 8-Gbps blades in the Brocade 48000.

## Fibre Channel routing concepts

Fibre Channel routing introduces the following concepts:

- Fibre Channel router (FC router)  
A switch running the FC-FC routing service. See [“Supported platforms for Fibre Channel routing”](#) on page 456 for a list of platforms that can be FC routers.
- EX\_Port, VEX\_Port  
An EX\_Port and VEX\_Port function similarly to an E\_Port and VE\_Port respectively, but terminate at the switch and do not propagate fabric services or routing topology information from one edge fabric to another. See the *Fibre Channel over IP Administrator’s Guide* for details about VE\_Ports.

- **Edge fabric**  
An edge fabric is a Fibre Channel fabric with targets and initiators connected through the supported platforms by using an EX\_Port or VEX\_Port.
- **Backbone fabric**  
A backbone fabric is an intermediate network that connects one or more edge fabrics. In a SAN, the backbone fabric consists of at least one FC router and possibly a number of Fabric OS-based Fibre Channel switches (see [Figure 70](#) on page 460).
- **Inter-fabric link (IFL)**  
The link between an E\_Port and EX\_Port, or VE\_Port and VEX\_Port, is called an *inter-fabric link* (IFL). You can configure multiple IFLs from an FC router to an edge fabric.

[Figure 68](#) shows a metaSAN consisting of three edge fabrics connected through a Brocade DCX with inter-fabric links.

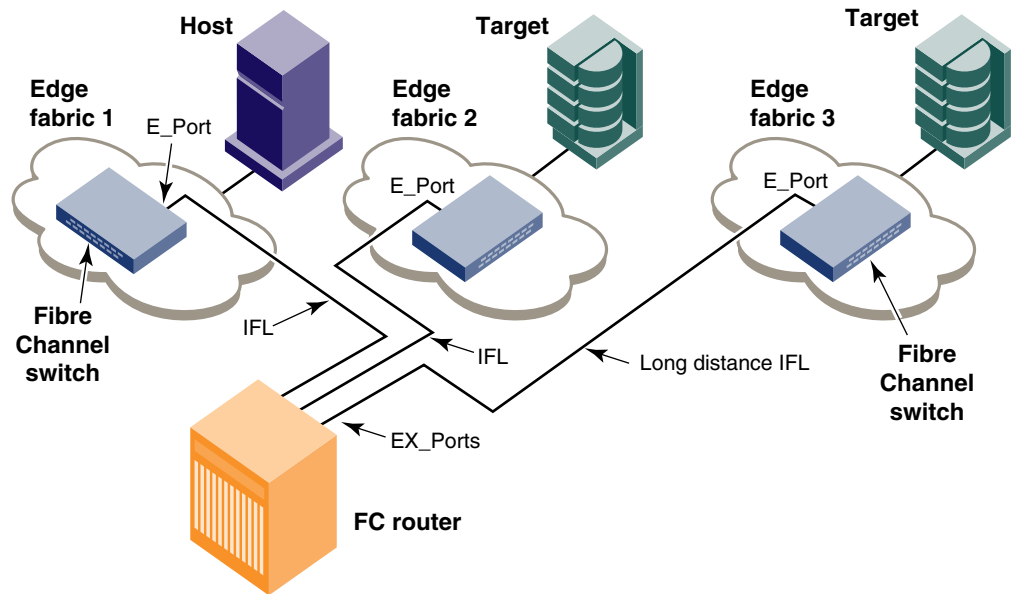
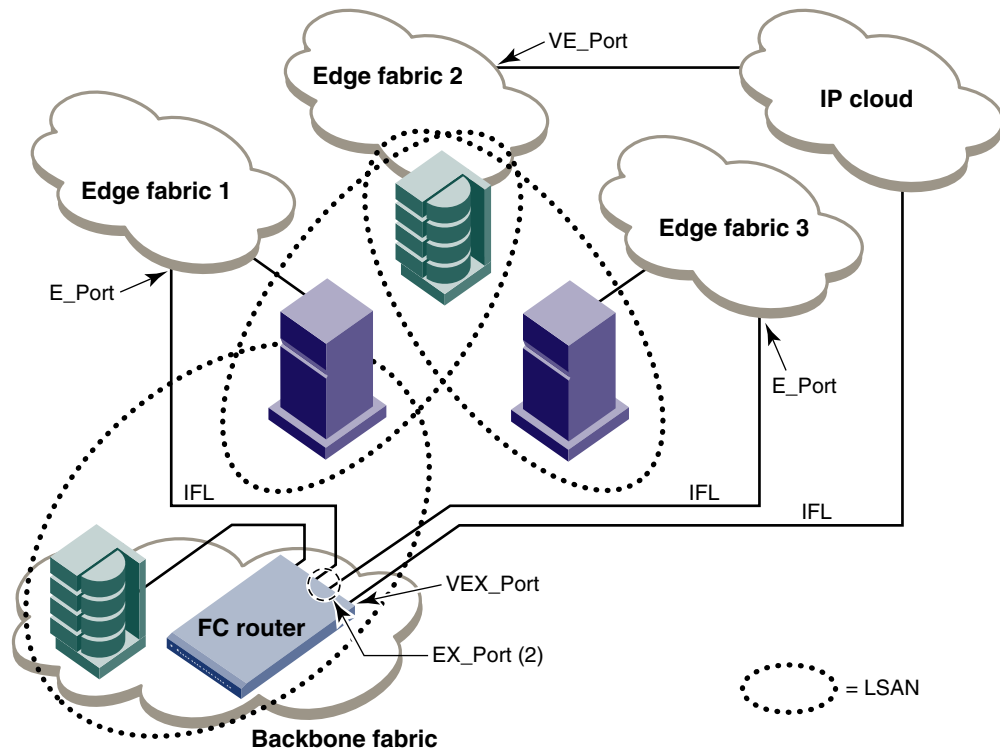

**FIGURE 68** A metaSAN with inter-fabric links

- **Logical SANs (LSANs)**  
An LSAN is defined by zones in two or more edge or backbone fabrics that contain the same devices. You can create LSANs that span fabrics. These LSANs enable Fibre Channel zones to cross physical SAN boundaries without merging the fabrics while maintaining the access controls of zones.

An LSAN device can be a *physical device*, meaning that it physically exists in the fabric, or it can be a *proxy device*.

[Figure 69](#) on page 459 shows a metaSAN with a backbone consisting of one FC router connecting hosts in edge fabrics 1 and 3 with storage in edge fabric 2 and the backbone fabric through the use of LSANs. Three LSAN zones allow device sharing between the backbone fabric and Edge Fabric 1, between Edge Fabric 1 and Edge Fabric 2, and between Edge Fabric 2 and Edge Fabric 3.



**FIGURE 69** A metaSAN with edge-to-edge and backbone fabrics and LSAN zones

- Proxy device

A proxy device is a virtual device imported into a fabric by a Fibre Channel router, and represents a real device on another fabric. It has a name server entry and is assigned a valid port ID. When a proxy device is created in a fabric, the real Fibre Channel device is considered to be imported into this fabric. The presence of a proxy device is required for inter-fabric device communication. See “Proxy devices” on page 461 for additional information about proxy devices.

- Proxy PID

A proxy PID is the port ID (PID) of the proxy device. The proxy device appears to the fabric as a real Fibre Channel device, has a name server entry, and is assigned a valid port ID. The port ID is relevant only on the fabric in which the proxy device has been created.

- Fabric ID (FID)

Every EX\_Port and VEX\_Port uses the fabric ID (FID) to identify the fabric at the opposite end of the inter-fabric link. The FID for every edge fabric must be unique from the perspective of each backbone fabric.

- If multiple EX\_Ports (or multiple VEX\_Ports) are attached to the same edge fabric, they must be configured with the same FID.
- If EX\_Ports and VEX\_Ports are attached to different edge fabrics, they must be configured with a unique FID for each edge fabric.

If two different backbone fabrics are connected to the same edge fabric, the backbone fabric IDs must be different, but the edge fabric IDs must be the same. If you configure the same fabric ID for two backbone fabrics that are connected to the same edge fabric, a RASLog message displays a warning about fabric ID overlap.

**NOTE**

Backbone fabrics that share connections to the same edge fabrics must have unique backbone fabric IDs.

- MetaSAN

A metaSAN is the collection of all SANs interconnected with Fibre Channel routers.

A simple metaSAN can be constructed using an FC router to connect two or more separate fabrics. Additional FC routers can be used to increase the available bandwidth between fabrics and to provide redundancy.

Figure 70 shows a metaSAN consisting of a host in Edge SAN 1 connected to storage in Edge SAN 2 through a backbone fabric connecting two FC routers.

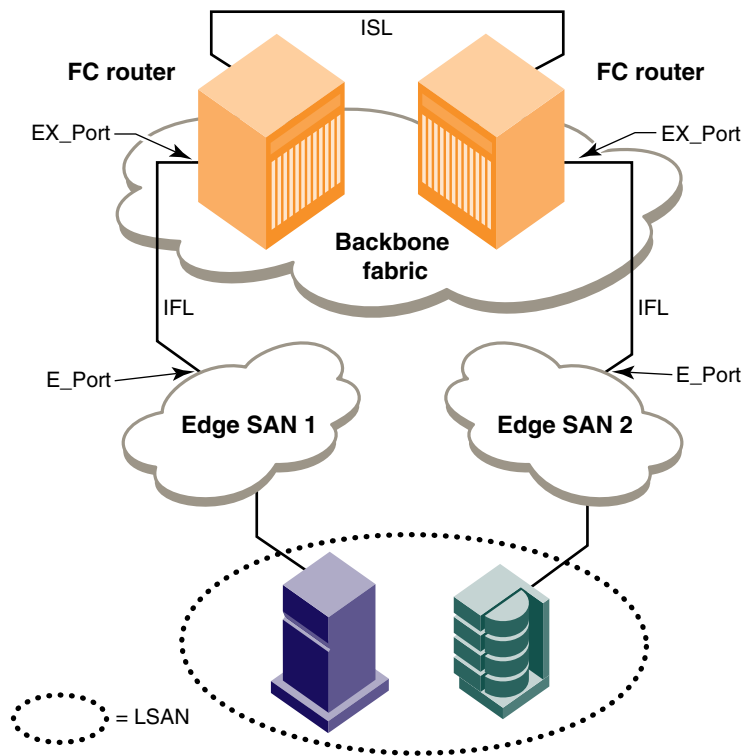

**FIGURE 70** Edge SANs connected through a backbone fabric

- Phantom domains

A phantom domain is a domain emulated by the Fibre Channel router. The FC router can emulate two types of phantom domains: front phantom domains and translate phantom domains. For detailed information about phantom domains, see “Phantom domains” on page 462.

## Proxy devices

An FC router achieves inter-fabric device connectivity by creating proxy devices (hosts and targets) in attached fabrics that represent real devices in other fabrics. For example, a host in Fabric 1 can communicate with a target in Fabric 2 as follows:

- A proxy target in Fabric 1 represents the real target in Fabric 2.
- Likewise, a proxy host in Fabric 2 represents the real host in Fabric 1.

The host discovers and sends Fibre Channel frames to the proxy target. The FC router receives these frames, translates them appropriately, then delivers them to the destination fabric for delivery to the target.

The target responds by sending frames to the proxy host. Hosts and targets are exported from the edge SAN to which they are attached and, correspondingly, imported into the edge SAN reached through Fibre Channel routing. [Figure 71](#) illustrates this concept.

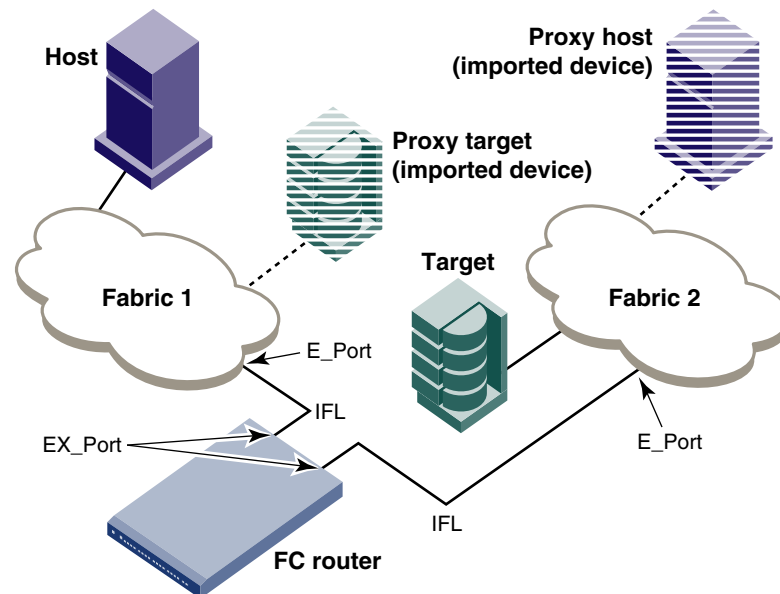

FIGURE 71 MetaSAN with imported devices

## Routing types

The FC-FC routing service provides two types of routing:

- **Edge-to-Edge**  
Occurs when devices in one edge fabric communicate with devices in another edge fabric through one or more FC routers.
- **Backbone-to-Edge**  
Occurs when FC routers connect to a common fabric—known as a backbone fabric—through E\_Ports. A backbone fabric can be used as a transport fabric that interconnects edge fabrics. FC routers also enable hosts and targets in edge fabrics to communicate with devices in the backbone fabric, known as *backbone-to-edge routing*. From the edge fabric's perspective, the backbone fabric is just like any other edge fabric. For the edge fabric and backbone fabric devices to communicate, the shared devices must be presented to each other's native fabric.

To do so, at least one translate phantom domain is created in the backbone fabric. This translate phantom domain represents the entire edge fabric. The shared physical devices in the edge have corresponding proxy devices on the translate phantom domain.

Each edge fabric has one and only one xlate domain to the backbone fabric. The backbone fabric device communicates with the proxy devices whenever it needs to contact the shared physical devices in the edge. The FC-FC Routing Service receives the frames from the backbone switches destined to the proxy devices, and redirects the frames to the actual physical devices. When connected to edge fabrics, the translate phantom domain can never be the principal switch of the backbone fabric. Front domains are not created; rather, only translate phantom domains are created in the backbone fabric.

Devices are exported from the backbone fabric to one or more edge fabrics using LSANs. See [“LSAN zone configuration”](#) on page 477 for more information.

---

**NOTE**

Management Server Platform services and interopmode are not supported in the backbone fabric.

---

### Phantom domains

A phantom domain is a domain emulated by the Fibre Channel router. The FC router can emulate two types of phantom domains: front phantom domains and translate phantom domains.

A *front phantom domain* is a domain that is projected from the FC router to the edge fabric. There is one front phantom domain from each FC router to an edge fabric, regardless of the number of EX\_Ports connected from that router to the edge fabric. Another FC router connected to the same edge fabric projects a different front phantom domain.

The second level of phantom domains is known as a *translate phantom domain*, also referred to as *translate domain* or *xlate domain*. The translate phantom domain is a router virtual domain that represents an entire fabric. Device connectivity can be achieved from one fabric to another—over the backbone or edge fabric through this virtual domain—without merging the two fabrics. The EX\_Ports present translate phantom domains in edge fabrics as being topologically behind the front domains; if the translate phantom domain is in a backbone fabric, then it is topologically present behind the FC router because there is no front domain in a backbone fabric.

If an FC router is attached to an edge fabric using an EX\_Port, it creates xlate domains in the fabric corresponding to the imported edge fabrics with active LSANs defined. If you import devices into the backbone fabric, then an xlate domain is created in the backbone device in addition to the one in the edge fabric.

[Figure 72](#) on page 463 shows a sample physical topology. This figure shows four FC routers in a backbone fabric and four edge fabrics connected to the FC routers.

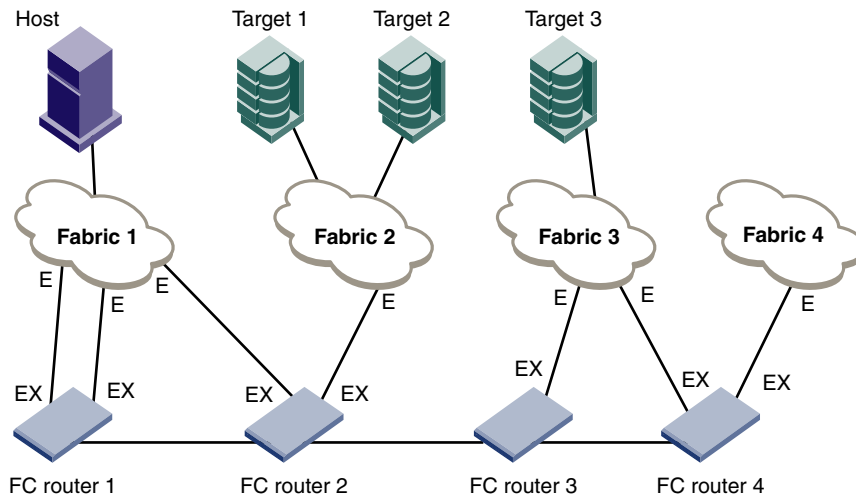

**FIGURE 72** Sample topology (physical topology)

Figure 73 shows a phantom topology for the physical topology shown in Figure 72. In this figure, the dashed lines and shapes represent the phantom topology from the perspective of Fabric 1. Fabrics 2 and 3 also see phantom topologies, but they are not shown in this example. In this figure, note the following:

- Front domain 1 and Front domain 2 are front domains for EX\_Ports connecting to Fabric 1. There is one front domain for each FC router that is connected to Fabric 1.
- Xlate domain 1 and Xlate domain 2 represent Fabrics 2 and 3, respectively. No xlate domain is created for Fabric 4 because there are no LSAN devices in Fabric 4.
- Target 1', Target 2', and Target 3' are proxy devices for Target 1, Target 2, and Target 3, respectively.

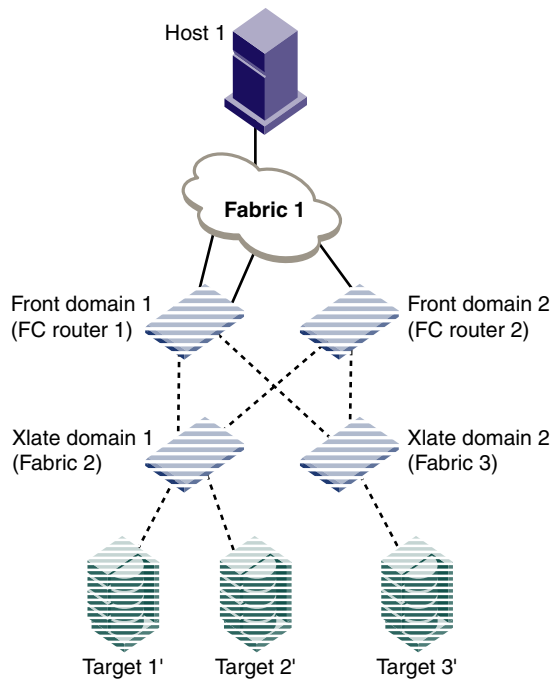

**FIGURE 73** EX\_Port phantom switch topology

All EX\_Ports or VEX\_Ports connected to an edge fabric use the same xlate domain ID number for an imported edge fabric; this value persists across switch reboots and fabric reconfigurations.

If you lose connectivity to the edge fabric because of link failures or the IFL being disabled, xlate domains remain visible. This prevents unnecessary fabric disruptions caused by xlate domains repeatedly going offline and online due to corresponding IFL failures. To remove the xlate domain from the backbone, disable all EX\_Ports or VEX\_Ports through which the xlate domain was created.

The combination of front domains and xlate domains allows routing around path failures, including path failures through the routers. The multiple paths to an xlate domain provide additional bandwidth and redundancy.

There are some differences in how the xlate domain is presented in the backbone fabric. The backbone xlate domains are topologically connected to FC routers and participate in FC-FC routing protocol in the backbone fabric. Front domains are not needed in the backbone fabric. As in the case of an xlate domain in an edge fabric, backbone fabric xlate domains provide additional bandwidth and redundancy by being able to present themselves as connected to single or multiple FC routers with each FC router capable of connecting multiple IFLs to edge fabrics.

Use the `forXlateConfig` command to display or assign a preferred domain ID to a translate domain or, in some scenarios, to prevent the creation of an unnecessary xlate domain. See the *Fabric OS Command Reference* for more details about this command.

## Setting up the FC-FC routing service

To set up the FC-FC Routing Service, perform the following tasks in the order listed:

- Verify that you have the proper setup for FC-FC routing. (See [“Verifying the setup for FC-FC routing”](#) on page 464.)
- Assign backbone fabric IDs. (See [“Backbone fabric IDs”](#) on page 466.)
- Configure FCIP tunnels if you are connecting Fibre Channel SANs over IP-based networks. (See [“FCIP tunnel configuration”](#) on page 467.)
- Configure IFLs for edge and backbone fabric connection. (See [“Inter-fabric link configuration”](#) on page 468.)
- Modify port cost for EX\_Ports, if you want to change from the default settings. (See [“FC Router port cost configuration”](#) on page 471.)
- Configure trunking on EX\_Ports that are connected to the same edge fabric. (See [“EX\\_Port frame trunking configuration”](#) on page 474.)
- Configure LSAN zones to enable communication between devices in different fabrics. (See [“LSAN zone configuration”](#) on page 477.)

See [Chapter 3, “Performing Advanced Configuration Tasks,”](#) for more details about configuration options for Brocade directors.

## Verifying the setup for FC-FC routing

Before configuring a fabric to connect to another fabric, you must perform the following verification checks on the FC router.



1. Log in to the switch or director as admin and enter the **version** command. Verify that Fabric OS v6.4.0 is installed on the FC router as shown in the following example.

```
switch:admin> version
Kernel:      2.6.14.2
Fabric OS:   v6.4.0
Made on:     Fri Jan 22 01:15:34 2010
Flash:       Mon Jan 25 20:53:48 2010
BootProm:    1.0.9
```

2. Perform the following appropriate action based on the hardware model you are configuring:
  - If you are configuring the Brocade 48000 director, enter the **slotShow** command to verify that the FR4-18i blade is present. Proceed to [step 3](#).
  - If you are configuring the Brocade DCX or DCX-4S, enter the **slotShow** command to verify that either the FR4-18i or FX8-24 blade is present or, if configuring EX\_Ports on an 8-Gbps port blade, that the FC8-16, FC8-32, FC8-48, or FC8-64 blade is present. The following example shows slot 2 with the FR4-18i blade and slots 3, 9, 10, and 12 with 8-Gbps port blades enabled. Proceed to [step 3](#).
  - If you are not configuring a Brocade 48000, Brocade DCX, or Brocade DCX-4S platform, then skip to [step 4](#).

```
switch:admin> slotshow -m
```

Slot	Blade Type	ID	Model Name	Status
1	AP BLADE	33	FA4-18	ENABLED
2	<b>AP BLADE</b>	<b>24</b>	<b>FR4-18i</b>	<b>ENABLED</b>
3	<b>SW BLADE</b>	<b>37</b>	<b>FC8-16</b>	<b>ENABLED</b>
4	SW BLADE	39	FC10-6	ENABLED
5	CORE BLADE	52	CORE8	ENABLED
6	CP BLADE	50	CP8	ENABLED
7	CP BLADE	50	CP8	ENABLED
8	CORE BLADE	52	CORE8	ENABLED
9	<b>SW BLADE</b>	<b>37</b>	<b>FC8-16</b>	<b>ENABLED</b>
10	<b>SW BLADE</b>	<b>55</b>	<b>FC8-32</b>	<b>ENABLED</b>
11	UNKNOWN			VACANT
12	<b>SW BLADE</b>	<b>51</b>	<b>FC8-48</b>	<b>ENABLED</b>

See [Chapter 3, “Performing Advanced Configuration Tasks,”](#) for a list of blades and their corresponding IDs.

3. If you are configuring EX\_Ports on the 8-Gbps port blades on the Brocade DCX or DCX-4S (FC8-16, FC8-32, FC8-48, FC8-64, or FX8-24), enter the **licenseShow** command to verify that the Integrated Routing license is installed.

```
switch:admin> licenseshow
S9bddb9SQbTAceeC:
    Fabric license
bzBzRcbcSc0c0SY:
    Remote Fabric license
RyeSzRScycazfT0G:
    Integrated Routing license
```

If the Integrated Routing license is not installed, you must install it, as described in [Chapter 16, “Administering Licensing”](#).

4. Enter the **interopMode** command and verify that Fabric OS switch interoperability with switches from other manufacturers is disabled.

```
switch:admin> interopmode
```

## 21 Backbone fabric IDs

```
InteropMode: Off

usage: InteropMode [0|2|3 [-z McDataDefaultZone] [-s McDataSafeZone]]
0: to turn interopMode off
2: to turn McDATA Fabric mode on
   Valid McDataDefaultZone: 0 (disabled), 1 (enabled)
   Valid McDataSafeZone: 0 (disabled), 1 (enabled)
3: to turn McDATA Open Fabric mode on
```

If InteropMode is on, FC routing is not supported. To turn off interoperability mode, disable the switch and enter the **interopMode 0** command, as described in [“Enabling Brocade Native mode”](#) on page 305.

5. Verify that the Fabric Wide Consistency Policy is not in ‘strict’ mode by issuing the **fddCfg --showall** command. When it is in strict mode, ACL cannot support Fibre Channel routing in the fabric.

```
switch:admin> fddcfg --showall
Local Switch Configuration for all Databases:-
DATABASE - Accept/Reject
-----
SCC - accept
DCC - accept
PWD - accept
Fabric-Wide Consistency Policy :- "SCC:S;DCC"
```

If the Fabric Wide Consistency Policy has the letter “S” in it in the edge fabric or the backbone fabric, do not connect the edge fabric to the FC router. The letter “S” (shown in the preceding sample output) indicates the policy is strict. The fabric-wide policy must be tolerant before you can connect fabrics to the FC router. See [Chapter 7, “Configuring Security Policies”](#) for information about configuring the fabric-wide consistency policy.

## Backbone fabric IDs

If your configuration has only one backbone fabric, then this task is not required because the backbone fabric ID in this situation defaults to a value of 128. The default backbone fabric ID is 1 if Virtual Fabrics is disabled.

All switches in a backbone fabric must have the same backbone fabric ID. You can configure the backbone fabric ID using the **fcrConfigure** command. The backbone fabric ID must be unique from the perspective of every attached edge fabric. Fabric ID changes made on a switch are not propagated to other switches in the backbone fabric. Rather, the backbone fabric administrator is responsible for making sure that all switches in the backbone have the same fabric ID. Because fabric IDs are used heavily by the routing protocol between the Fibre Channel routers, using the wrong fabric ID can affect both edge-to-edge and backbone-to-edge routing.

In addition to ensuring that the backbone fabric IDs are the same within the same backbone, you must make sure that when two different backbones are connected to the same edge fabric, the backbone fabric IDs are different, but the edge fabric ID should be the same. Configuration of two backbones with the same backbone fabric ID that are connected to the same edge is invalid. In this configuration, a RASLog message displays a warning about fabric ID overlap. When two backbone fabrics are *not* connected to the same edge, they can have the same backbone fabric ID.

---

### ATTENTION

In a multi-switch backbone fabric, modification of FID within the backbone fabric will cause disruption to local traffic.

---

## Assigning backbone fabric IDs

1. Log in to the switch or director.
2. Enter the **switchDisable** command if EX\_Ports are online.
3. Enter the **fosConfig --disable fcr** command to disable the FC-FC Routing Service.  
The default state for the FCR is disabled.
4. Enter the **fcrConfigure** command. At the prompt, enter the fabric ID, or press **Enter** to keep the current fabric ID, which is displayed in brackets.
5. Verify the backbone fabric ID is different from that set for edge fabrics.  
Multiple FC routers attached to the same backbone fabric must have the same backbone fabric ID.
6. Enter the **fosConfig --enable fcr** command.
7. Enter the **switchEnable** command.

### Example

```
switch:admin> switchdisable
switch:admin> fosconfig --disable fcr
FC Router service is disabled

switch:admin> fcrconfigure
FC Router parameter set. <cr> to skip a parameter
Please make sure new Backbone Fabric ID does not conflict with any configured
EX-Port's Fabric ID
Backbone fabric ID: (1-128) [128]

switch:admin> fosconfig --enable fcr
FC Router service is enabled

switch:admin> switchenable
```

## FCIP tunnel configuration

The optional Fibre Channel over IP (FCIP) Tunneling Service enables you to use “tunnels” to connect instances of Fibre Channel SANs over IP-based networks to transport all Fibre Channel ISL and IFL traffic. FCIP is a prerequisite for configuring VEX\_Ports; if you are only using FC\_Ports, then there is no need to perform this step.

If using FCIP in your FC-FC Routing configuration, you must first configure FCIP tunnels. Once a tunnel is created, it defaults to a disabled state. Then configure the VE\_Port or VEX\_Port. After the appropriate ports are configured, enable the tunnel.

---

### NOTE

This section is applicable only to Fabric OS fabrics and does not apply to M-EOS fabrics.

---

See the *Fibre Channel over IP Administrator's Guide* for instructions on how to configure FCIP tunnels.

## Inter-fabric link configuration

Before configuring an IFL, be aware that you cannot configure both IFLs (EX\_Ports, VEX\_Ports) and ISLs (E\_Ports) from a backbone fabric to the same edge fabric.

Configuring an inter-fabric link involves disabling ports and cabling them to other fabrics, configuring those ports for their intended use, and then enabling the ports.

To configure an 8-Gbps IFL, both the EX\_Port and the connecting E\_Port must be 8-Gbps ports.

---

### ATTENTION

To ensure that fabrics remain isolated, disable the port prior to inserting the cable. If you are configuring an EX\_Port, disable the port prior to making the connection.

---

### Configuring an IFL for both edge and backbone connections

1. On the FC router, disable the port that you are configuring as an EX\_Port (the one connected to the Fabric OS switch) by issuing the **portDisable** command.

```
switch:admin> portdisable 7/10
```

You can verify that port 7 has been disabled by issuing the **portShow** command for the port.

2. Configure each port that connects to an edge fabric as an EX\_Port or VEX\_Port. Note the following:

- **portCfgVEXPort** works only on VE\_Ports.
- **portCfgEXPort** (only on the FC ports on the FC router) commands work only on ports that are capable of FC-FC routing.

Use the **portCfgEXPort** or **portCfgVEXPort** command to:

- Enable or disable EX\_Port or VEX\_Port mode.
- Set the fabric ID (avoid using fabric IDs 1 and 128, which are the default IDs for backbone connections).

The following example configures the EX\_Port (or VEX\_Port) and assigns a Fabric ID of 30 to port 7.

```
switch:admin> portcfgexport 7/10 -a 1 -f 30
switch:admin> portcfgexport 7/10
Port 7/10 info
Admin: enabled
State: NOT OK
Pid format: Not Applicable
Operate mode: Brocade Native
Edge Fabric ID: 30
Preferred Domain ID: 160
Front WWN: 50:06:06:9e:20:38:6e:1e
Fabric Parameters: Auto Negotiate
R_A_TOV: Not Applicable
E_D_TOV: Not Applicable
Authentication Type: None
DH Group: N/A
Hash Algorithm: N/A
Edge fabric's primary wwn: N/A
Edge fabric's version stamp: N/A
```

This port can now connect to another switch.

For related FC-FC Routing commands, see **forEdgeShow**, **forXlateConfig**, **forConfigure**, and **forProxyConfig** in the *Fabric OS Command Reference*.

A Fibre Channel router can interconnect multiple fabrics. EX\_Ports or VEX\_Ports attached to more than one edge fabric must configure a different fabric ID for each edge fabric.

3. (Optional) Configure FC router port cost, if you want to change the default values. For information about using FC router port cost operations, see [“FC Router port cost configuration”](#) on page 471.
4. (Optional) Set up ISL or EX\_Port trunking. For information on trunking setup, see [“Configuring EX\\_Port frame trunking”](#) on page 476.
5. Enter the **portEnable** command to enable the ports that you disabled in [step 1](#).
 

```
switch:admin> portenable 7/10
```
6. Physically attach ISLs from the Fibre Channel router to the edge fabric.
7. Enter the **portCfgShow** command to view ports that are persistently disabled.

FC ports on the Brocade 7500 and 7800 switches and FR4-18i and FX8-24 blades are configured as persistently disabled by default, to avoid inadvertent fabric merges when installing a new FC router.

```
switch:admin> portcfgshow 7/10
Area Number:          74
Speed Level:          AUTO
Trunk Port             OFF
Long Distance         OFF
VC Link Init          OFF
Locked L_Port         OFF
Locked G_Port         OFF
Disabled E_Port       OFF
ISL R_RDY Mode        OFF
RSCN Suppressed       OFF
Persistent Disable    OFF
NPIV capability       ON
EX Port               ON
Mirror Port           ON
FC Fastwrite          ON
```

8. After identifying such ports, enter the **portCfgPersistentEnable** command to enable the port, and then the **portCfgShow** command to verify the port is enabled.

```
switch:admin> portcfgpersistentenable 7/10
```

```
switch:admin> portcfgshow 7/10
Area Number:          74
Speed Level:          AUTO
Trunk Port             OFF
Long Distance         OFF
VC Link Init          OFF
Locked L_Port         OFF
Locked G_Port         OFF
Disabled E_Port       OFF
ISL R_RDY Mode        OFF
RSCN Suppressed       OFF
Persistent Disable    OFF
NPIV capability       ON
```

## 21 Inter-fabric link configuration

```
EX Port          ON
Mirror Port      ON
FC Fastwrite     ON
```

9. Enter either the **portCfgEXPort** or **portShow** command to verify that each port is configured correctly:

```
switch:admin> portcfgexport 7/10
```

```
Port 7/10 info
Admin:          enabled
State:          NOT OK
Pid format:     Not Applicable
Operate mode:   Brocade Native
Edge Fabric ID: 30
Preferred Domain ID: 160
Front WWN:      50:06:06:9e:20:38:6e:1e
Fabric Parameters: Auto Negotiate
R_A_TOV:        Not Applicable
E_D_TOV:        Not Applicable
Authentication Type: None
DH Group: N/A
Hash Algorithm: N/A
Edge fabric's primary wwn: N/A
Edge fabric's version stamp: N/A
```

```
switch:admin_06> portshow 7/10
```

```
portName:
portHealth: OFFLINE

Authentication: None

EX_Port Mode:  Enabled
Fabric ID:     30
Front Phantom: state = Not OK  Pref Dom ID: 160
Fabric params: R_A_TOV: 0      E_D_TOV: 0      PID fmt: auto

Authentication Type: None
Hash Algorithm: N/A
DH Group: N/A
Edge fabric's primary wwn: N/A
Edge fabric's version stamp: N/A

portDisableReason: None
portCFlags: 0x1
portFlags: 0x1  PRESENT U_PORT EX_PORT
portType: 10.0
portState: 2  Offline
portPhys: 2  No_Module
portScn: 0
port generation number: 0
portId: 014a00
portIfId: 4372080f
portWwn: 20:4a:00:60:69:e2:03:86
portWwn of device(s) connected:

Distance: normal
portSpeed: N4Gbps
```

```

LE domain: 0
FC Fastwrite: ON
Interrupts:      0          Link_failure: 0          Frjt :          0
Unknown:        0          Loss_of_sync: 0          Fbsy :          0
Lli:            0          Loss_of_sig: 2
Proc_rqrd:     0          Protocol_err: 0
Timed_out:     0          Invalid_word: 0
Rx_flushed:    0          Invalid_crc: 0
Tx_unavail:    0          Delim_err:    0
Free_buffer:   0          Address_err:  0
Overrun:       0          Lr_in:        0
Suspended:    0          Lr_out:       0
Parity_err:    0          Ols_in:       0
2_parity_err: 0          Ols_out:      0
CMI_bus_err:  0

```

Port part of other ADs: No

10. Enter the **switchShow** command to verify the EX\_Port (or VEX\_Port), edge fabric ID, and name of the edge fabric switch (containing the E\_Port or VE\_Port) are correct.
11. Enter the **fcFabricShow** command to view any edge fabric's switch names and ensure links are working as expected:

---

#### NOTE

The **fcFabricShow** command displays the static IPv6 addresses for each FC router and each edge fabric switch connected to the EX\_Ports.

---

```

switch:admin> fcrfabricshow
FCR WWN: 10:00:00:05:1e:13:59:00, Dom ID: 2, Info: 10.32.156.52
1080::8:800:200C:1234/64,
"fcr_7500"
EX_Port FID Neighbor Switch Info (WWN, enet IP, name)
-----
7 10 10:00:00:05:1e:34:11:e5 10.32.156.33 "7500" 1080::8:8FF:FE0C:417A/64
4 116 10:00:00:05:1e:37:00:44 10.32.156.34 "7500"
FCR WWN: 10:00:00:05:1e:12:e0:00, Dom ID: 100, Info:10.32.156.50
1080::8:60F:FE0C:456A/64
"fcr_7500"
EX_Port FID Neighbor Switch Info (WWN, enet IP, name)
-----
4 95 10:00:00:05:1e:37:00:45 10.32.156.31 "7500"
FCR WWN: 10:00:00:05:1e:12:e0:00, Dom ID: 100, Info: 10.32.156.50,
"fcr_Brocade 7500"
EX_Port FID Neighbor Switch Info (WWN, enet IP, name)
-----
4 95 10:00:00:05:1e:37:00:45 10.32.156.31 "Brocade 7500"
5 95 10:00:00:05:1e:37:00:45 10.32.156.31 "Brocade 7500"
6 95 10:00:00:05:1e:37:00:45 10.32.156.31 "Brocade 7500"

```

## FC Router port cost configuration

The router port cost is set automatically. This section provides information about the router port cost and describes how you can modify the cost for a port if you want to change the default value.

FC routers optimize the usage of the router port links by directing traffic to the link with the smallest router port cost. The FC router port cost is similar to the link cost setting available on E\_Ports, which allows you to customize traffic flow. The router port link cost values are either 1000 or 10,000. The router module chooses the router port path based on the lowest cost for each FID connection. If multiple paths exist where one path costs lower than the others, then the lowest cost path is used. If exchange-based routing has not been disabled and multiple paths exist with the same lowest cost, there will be load sharing over these paths.

The router port cost feature optimizes the usage of the router port links by directing the traffic to a link with a smaller cost.

Every IFL has a default cost. The default router port cost values are:

- 1000 for legacy (v5.1 or XPath FCR) IFL
- 1000 for EX\_Port IFL
- 10,000 for VEX\_Port IFL

The FCR router port cost settings are 0, 1000, or 10,000. If the cost is set to 0, the default cost will be used for that IFL. The FC router port cost is persistent and is saved in the existing port configuration file.

Router port cost is passed to other routers in the same backbone. Link costs from the front domain to the translate (xlate) domain remain at 10,000. You can use the **IsDbShow** from the edge fabric to display these link costs.

### Port cost considerations

The router port cost has the following considerations:

- Router port sets are defined as follows:
  - 0–7 and FCIP Tunnel 16–23
  - 8–15 and FCIP Tunnel 24–31

More than two router port sets can exist in a Brocade 48000, Brocade DCX, or Brocade DCX-4S with two FR4-18i blades.

- The router port cost does not help distinguish one IFL (or EX\_ and VEX\_Port link) from another, if all the IFLs are connected to the same port set. Therefore, if you connect IFL1 and IFL2 to the same edge fabric in port set 0–7 and then configure them to different router port costs, traffic is still balanced across all the IFLs in the same port set.
- Use proper SAN design guidelines to connect the IFLs to different port sets for effective router port cost use. For example, if both a low-speed IFL and a high-speed IFL are going to the same edge fabric, connect the lower router cost IFLs to a separate port group (for example ports 0–7) than the higher router cost IFLs (for example ports 8–15). For VEX\_Ports, you would use ports in the range of 16–23 or 24–31.

You can connect multiple EX\_Ports or VEX\_Ports to the same edge fabric. The EX\_Ports can all be on the same FC router, or they can be on multiple routers. Multiple EX\_Ports create multiple paths for frame routing. Multiple paths can be used in two different, but compatible, ways:

- Failing over from one path to another.
- Using multiple paths in parallel to increase effective data transmission rates.



EX\_Ports and VEX\_Ports, when connected, are assigned different router port costs and traffic will flow only through the EX\_Ports. Routing failover is automatic, but it can result in frames arriving out of order when frames take different routes. The FC router can force in-order delivery, although frame delivery is delayed immediately after the path failover.

Source EX\_Ports can balance loads across multiple destination EX\_Ports attached to the same edge fabric using exchange IDs from the routed frames as keys to distribute the traffic.

## Setting router port cost for an EX\_Port

The router port cost value for an EX\_Port is set automatically when the EX\_Port is created. However, you can modify the cost for that port. You can configure the EX\_ or VEX\_Port with values of either 1000 or 10,000. If you want to differentiate between two EX\_Port links with different speeds, you can assign 1000 to one link and 10,000 to the other link.

For details about the use of any of the following commands, see the *Fabric OS Command Reference*.

1. Enter the **portDisable** command to disable any port on which you want to set the router port cost.

```
switch:admin> portdisable 7/10
```

2. Enable EX\_Port or VEX\_Port mode with the **portCfgEXPort** or **portCfgVEXPort** command.

```
switch:admin> portcfgexport 7/10 -a 1
```

3. Enter the **forRouterPortCost** command to display the router port cost for each EX\_Port.

```
switch:admin> fcrrouterportcost
Port                Cost
-----
7/3                 1000
7/4                 1000
7/9                 1000
7/10                1000
7/13                1000
10/0                1000
```

You can also use the **forRouteShow** command to display the router port cost.

4. Enter the **forRouterPortCost** command with a port and slot number, to display the router port cost for a single EX\_Port.

```
switch:admin> fcrrouterportcost 7/10
Port                Cost
-----
7/10                1000
```

5. Enter the appropriate form of the **forRouterPortCost** command based on the task you want to perform:

- To set the router port cost for a single EX\_Port, enter the command with a port and slot number and a specific cost:

```
switch:admin> fcrrouterportcost 7/10 10000
```

- To set the cost of the EX\_Port back to the default, enter a cost value of 0:

```
switch:admin> fcrrouterportcost 7/10 0
```

6. Enter the **portEnable** command to enable the ports that you disabled in [step 1](#).

```
switch:admin> portenable 7/10
```

## EX\_Port frame trunking configuration

In Fabric OS v5.2.0 and later, you can configure EX\_Ports to use frame-based trunking just as you do regular E\_Ports. EX\_Port frame trunking support is designed to provide the best utilization and balance of frames transmitted on each link between the FC router and the edge fabric. You should trunk all ports connected to the same edge fabrics.

The FC router front domain has a higher node WWN—derived from the FC router—than that of the edge fabric. Therefore, the FC router front domain initiates the trunking protocol on the EX\_Port.

After initiation, the first port from the trunk group that comes online is designated as the master port. The other ports that come online on the trunk group are considered the slave ports. Adding or removing a slave port does not cause frame drop; however, removing a slave port causes the loss of frames in transit.

The restrictions for EX\_Port frame trunking are the same as for E\_Ports—all the ports must be adjacent to each other using the clearly marked groups on the front of the product.

---

### ATTENTION

This feature should be enabled only if the entire configuration is running Fabric OS v5.2.0 or later.

---

If router port cost is used with EX\_Port trunking, the master port and slave ports share the router port cost of the master port.

For information about setting up E\_Port trunking on an edge fabric, see [Chapter 19, “Managing Trunking Connections,”](#) in this guide.

## Masterless EX\_Port trunking

Starting in Fabric OS 6.3.0, EX\_Port frame-based trunking is masterless. This means that if the master port goes offline, one of the slave ports automatically becomes the new master port and all of the other slave ports stay online, thus avoiding traffic disruption. The new master port uses the old master port area and the old master port is assigned a new, unused area. In this way, the PID of the trunk does not change if the master port goes offline.

Masterless EX\_Port trunking is supported only on EX\_Ports in the following platforms:

- Brocade DCX and DCX-4S (FC8-16, FC8-32, FC8-48, FC8-64, FS8-18, or FX8-24)
- Brocade 5100 switch
- Brocade 5300 switch
- Brocade VA-40FC switch
- Brocade Encryption Switch

For the Brocade DCX and DCX-4S, Virtual Fabrics must be enabled for masterless EX\_Port trunking to take effect. For the Brocade 5100, 5300, VA-40FC, and Brocade Encryption Switch, Virtual Fabrics can be enabled or disabled.

For EX\_Ports on the Brocade 7500 or the FR4-18i blade, or for EX\_Ports on the Brocade DCX or DCX-4S with Virtual Fabrics mode disabled, masterless EX\_Port trunking is not in effect. In this situation, if the master port goes offline, the entire EX\_Port-based trunk re-forms and is taken offline for a short period of time. If there are no other links to the edge fabric from the backbone, the master port going offline may cause a traffic disruption in the backbone.

[Table 94](#) lists the platforms that support FC-FC routing, indicates whether masterless EX\_Port frame trunking is supported and, if supported, whether Virtual Fabrics must be enabled or disabled.

**TABLE 94 Supported platforms and VF mode for masterless EX\_Port trunking**

Supported platforms for FCR	Masterless EX_Port trunking supported?	VF mode required for masterless EX_Port trunking
Brocade DCX and DCX-4S:		
FC8-16	yes	enabled
FC8-32	yes	enabled
FC8-48	yes	enabled
FC8-64	yes	enabled
FS8-18	yes	enabled
FX8-24	yes	enabled
FR4-18i	no	n/a
Brocade 5100	yes	enabled or disabled
Brocade 5300	yes	enabled or disabled
Brocade VA-40FC	yes	enabled or disabled
Brocade Encryption Switch	yes	enabled or disabled
Brocade 7500	no	n/a
Brocade 7800	no	n/a
Brocade 48000:		
FR4-18i	no	n/a

## Supported configurations and platforms

The EX\_Port trunking is an FCR software feature and requires that you have a trunking license installed on the FC router and on the edge fabric connected to the other side of the trunked EX\_Ports. EX\_Port trunking is supported only with Brocade edge fabrics. You can use EX\_Port frame trunking in the following configurations and cases:

- For ports with speeds of 2 Gbps up to a maximum speed of 8 Gbps and trunking over long distance.
- In the edge fabric, when the FC router is connected to a switch that supports eight ports from the trunkable group.
- When the FC router is connected to an edge fabric using a mix of trunked and non-trunked EX\_Ports. All will share the same front domain.
- In edge-to-edge, backbone-to-edge, and dual backbone configurations.

Masterless EX\_Port trunking has additional configuration requirements. See [“Masterless EX\\_Port trunking”](#) on page 474 for these additional requirements.

### NOTE

QoS and EX\_Port trunking can co-exist; however, if some ports in the trunk group have QoS enabled and some have QoS disabled, then two trunk groups will form: one with QoS enabled and one with QoS disabled.

### *High availability support*

The EX\_Port frame trunking feature also is a High Availability (HA) supported feature. The HA protocol for EX\_Port trunking is as follows:

- If trunking is disabled prior to the HA failover, it remains disabled after the HA failover.
- If trunking is enabled prior to the HA failover, it remains enabled after the HA failover.

### *Backward compatibility support*

For backward compatibility, an FC router that supports EX\_Port trunking can continue to interoperate with older FC routers and all previously supported Brocade switches in the backbone fabric or Brocade edge fabric.

## Configuring EX\_Port frame trunking

With EX\_Port frame trunking, you can use the same CLI commands as you do for E\_Port trunking.

Administration control for EX\_Port trunking is available through root, admin, and switch admin access.

The procedures for administering EX\_Port frame trunking are the same as for E\_Port trunking. You initialize trunking on ports with **portCfgTrunkPort** or **switchCfgTrunk**, and monitor traffic with the **portPerfShow** command.

For details about using these commands, see [Chapter 19, “Managing Trunking Connections,”](#) and individual commands in the *Fabric OS Command Reference*.

## Displaying EX\_Port trunking information

1. Log in as an admin and connect to the switch.
2. Enter the **switchShow** command to display trunking information for the EX\_Ports.

```
fcr_switch:admin_06> switchshow
```

### Example

The following is an example of a master EX\_Port and a slave EX\_Port displayed in **switchShow**.

```
Index Slot Port Address Media Speed State
=====
16 2 0 ee1000 id N4 No_Light
17 2 1 ee1100 id N4 Online EX_Port (Trunk port, master is Slot 2 Port 2 )
18 2 2 ee1200 id N4 Online EX_Port 10:00:00:05:1e:35:bb:32 "MtOlympus_82"
(fabric id = 2 ) (Trunk master)
19 2 3 ee1300 id N4 No_Light
20 2 4 ee1400 id N4 Online EX_Port (Trunk port, master is Slot 2 Port 7 )
21 2 5 ee1500 id N4 Online EX_Port (Trunk port, master is Slot 2 Port 7 )
22 2 6 ee1600 id N4 Online EX_Port (Trunk port, master is Slot 2 Port 7 )
23 2 7 ee1700 id N4 Online EX_Port 10:00:00:60:69:80:1d:bc "MtOlympus_72"
(fabric id = 2 ) (Trunk master)
```

## LSAN zone configuration

An LSAN consists of zones in two or more edge or backbone fabrics that contain the same devices. LSANs essentially provide selective device connectivity between fabrics without forcing you to merge those fabrics. FC routers provide multiple mechanisms to manage inter-fabric device connectivity through extensions to existing switch management interfaces. You can define and manage LSANs using Brocade Advanced Zoning.

### Use of Admin Domains with LSAN zones and FCR

You can create LSAN zones as a physical fabric administrator or as an individual Admin Domain (AD) administrator. The LSAN zone can be part of the root zone database or the AD zone database. FCR harvests the LSAN zones from all administrative domains. If both edge fabrics have the matching LSAN zones and both devices are online, FCR triggers a device import. To support legacy applications, WWNs are reported based on the administrative domain context. As a result, you must not use the network address authority (NAA) field in the WWN to detect an FC router. LSAN zone enforcement in the local fabric occurs only if the administration domain member list contains both of the devices (local and imported device) specified in the LSAN zone.

For more information, see [Chapter 15, “Managing Administrative Domains”](#).

### Zone definition and naming

Zones are defined locally on a switch or director. Names and memberships, with the exception of hosts and targets exported from one fabric to another, do not need to be coordinated with other fabrics. For example, in [Figure 70](#) on page 460, when the zones for Edge SAN 1 are defined, you do not need to consider the zones in Edge SAN 2, and vice versa.

Zones that contain hosts and targets that are shared between the two fabrics need to be explicitly coordinated. To share devices between any two fabrics, you must create an LSAN zone in both fabrics containing the port WWNs of the devices to be shared. Although an LSAN is managed using the same tools as any other zone on the edge fabric, two behaviors distinguish an LSAN from a conventional zone:

- A required naming convention. The name of an LSAN begins with the prefix “LSAN\_”. The LSAN name is case-insensitive; for example, *lsan\_* is equivalent to *LSAN\_*, *Lsan\_*, and so on.
- Members must be identified by their port WWN because port IDs are not necessarily unique across fabrics. The names of the zones need not be explicitly the same, and membership lists of the zones need not be in the same order.

---

#### NOTE

The “LSAN\_” prefix must appear at the beginning of the zone name. LSAN zones may not be combined with QoS zones. See [“QoS zones”](#) on page 406 for more information about the naming convention for QoS zones.

---

To enable device sharing across multiple fabrics, you must create LSAN zones on the edge fabrics (and optionally on the backbone fabric, as well), using normal zoning operations to create zones with names that begin with the special prefix “LSAN\_”, and adding host and target port WWNs from both local and remote fabrics to each local zone as desired. Zones on the backbone and on multiple edge fabrics that share a common set of devices will be recognized as constituting a single multi-fabric LSAN zone, and the devices that they have in common will be able to communicate with each other across fabric boundaries.

## LSAN zones and fabric-to-fabric communications

Zoning is enforced by all involved fabrics; any communication from one fabric to another must be allowed by the zoning setup on both fabrics. If the SANs are under separate administrative control, then separate administrators maintain access control.

## Controlling device communication with the LSAN

The following procedure illustrates how LSANs control which devices can communicate with each other. The procedure shows the creation of two LSANs (called *lsan\_zone\_fabric75* and *lsan\_zone\_fabric2*), which involve the following devices and connections:

- Switch1 and the host in fabric75.
  - Switch2, Target A, and Target B in fabric2.
  - Switch1 is connected to the FC router using an EX\_Port or VEX\_Port.
  - Switch2 is connected to the FC router using another EX\_Port or VEX\_Port.
  - Host has WWN 10:00:00:00:c9:2b:c9:0c (connected to switch1).
  - Target A has WWN 50:05:07:61:00:5b:62:ed (connected to switch2).
  - Target B has WWN 50:05:07:61:00:49:20:b4 (connected to switch2).
1. Log in as admin and connect to switch1.
  2. Enter the **nsShow** command to list the WWN of the host (10:00:00:00:c9:2b:c9:0c).

---

### NOTE

The **nsShow** output displays both the port WWN and node WWN; the port WWN must be used for LSANs.

---

```
switch:admin> nsshow
{
  Type Pid      COS      PortName      NodeName
  TTL(sec)
  N   060f00;   2,3;    10:00:00:00:c9:2b:c9:0c;  20:00:00:00:c9:2b:c9:0c; na
  FC4s: FCP
  NodeSymb: [35] "Emulex LP9002 FV3.91A3 DV5-5.20A6 "
  Fabric Port Name: 20:0f:00:05:1e:37:00:44
  Permanent Port Name: 10:00:00:00:c9:2b:c9:0c
  The Local Name Server has 1 entry }
```

3. Enter the **zoneCreate** command to create the LSAN *lsan\_zone\_fabric75*, which includes the host.

```
switch:admin> zonecreate "lsan_zone_fabric75", "10:00:00:00:c9:2b:c9:0c"
```

4. Enter the **zoneAdd** command to add Target A to the LSAN.

```
FID75Domain5:admin> zoneadd "lsan_zone_fabric75", "50:05:07:61:00:5b:62:ed"
```

5. Enter the **cfgAdd** or **cfgCreate** and **cfgEnable** commands to add and enable the LSAN configuration.

```
switch:admin> cfgadd "zone_cfg", "lsan_zone_fabric75"
switch:admin> cfgenable "zone_cfg"
You are about to enable a new zoning configuration.
This action will replace the old zoning configuration with the
current configuration selected.
```

```
Do you want to enable 'zone_cfg' configuration (yes, y, no, n): [no] y
zone config "zone_cfg" is in effect
Updating flash ...
```

6. Log in as admin to fabric2.

7. Enter the **nsShow** command to list Target A (50:05:07:61:00:5b:62:ed) and Target B (50:05:07:61:00:49:20:b4).

```
switch:admin> nsshow
{
  Type Pid    COS      PortName                               NodeName                               TTL(sec)
  NL  0508e8; 3;    50:05:07:61:00:5b:62:ed; 50:05:07:61:00:1b:62:ed; na
      FC4s: FCP [IBM    DNEF-309170    F90F]
      Fabric Port Name: 20:08:00:05:1e:34:11:e5
      Permanent Port Name: 50:05:07:61:00:5b:62:ed
  NL  0508ef; 3;    50:05:07:61:00:49:20:b4; 50:05:07:61:00:09:20:b4; na
      FC4s: FCP [IBM    DNEF-309170    F90F]
      Fabric Port Name: 20:08:00:05:1e:34:11:e5
      Permanent Port Name: 50:05:07:61:00:49:20:b4
  The Local Name Server has 2 entries }
```

8. Enter the **zoneCreate** command to create the LSAN *lsan\_zone\_fabric2*, which includes the host (10:00:00:00:c9:2b:6a:2c), Target A, and Target B.

```
switch:admin> zonecreate "lsan_zone_fabric2",
"10:00:00:00:c9:2b:c9:0c;50:05:07:61:00:5b:62:ed;50:05:07:61:00:49:20:b4"
```

9. Enter the **cfgShow** command to verify that the zones are correct.

```
switch:admin> cfgshow
Defined configuration:
  zone:  lsan_zone_fabric2
          10:00:00:00:c9:2b:c9:0c; 50:05:07:61:00:5b:62:ed;
          50:05:07:61:00:49:20:b4

Effective configuration:
  no configuration in effect
```

10. Enter the **cfgAdd** and **cfgEnable** commands to create and enable the LSAN configuration.

```
switch:admin> cfgadd "zone_cfg", "lsan_zone_fabric2"
switch:admin> cfgenable "zone_cfg"
You are about to enable a new zoning configuration.
This action will replace the old zoning configuration with the
current configuration selected.
Do you want to enable 'zone_cfg' configuration (yes, y, no, n): [no] y
zone config "zone_cfg" is in effect
Updating flash ...
```

11. Log in as an admin and connect to the FC router.

12. Enter the following commands to display information about the LSANs.

- **lsanZoneShow -s** shows the LSAN.

```
switch:admin> lsanzoneshow -s
Fabric ID: 2 Zone Name: lsan_zone_fabric2
          10:00:00:00:c9:2b:c9:0c Imported
          50:05:07:61:00:5b:62:ed EXIST
          50:05:07:61:00:49:20:b4 EXIST
Fabric ID: 75 Zone Name: lsan_zone_fabric75
          10:00:00:00:c9:2b:c9:0c EXIST
          50:05:07:61:00:5b:62:ed Imported
```

- **fcrPhyDevShow** shows the physical devices in the LSAN.

```
switch:admin> fcrphydevshow
      Device          WWN          Physical
      Exists
      in Fabric
-----
      75 10:00:00:00:c9:2b:c9:0c c70000
      2  50:05:07:61:00:5b:62:ed 0100ef
      2  50:05:07:61:00:5b:62:ed 0100e8
Total devices displayed: 3
```

- **fcrProxyDevShow** shows the proxy devices in the LSAN.

```
switch:admin> fcrproxydevshow
      Proxy          WWN          Proxy          Device          Physical          State
      Created
      in Fabric
      PID          Exists
      in Fabric
-----
      75  50:05:07:61:00:5b:62:ed 01f001          2          0100e8          Imported
      2  10:00:00:00:c9:2b:c9:0c 02f000          75          c70000          Imported
Total devices displayed: 2
```

On the FC router, the host and Target A are imported, because both are defined by *lsan\_zone\_fabric2* and *lsan\_zone\_fabric75*. However, target B is defined by *lsan\_zone\_fabric75* and is not imported because *lsan\_zone\_fabric2* does not allow it.

When a PLOGI, PDISC, or ADISC arrives at the FC router, the SID and DID of the frame are checked. If they are LSAN-zoned at both SID and DID edge fabrics, the frame is forwarded to the DID. If they are not zoned, only the PLOGI is dropped; for the remaining frames zoning enforcement takes place in the edge fabrics.

## Setting the maximum LSAN count

You can set the maximum number of LSAN zones, or LSAN count, that can be configured on the edge fabrics. By default, the maximum LSAN count is set to 3000. You can increase the maximum LSAN count to 5000 without disabling the switch.

The maximum number of LSAN devices supported is 10000 (this includes both physical and proxy devices). If you have 3000 LSAN zones but have not exceeded the 10000 device limit, you can increase the LSAN count to 5000.

All FC routers in the same backbone fabric should have the same maximum LSAN count defined, to prevent the FC routers from running into indefinite state. Asymmetric LSAN configurations due to different maximum LSAN counts could lead to different devices being imported on different FC routers.

1. Enter the **fcrlsancount** command with no parameters to display the current LSAN limit.

```
switch:admin> fcrlsancount
LSAN Zone Limit 3000
```

2. Enter the **fcrlsancount** command and specify the new LSAN zone limit.

```
switch:admin> fcrlsancount 5000
LSAN Zone Limit 5000
```

For information on how to display the maximum allowed and currently used LSAN zones and devices, see [“Resource monitoring”](#) on page 491.



---

**NOTE**

Since the maximum number of LSANs is configured for each switch, if there is a different maximum LSAN count on the switches throughout the metaSAN, then the device import/export will not be identical on the FC routers. You should enter the same maximum LSAN count for all the FC routers in the same backbone that support this feature. Verify the configured maximum limit against the LSANs configured using the `fcrResourceShow` command.

---

## Configuring backbone fabrics for interconnectivity

If you want devices in backbone fabrics to communicate with devices in edge fabrics, follow the steps in the section “[Setting up LSAN zone binding](#)” on page 488. However, instead of configuring the LSAN in the second edge fabric, configure the LSAN in the backbone fabric.

## HA and downgrade considerations for LSAN zones

Be aware of how LSAN zones impact high availability and firmware downgrades:

- The LSAN zone matrix is synchronized to the standby CP.
- On a dual CP switch, both CPs must have Fabric OS v5.3.0 or later to enable the feature.
- If the feature is enabled on the active CP, introducing a CP with an earlier version of Fabric OS as a standby will cause HA synchronization to fail.
- If the feature is enabled, before downgrading to an earlier Fabric OS version, you will be asked to go back to the default mode.
- This feature does not have any impact on current HA functionality. LSANs will be synchronized as usual after the limit is increased and new LSANs are created.

## LSAN zone policies using LSAN tagging

You can create tags for LSAN zones to give them a special meaning.

LSAN zones are zones with names that start with the “lsan\_” prefix. You can specify a tag to append to this prefix that causes the LSAN zone to be treated differently.

You can specify two types of tags:

- Enforce tag – Specifies which LSANs are to be enforced in an FC router.
- Speed tag – Specifies which LSANs are to be imported or exported faster than other LSANs.

The LSAN tags are persistently saved and support `configupload` and `configdownload`.

### *Enforce tag*

The Enforce tag reduces the resources used in an FC router by limiting the number of LSAN zones that will be enforced in that FC router.

Use the Enforce tag to achieve better scalability in the FC router. This is useful when multiple FC routers are connected to the same edge fabric. Without the Enforce tag, all FC routers import all LSAN zones, even those that are not needed.

Normally the FC router automatically accepts all zones with names that start with “lsan\_”. You can specify an Enforce tag to indicate that a particular FC router should only accept zones that start with the prefix “lsan\_tag”. For example, if you specify an Enforce tag of “abc”, the FC router accepts only those LSAN zones that start with “lsan\_abc” and does not import or export any other LSAN zones.

The Enforce tag can be up to 8 characters long and can contain only letters and numbers. The Enforce tag is case-insensitive; for example, the tag “abc” is equivalent to “ABC” and “Abc”.

If you specify “abc”, “xyz”, and “fab1” as Enforce tags, then the FC router accepts only those LSAN zones with names that start with any of the following:

```
lsan_abc
lsan_xyz
lsan_fab1
```

In this example, the following LSAN zones would all be accepted:

```
lsan_abc
lsan_xyz123456
LSAN_FAB1_abc
```

You can specify up to eight Enforce tags on an FC router.

### ***Speed tag***

During target discovery, the FC router process of presenting proxy devices and setting up paths to the proxy devices might cause some sensitive hosts to time out or fail. The Speed tag allows you to speed up the discovery process by importing the devices into the remote edge fabrics when the devices come online, regardless of the state of the host. This helps sensitive hosts to quickly discover the devices without timing out.

You set the Speed tag on the FC router, and then configure the LSANs in the target edge fabrics with the tag.

For example, in [Figure 74](#) on page 483 assume that the host, H1, needs fast access to target devices D1 and D2. You could set up the Speed tag as follows:

1. In FC router 1 and FC router 2, configure the Speed tag as “super”.
2. In edge fabric 2, configure two LSANs:

```
lsan_f2_f1 (H1, D1)
lsan_f2_f3 (H1, D2)
```

The LSAN in the host fabric does not need the tag.

3. In edge fabric 1, configure the following LSAN:

```
lsan_super_f1_f2 (H1, D1)
```

4. In edge fabric 3, configure the following LSAN:

```
lsan_super_f3_f2 (H1, D2)
```

5. Toggle either the host or target to trigger the fast import process.

The “super” tag is needed only in the LSANs of the target fabrics.

The target proxies D1 and D2 are always present in the host fabric (edge fabric 2), even if the host is brought down. A target proxy is removed from the host fabric when the target device is offline.

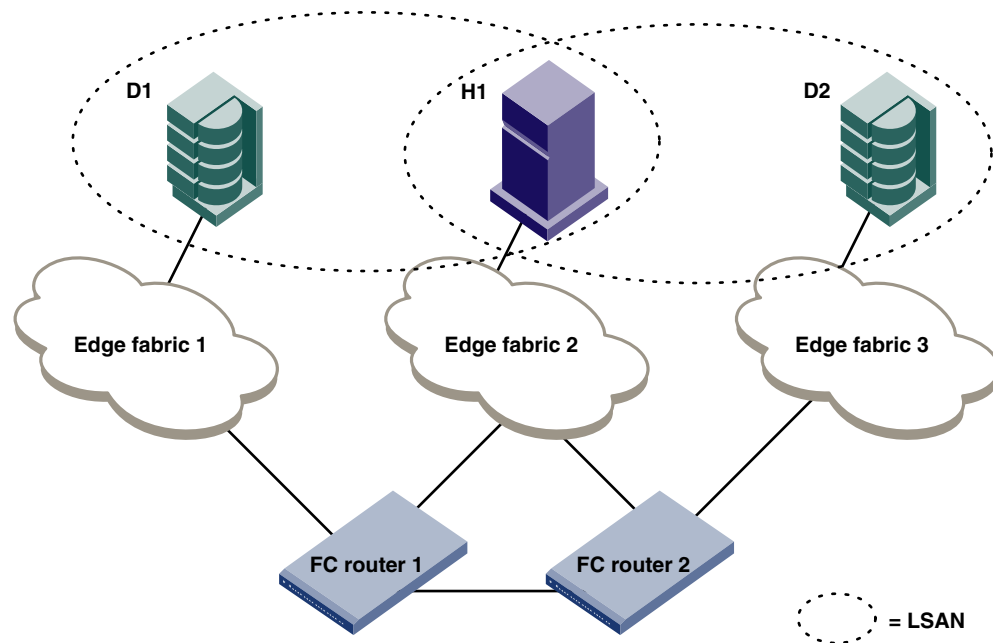

FIGURE 74 Example of setting up Speed LSAN tag

### *Rules for LSAN tagging*

Note the following rules for configuring LSAN tags:

- You configure the tags on the FC router, and not on the edge switches. If Virtual Fabrics are enabled, you configure the tags on the base switch on which the EX\_ and VEX\_Ports are located. You then have to ensure that the LSAN zones in the edge fabrics incorporate the tags correctly.
- The LSAN tags are configured per FC router, not per fabric. If the backbone fabric has multiple FC routers, it is recommended that you configure the LSAN tags on all of the FC routers.
- The FC router must be disabled before you configure the Enforce tag. Configuring the Speed tag does not require that the FC router be disabled; however, after configuring the Speed tag, you must toggle the host or target port to trigger the fast import process.
- The tag is from 1 to 8 alphanumeric characters.
- You can configure only one Speed tag on an FC router, and up to 8 Enforce tags on an FC router. The maximum number of tags (Enforce and Speed) on an FC router is 8.
- Up to 500 Speed LSANs are supported.

### *Configuring an Enforce LSAN tag*

1. Log in to the FC router as admin.
2. Enter the following command to disable the FC router:

```
switchdisable
```

3. Enter the following command to create an Enforce LSAN tag:

```
fcrlsan --add -enforce tagname
```

where *tagname* is the name of the LSAN tag you want to create.

4. Enter the following command to enable the FC router:

```
switchenable
```

5. Change the names of the LSAN zones in the edge fabrics to incorporate the tag in the names.

### Example

```
sw0:admin> switchdisable  
sw0:admin> fcrlsan --add -enforce enftag1  
LSAN tag set successfully  
sw0:admin> switchenable
```

### *Configuring a Speed LSAN tag*

1. Log in to the FC router as admin.
2. Enter the following command to create a Speed LSAN tag:

```
fcrlsan --add -speed tagname
```

where *tagname* is the name of the LSAN tag you want to create.

3. Change the names of the LSAN zones in the edge fabrics to incorporate the tag in the names.
4. Toggle the host or target port to trigger the fast import process.

### Example

```
sw0:admin> fcrlsan --add -speed fasttag2  
LSAN tag set successfully
```

### *Removing an LSAN tag*

Use the following procedure to remove an LSAN tag. This procedure does not remove the LSAN zone; it just deactivates the tag so that LSAN zones with this tag in the name now behave as regular LSAN zones.

You must disable the switch before removing an Enforce LSAN tag. You do not need to disable the switch to remove a Speed LSAN tag.

1. Log in to the FC router as admin.
2. Enter the **fcrlsan --remove** command to remove an existing LSAN tag.

If you remove an Enforce LSAN tag, you must disable the switch first.

### Example of removing an Enforce LSAN tag

```
sw0:admin> switchdisable  
sw0:admin> fcrlsan --remove -enforce enftag1  
LSAN tag removed successfully  
sw0:admin> switchenable
```

### Example of removing a Speed LSAN tag

```
sw0:admin> fcrlsan --remove -speed fasttag2  
LSAN tag removed successfully
```

### *Displaying the LSAN tag configuration*

1. Log in to the FC router as admin.
2. Enter the **fcrlsan --show** command.

**Example**

```
sw0:admin> fcrlsan --show -enforce

Total LSAN tags : 1
  ENFORCE : enftag1
sw0:admin> fcrlsan --show -speed

Total SPEED tags : 1
  SPEED : fasttag2
sw0:admin> fcrlsan --show -all

Total LSAN tags : 2
  ENFORCE : enftag1
  SPEED   : fasttag2
```

## LSAN zone binding

LSAN zone binding is an optional, advanced feature that increases the scalability envelope for very large metaSANs.

---

**NOTE**

LSAN zone binding is supported only on FC routers with Fabric OS v5.3.0 and later. The FC router matrix feature is supported only on FC routers with Fabric OS v6.1.0 and later.

---

Without LSAN zone binding, every FC router in the backbone fabric maintains the entire LSAN zone and device state database. The size of this database limits the number of FC routers and devices you can have.

With LSAN zone binding, each FC router in the backbone fabric stores only the LSAN zone entries of the remote edge fabrics that can access its local edge fabrics. The LSAN zone limit supported in the backbone fabric is not limited by the capability of one FC router. In addition, due to the lower LSAN count, the CPU consumption by the FC router is lower. If you configure the metaSAN such that the backbone fabric has two groups of FC routers and there is no LSAN zone sharing and device access between the two groups, the number of FC routers and devices supported in the backbone fabric can be higher.

[Figure 75](#) on page 486 shows a sample metaSAN with four FC routers in the backbone fabric. Without LSAN zone binding, each FC router in the backbone fabric would store information about LSAN zones 1, 2, 3, and 4.

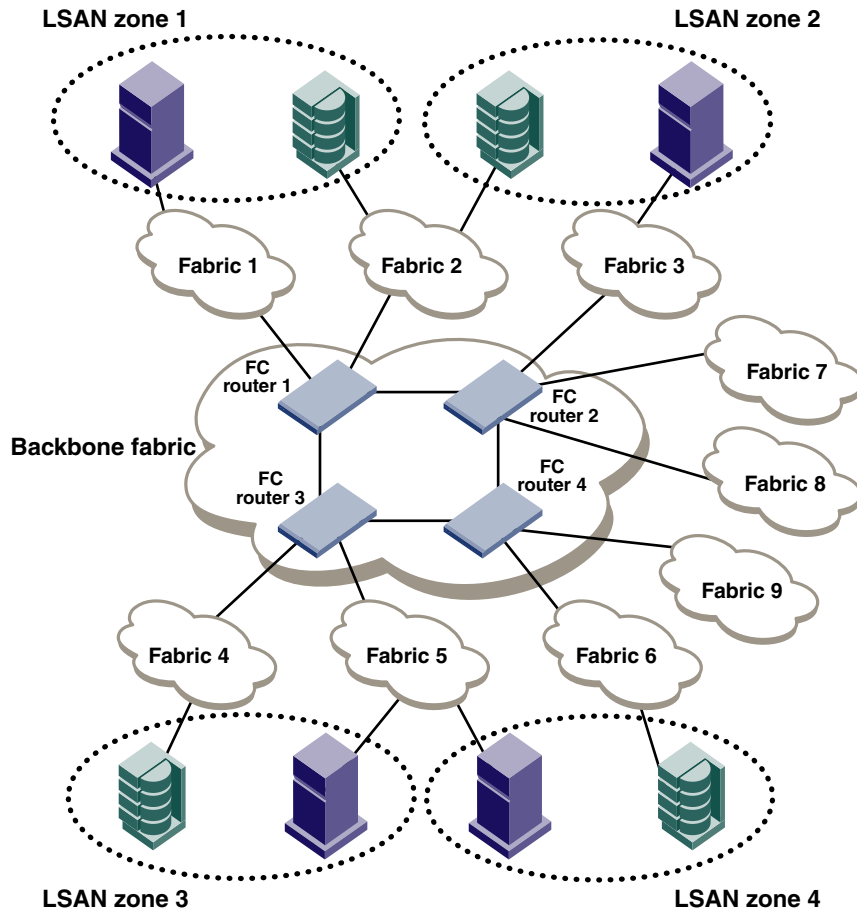

FIGURE 75 LSAN zone binding

After you set up LSAN zone binding, each FC router stores information about only those LSAN zones that access its local edge fabrics. Table 95 shows what LSAN information is stored in each FC router before and after LSAN zone binding is in effect.

TABLE 95 LSAN information stored in each FC router with and without LSAN zone binding

Without LSAN zone binding				With LSAN zone binding			
FC router 1	FC router 2	FC router 3	FC router 4	FC router 1	FC router 2	FC router 3	FC router 4
LSAN 1	LSAN 1	LSAN 1	LSAN 1	LSAN 1	LSAN 2	LSAN 3	LSAN 4
LSAN 2	LSAN 2	LSAN 2	LSAN 2	LSAN 2		LSAN 4	
LSAN 3	LSAN 3	LSAN 3	LSAN 3				
LSAN 4	LSAN 4	LSAN 4	LSAN 4				

To summarize:

- Without LSAN zone binding, the maximum number of LSAN devices is 10,000.
- With LSAN zone binding, the metaSAN can import more than 10,000 devices and the backbone fabric can support more FC routers.
- With LSAN zone binding, CPU consumption by an FC router is lower.

## *How LSAN zone binding works*

LSAN zone binding uses an *FC router matrix*, which specifies pairs of FC routers in the backbone fabric that can access each other, and an *LSAN fabric matrix*, which specifies pairs of edge fabrics that can access each other.

You set up LSAN zone binding using the **fcrLsanMatrix** command. This command has two options: **-fcr** and **-lsan**. The **-fcr** option is for creating and updating the FC router matrix, and the **-lsan** option is used for creating and updating the LSAN fabric matrix.

---

### NOTE

**Best practice:** Use this feature in a backbone fabric in which all FC routers are running Fabric OS v6.1.0 or later.

---

When you set up LSAN zone binding on the local FC router (running Fabric OS v6.1.0 or later), the resultant matrix database is automatically distributed to all of the v6.1.0 or later FC routers in the backbone fabric. You do not need to set up LSAN zone binding on the other FC routers unless those FC routers are running Fabric OS versions earlier than v6.1.0.

If a new FC router joins the backbone fabric, the matrix database is automatically distributed to that FC router.

Note the following for FC routers running a Fabric OS version earlier than 6.1.0:

- The matrix database is not automatically distributed from this FC router to other FC routers.
- You must manually configure the LSAN fabric matrix on these FC routers to match the other FC routers in the backbone fabric.

If you have a dual backbone configuration, where two backbone fabrics share edge fabrics, the LSAN fabric matrix and FC router matrix settings for the shared edge fabrics must be the same on both backbone fabrics. The matrix databases are *not* automatically propagated from one backbone fabric to another, so you must ensure that both backbone fabrics have the same matrix settings.

---

### NOTE

You can use LSAN zone binding along with the LSAN tagging to achieve better scalability and performance. See [“LSAN zone policies using LSAN tagging”](#) on page 481 for information about using the Enforce LSAN tag.

---

## *FC router matrix definition*

Depending on the structure of the backbone fabric, you can specify pairs of FC routers that can access each other. For the metaSAN shown in [Figure 75](#), the following FC routers can access each other:

- FC router 1 and FC router 2
- FC router 3 and FC router 4

Because there is no device sharing between the two groups of FC routers, you can use the **fcrLsanMatrix** command with the **-fcr** option to create the corresponding FC router matrix:

```
fcrLsanmatrix --add -fcr wwn1 wwn2
fcrLsanmatrix --add -fcr wwn3 wwn4
```

where *wwn1*, *wwn2*, *wwn3*, and *wwn4* are the WWNs of the four FC routers.

Now edge fabrics 1, 2, 3, 7, and 8 can access each other, and edge fabrics 4, 5, 6, and 9 can access each other; however, edge fabrics in one group cannot access edge fabrics in the other group.

### *LSAN fabric matrix definition*

With LSAN zone binding, you can specify pairs of fabrics that can access each other. Using the metaSAN shown in [Figure 75](#) as an example, the following edge fabrics can access each other:

- Fabric 1 and Fabric 2
- Fabric 2 and Fabric 3
- Fabric 4 and Fabric 5
- Fabric 5 and Fabric 6

You can use the **fcrLsanMatrix** command with the **-lsan** option to create the corresponding LSAN fabric matrix:

```
fcrlsanmatrix --add -lsan 1 2
fcrlsanmatrix --add -lsan 2 3
fcrlsanmatrix --add -lsan 4 5
fcrlsanmatrix --add -lsan 5 6
```

Fabrics that are not specified are part of the default binding and can access other edge fabrics that are not specified. So Fabrics 7, 8, and 9 can access each other, but cannot access Fabrics 1 through 6.

---

#### ATTENTION

The command **fcrLsanMatrix --add -lsan 0 0** will erase the entire LSAN fabric matrix settings in the cache.

---

The FC router matrix and the LSAN fabric matrix are used together to determine which fabrics can access each other, with the LSAN fabric matrix providing more specific binding.

### *Setting up LSAN zone binding*

1. Log in to the FC router as admin.
2. Enter the following command to add a pair of FC routers that can access each other:

```
FCR:Admin> fcrlsanmatrix --add -fcr wwn1 wwn2
```

where *wwn1* and *wwn2* are the WWNs of the FC routers.

3. Enter the following command to add a pair of edge fabrics that can access each other:

```
FCR:Admin> fcrlsanmatrix --add -lsan fid1 fid2
```

where *fid1* and *fid2* are the fabric IDs of the edge fabrics.

4. Enter the following command to apply the changes persistently:

```
FCR:Admin> fcrlsanmatrix --apply -all
```

#### Example

```
FCR:Admin> fcrlsanmatrix --add -fcr 10:00:00:60:69:c3:12:b2
10:00:00:60:69:c3:12:b3
FCR:Admin> fcrlsanmatrix --add -lsan 4 5
FCR:Admin> fcrlsanmatrix --add -lsan 4 7
FCR:Admin> fcrlsanmatrix --add -lsan 10 19
FCR:Admin> fcrlsanmatrix --apply -all
```



### Viewing the LSAN zone binding matrixes

1. Log on to the FC router as admin.
2. Enter the following command to view the FC router matrix:

```
fcrlsanmatrix --fabricview -fcr
```

3. Enter the following command to view the LSAN fabric matrix:

```
fcrlsanmatrix --fabricview -lsan
```

#### Example

```
FCR:Admin> fcrlsanmatrix --fabricview -fcr

SAVED FCR PAIRS
=====
FCR                                FCR
-----
10:00:00:60:69:c3:12:b2 (2)      10:00:00:60:69:c3:12:b3 (unknown)

FCR:Admin> fcrlsanmatrix --fabricview -lsan
LSAN MATRIX is activated

Fabric ID      Fabric ID
-----
      4          5
      4          7
     10         19
```

## Proxy PID configuration

When an FC router is first configured, the PIDs for the proxy devices are automatically assigned. Proxy PIDs (as well as phantom domain IDs) persist across reboots.

The most common situation in which you would set a proxy PID is when you replace a switch. If you replace the switch and want to continue using the old PID assignments, you can configure it to do so; this value remains in the system even if the blade is replaced. To minimize disruption to the edge fabrics, set the proxy PIDs to the same values used with the old hardware.

The **fcrProxyConfig** command displays or sets the persistent configuration of proxy devices. Used with the **-s slot** option, it can also influence the assignment of the xlate domain port number (which is used to determine the Area\_ID field of the PID) and the Port\_ID field. Like the PIDs in a fabric, a proxy PID must be unique. If the *slot* argument results in a duplicate PID, it will be ignored. Proxy PIDs are automatically assigned to devices imported into a fabric, starting at f001. For Proxy IDs projected to an M-EOS edge fabric in McDATA fabric mode, use valid ALPAs (lower 8 bits).

Use the **fcrXlateConfig** command to display or assign a preferred domain ID to a translate domain.

## Fabric parameter considerations

By default, EX\_Ports and VEX\_Ports detect, autonegotiate, and configure the fabric parameters without user intervention.

You can optionally configure these parameters manually.

- To change the fabric parameters on a switch in the edge fabric, use the **configure** command. Note that to access all of the fabric parameters controlled by this command, you must disable the switch using the **switchDisable** command. If executed on an enabled switch, only a subset of attributes are configurable.
- To change the fabric parameters of an EX\_Port on the FC router, use the **portCfgEXPort** command.
- To change the fabric parameters of a VEX\_Port, then use the **portCfgVEXPort** command.

The backbone fabric PID mode and the edge fabric PID mode do not need to match, but the PID mode for the EX\_Port or VEX\_Port and the edge fabric to which it is attached must match. You can statically set the PID mode for the fabric by using the **-p** option with the **portCfgEXPort** command. Use the **-t** option to disable the negotiate fabric parameter feature; otherwise, the PID mode is autonegotiated. The various edge fabrics may have different PID modes.

Fabric parameter settings, namely, E\_D\_TOV (error-detect timeout value), R\_A\_TOV (resource-allocation timeout value), and PID format, must be the same on EX\_Ports or VEX\_Ports and on the fabrics to which they are connected. You can set the PID format on an EX\_Port when you configure an inter-fabric link.

The default values for E\_D\_TOV and R\_A\_TOV for an EX\_Port or VEX\_Port must match those values on other Fabric OS switches. You do not need to adjust these parameters for an EX\_Port or VEX\_Port unless you have adjusted them for the edge fabric.

The default values for R\_A\_TOV and E\_D\_TOV are the recommended values for all but very large fabrics (ones requiring four or more hops) or high-latency fabrics (such as ones using long-distance FCIP links).

## Inter-fabric broadcast frames

The FC router can receive and forward broadcast frames between edge fabrics and between the backbone fabric and edge fabrics. Many target devices and HBAs cannot handle broadcast frames. In this case, you can set up broadcast zones to control which devices receive broadcast frames. (See [“Broadcast zones”](#) on page 244 for information about setting up broadcast zones.)

By default, broadcast frames are *not* forwarded from the FC router to the edge fabrics.

---

### NOTE

Broadcast frame forwarding is not supported in an FCR fabric with a Brocade 8000. By default, broadcast frame forwarding is disabled on an FC router. If your edge fabric includes a Brocade 8000, do not enable broadcast frame forwarding on the FC router, because this can degrade FCR performance when there is excessive broadcast traffic.

---

## Displaying the current broadcast configuration

1. Log in to the FC router as admin.
2. Type the following command:

```
for:admin> fcrbcastconfig --show
```

This command displays only the FIDs that have the broadcast frame option enabled. The FIDs that are not listed have the broadcast frame option disabled.

## Enabling broadcast frame forwarding

1. Log in to the FC router as admin.
2. Type the following command:

```
fcr:admin> fcrbcastconfig --enable -f fabricID
```

where *fabricID* is the FID of the edge or backbone fabric on which you want to enable broadcast frame forwarding. Broadcast frame forwarding is enabled by default.

## Disabling broadcast frame forwarding

1. Log in to the FC router as admin.
2. Type the following command:

```
fcr:admin> fcrbcastconfig --disable -f fabricID
```

where *fabricID* is the FID of the edge or backbone fabric on which you want to disable broadcast frame forwarding.

# Resource monitoring

It is possible to exhaust resources, such as proxy PIDs. Whenever a resource is exhausted, Fabric OS generates an error message. The messages are described in the *Fabric OS Message Reference*.

You can monitor FC router resources using the **fcrResourceShow** command. The **fcrResourceShow** command shows FCR resource limits and usage and includes the following:

- LSAN zones and LSAN devices — The information shows the maximum versus the currently used zones and device database entries. Each proxy or physical device constitutes an entry. If LSAN zones are defined in two edge fabrics, they are counted as two and not one. One device imported into multiple edge fabrics counts multiple times.

The default maximum number of LSAN zones is 3000. See [“Setting the maximum LSAN count”](#) on page 480 for information on changing this limit.

- Proxy Device Slots — The physical and proxy devices use the 10000 device slots. The information shows the maximum pool size for translate phantom node and port WWNs and shows the number of translate node and port WWNs from this pool.
- Phantom Node WWNs
- Phantom Port WWNs
- Max proxy devices
- Max NR\_Ports

The following example shows the use of the **fcrResourceShow** command to display physical port (EX\_Port) resources.

```
switch:admin> fcrresourceshow
Daemon Limits:
                Max Allowed      Currently Used
-----
LSAN Zones:           3000             28
```

```

LSAN Devices:          10000          51
Proxy Device Slots:   10000          20

                                WWN Pool Size          Allocated
                                -----
Phantom Node WWN:     8192           5413
Phantom Port WWN:    32768          16121

Port Limits:
Max proxy devices:   2000
Max NR_Ports:       1000

Currently Used(column 1: proxy, column 2: NR_Ports):
 0 |      0      34
 1 |      3      34
 4 |      0       0
 5 |      0       0
 6 |      0       0
 7 |      0       0
 8 |      6      34
 9 |      6      34
10 |      6      34
11 |      6      34
12 |      6      34
13 |      6      34
14 |      6      34
15 |      6      34
16 |      8      34
17 |      8      34
18 |      8      34
19 |      8      34
20 |      8      34
21 |      8      34
22 |      8      34
23 |      8      34

```

## FC-FC Routing and Virtual Fabrics

If Virtual Fabrics is not enabled, FC-FC routing behavior is unchanged. If Virtual Fabrics is enabled, then in the FC-FC routing context, a base switch is like a backbone switch and a base fabric is like a backbone fabric.

If Virtual Fabrics is enabled, the following rules apply:

- EX\_Ports and VEX\_Ports can be configured only on the base switch.

When you enable Virtual Fabrics, the chassis is automatically rebooted. When the switch comes up, only one default logical switch is present, with the default fabric ID (FID) of 128. All previously configured EX\_Ports and VEX\_Ports are persistently disabled with the reason "ExPort in non base switch". You must explicitly create a base switch, move the EX\_ and VEX\_Ports to the base switch, and then enable the ports.

If you move existing EX\_ or VEX\_Ports to any logical switch other than the base switch, these ports are automatically disabled.

If you want to change an EX\_ or VEX\_Port on the logical switch to be a non-EX or VEX\_Port, you must use the **portCfgDefault** command. You cannot use the **portCfgExPort** command because that command is allowed only on the base switch.

- EX\_Ports can connect to a logical switch that is in the same chassis or a different chassis. However, the FID of the EX\_Port must be set to a different value than the FID of the logical switch to which it connects.
- EX\_Ports and VEX\_Ports – those in FC routers and those in a base switch – cannot connect to any edge fabric with logical switches configured to use XISLs.

If you connect an EX\_Port or VEX\_Port to an edge fabric, you must ensure that there are no logical switches with XISL use enabled in that edge fabric. If any logical switch in the edge fabric allows XISL use, then the EX\_Port or VEX\_Port is disabled. See [“Configuring a logical switch to use XISLs”](#) on page 232 for instructions on disallowing XISL use.

Since XISL use is disallowed, dedicated links must be configured to route traffic across switches in the same logical fabric, as shown in [Figure 26](#) on page 215.

---

#### ATTENTION

If you connect an EX\_Port or VEX\_Port from an FC router running Fabric OS v6.1.x or earlier to a logical switch that allows XISL use, the EX\_Port or VEX\_Port is *not* disabled; however, this configuration is not supported.

---

- Backbone-to-edge routing is not supported in the base switch. See [“Backbone-to-edge routing with Virtual Fabrics”](#) on page 494 for information about how to configure FC routers to allow backbone-to-edge routing with Virtual Fabrics.
- If you connect an FC router in legacy mode to a base switch, you must set the backbone FID of the FC router to be the same as that of the base switch.
- All FCR commands can be executed only in the base switch context.
- The **fcrConfigure** command is not allowed when Virtual Fabrics is enabled. Instead, use the **IsCfg** command to configure the FID.

## Logical switch configuration for FC routing

For example, [Figure 76](#) shows two chassis partitioned into logical switches. This configuration allows the device in Fabric 128 to communicate with the device in Fabric 15 without merging the fabrics. Note the following:

- The base switch in Physical chassis 1 serves as an FC router and contains EX\_Ports that connect to logical switches in the two edge fabrics, Fabric 128 and Fabric 15.
- The other logical switches in Fabric 128 and Fabric 15 must be connected with physical ISLs, and do not use the XISL connection in the base fabric.
- The logical switches in Fabric 1 are configured to allow XISL use. You cannot connect an EX\_Port to these logical switches, so the device in Fabric 1 cannot communicate with the other two devices.

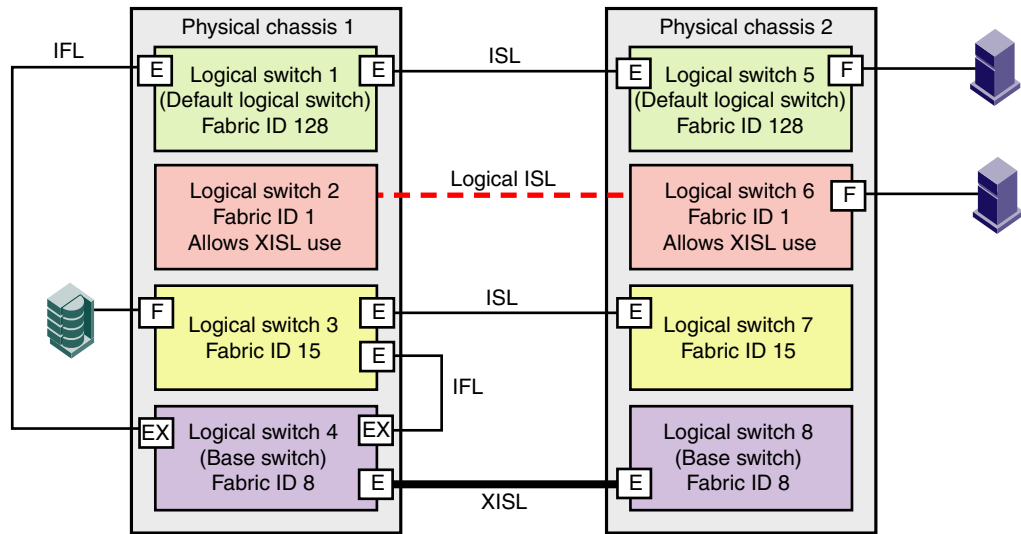

FIGURE 76 EX\_Ports in a base switch

Figure 77 shows a logical representation of the physical chassis and devices in Figure 76. As shown in Figure 77, Fabric 128 and Fabric 15 are edge fabrics connected to a backbone fabric. Fabric 1 is not connected to the backbone, so the device in Fabric 1 cannot communicate with any of the devices in the other fabrics.

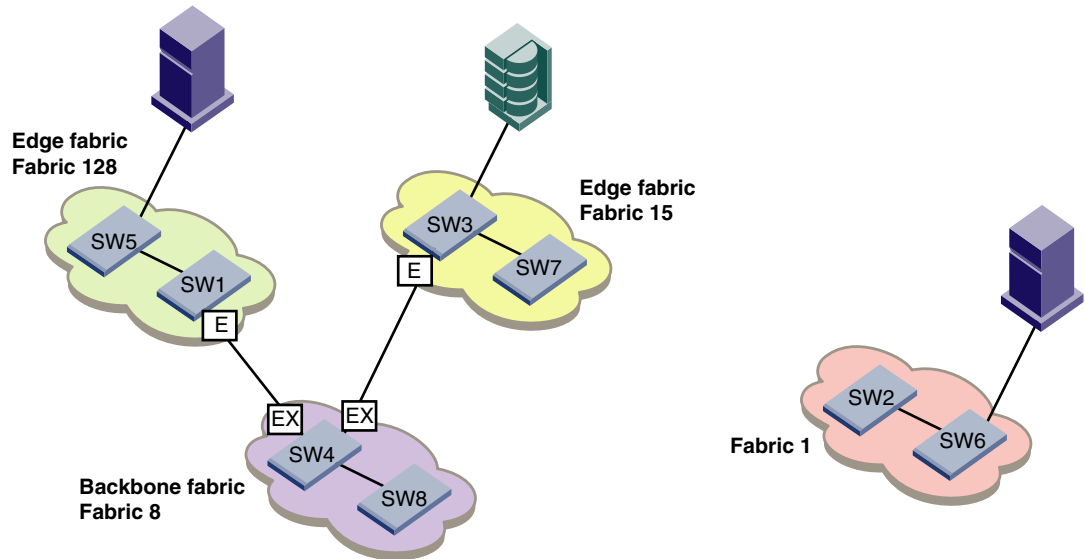

FIGURE 77 Logical representation of EX\_Ports in a base switch

## Backbone-to-edge routing with Virtual Fabrics

Since the base switch does not allow F\_Ports, you cannot have devices connected to the base switch.

Even though F\_Ports are not allowed in the base switch, they are allowed in an FC router in legacy mode (Fabric OS v6.1.x or earlier, or Fabric OS v6.2.0 or later with Virtual Fabrics disabled). If you connect an FC router in legacy mode to the base switch, backbone-to-edge routing is supported on that FC router.

In [Figure 76](#), no devices can be connected to the backbone fabric (Fabric 8) because base switches cannot have F\_Ports. [Figure 78](#) shows an FC router in legacy mode connected to a base switch. This FC router *can* have devices connected to it, and so you can have backbone-to-edge routing through this FC router. In this figure, Host A in the backbone fabric can communicate with device B in the edge fabric with FID 20; Host A cannot communicate with device C, however, because the base switches do not support backbone-to-edge routing.

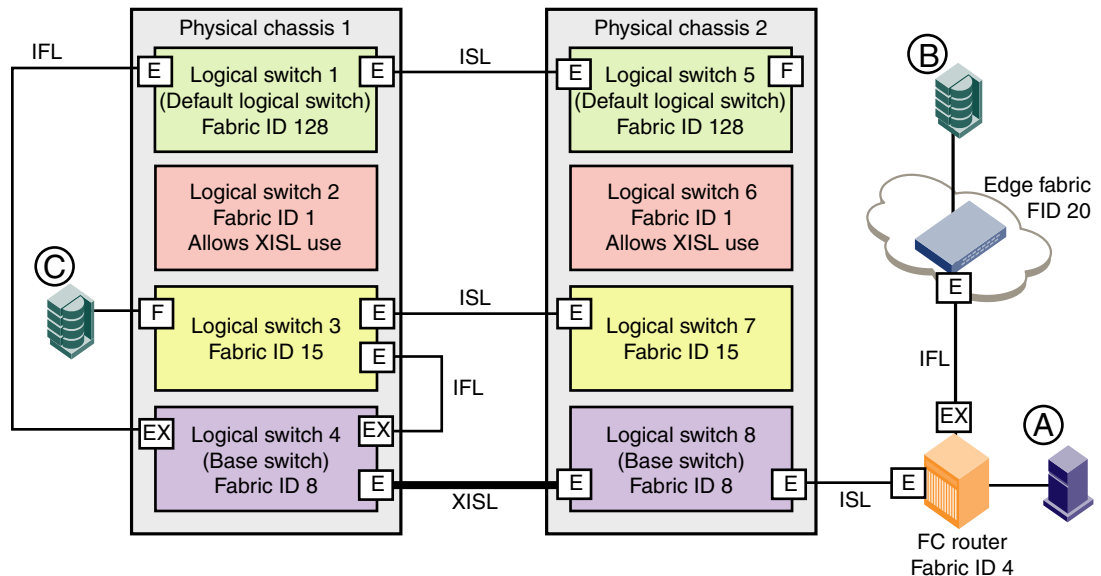

FIGURE 78 Backbone-to-edge routing across base switch using FC router in legacy mode

## Upgrade and downgrade considerations for FC-FC routing

When you upgrade to Fabric OS v6.4.0 or later, EX\_Ports remain functional and you can continue to perform all FC router operations on the switch.

Brocade recommends that you save your FC-FC routing configuration (using the `configUpload` command) before performing any downgrades.

For further instructions on downgrading, refer to [Chapter 9, “Installing and Maintaining Firmware”](#).

### How replacing port blades affects EX\_Port configuration

If you replace an FR4-18i blade with an 8-Gbps port blade or FX8-24 blade, the EX\_Port configuration remains the same for the first 16 ports on the 8-Gbps port blade (and for the first 12 FC ports on the FX8-24 blade). For all other ports on the blade, the EX\_Port configuration is cleared. No ports are persistently disabled.

## 21 Displaying the range of output ports connected to xlate domains

If you replace an 8-Gbps port blade or FX8-24 blade with an FR4-18i blade, the EX\_Port configuration remains the same for all ports on the FR4-18i blade. All ports are persistently disabled.

If you replace an 8-Gbps port blade with an FX8-24 blade, the EX\_Port configuration remains the same for the first 12 FC ports on the FX8-24 blade.

If you replace an 8-Gbps port blade or FX8-24 blade with another 8-Gbps port blade, the EX\_Port configuration remains the same.

## Displaying the range of output ports connected to xlate domains

The edge fabric detects only one front domain from an FC router connected through multiple output ports. The output port of the front domain is not fixed to 0; the values can be in a range of 129–255. The range of the output ports connected to the xlate domain is 1–128. This range enables the front domain to connect to 127 remote xlate domains.

1. Log in to a switch in the edge fabric.
2. Enter the **lsDbShow** command on the edge fabric.

In the **lsDbShow** output, ports in the range of 129–255 are the output ports on the front domain.

The following example shows the range of output ports.

```
linkCnt = 2,    flags = 0x0
LinkId = 53, out port = 1, rem port = 35, cost = 500, costCnt = 0, type = 1
LinkId = 57, out port = 129, rem port = 18, cost = 500, costCnt = 0, type = 1
```

The following example also shows the use of the **lsDbShow** display on the edge fabric. The front domain, domain 3, has two links representing two EX\_Port connections with output ports 129 and 132.

```
Domain = 3, Link State Database Entry pointer = 0x100bbcc0
.....
linkCnt = 4,    flags = 0x0
LinkId = 199, out port = 129, rem port = 2, cost = 10000, costCnt = 0, type = 1
LinkId = 199, out port = 132, rem port = 3, cost = 10000, costCnt = 0, type = 1
LinkId = 2, out port = 1, rem port = 2, cost = 10000, costCnt = 0, type = 1
LinkId = 1, out port = 32, rem port = 2, cost = 10000, costCnt = 0, type = 1
```



# M-EOS Migration Path to Fabric OS

## In this appendix

- [M-EOS fabrics overview](#) . . . . . 497
- [McDATA Mi10K interoperability](#) . . . . . 499
- [Fabric configurations for interconnectivity](#) . . . . . 499

## M-EOS fabrics overview

This appendix covers how to set up your Fabric OS SAN and M-EOS SAN to route traffic without merging the two SANs. If you want to merge the SANs or use SANtegrity, refer to [Chapter 14, “Interoperability for Merged SANs,”](#) for more information.

The FC router interoperates with M-EOS fabrics in both McDATA Open Mode and McDATA Fabric Mode. Fabric OS provides the ability to configure any EX\_Port to connect to an M-EOS fabric by using an E\_Port without disrupting the existing services. All the EX\_Port functionality, such as fabric isolation and device sharing, remains the same as when connecting to an existing Fabric OS fabric.

### NOTE

M-EOS fabrics are supported only as edge fabrics and are not supported as backbone fabrics.

Fabric OS interoperates with M-EOS edge fabrics in McDATA Fabric Mode and Open Mode and supports backbone-to-edge and edge-to-edge routing. [Table 96](#) outlines which releases of Fabric OS are compatible with which releases of M-EOS.

**TABLE 96** Fabric OS and M-EOSc interoperability compatibility matrix<sup>1</sup>

Fabric OS	Versions of M-EOSc							
	v6.2.0	v7.1.3x	v8.0	v9.2.0	v9.6.2	v9.7	v9.8	v9.9
v5.1.0 <sup>2</sup>	Yes	No	No	No	No	No		
v5.2.0	No	Yes	Yes	No	No	No		
v5.3.0	No	No	Yes	Yes	No	No		
v6.0.0	No	No	No	No	Yes	No		
v6.1.0	No	No	No	No	Yes	Yes		
v6.1.1								
v6.1.1_enc								
v6.2.0							Yes	Yes

**TABLE 96 Fabric OS and M-EOSc interoperability compatibility matrix<sup>1</sup> (Continued)**

Fabric OS	Versions of M-EOSc							
	v6.2.0	v7.1.3x	v8.0	v9.2.0	v9.6.2	v9.7	v9.8	v9.9
v6.3.0							Yes	Yes
v6.4.0							Yes	Yes

- Both Open and McDATA Fabric modes are supported.
- Fabric OS v5.1.0 and M-E/OSc v4.1.1, v5.1.2, 6.2.0 can interoperate through the FC routing capability of the SilkWorm AP7420 only. Fabric OS and M-E/OSc v7.1.3 can interoperate through the FC routing capability of the SilkWorm AP7420, Brocade 7500, or FR4-18i blade. Fabric OS and M-E/OSc v8.0.0 and v9.2.0 can interoperate through the FC routing capability of the Brocade 7500, or FR4-18i blade.

The Fibre Channel routing feature for M-EOS interoperability is not a licensed feature.

**TABLE 97 Fabric OS and M-EOSn interoperability compatibility matrix<sup>1</sup>**

Fabric OS	Versions of M-EOSn (i10k)			
	v9.2.0	v9.6.2	v9.8.0	v9.9.0
v5.3.0	Yes	No	No	No
v6.0.0	No	Yes	No	No
v6.1.0	No	Yes	No	No
v6.1.1		Yes	No	No
v6.1.1_enc		Yes	No	No
v6.2.0	No	Yes	Yes	Yes
v6.3.0	No	Yes	Yes	Yes
v6.4.0	No	Yes	Yes	Yes

- Both Open and McDATA Fabric modes are supported.

Connected SANs provide additional functionality not possible with segregated SANs. Some of these functions are as follows:

- Island consolidation—Uses the Fabric OS v6.0 or later FC router to connect isolated M-EOS and Fabric OS fabrics and share devices.
- Backup consolidation—Consolidates backup solutions across Fabric OS and M-EOS fabrics.
- Manageable large-scale storage network—Uses the Fabric OS v6.0 or later FC router to localize traffic while connecting devices in the metaSAN. This provides a large number of fabrics with a large number of devices.
- Sharing across an FCIP link—Shares devices between Fabric OS and M-EOS fabrics over a campus Ethernet or over long-distance IP links beyond 1000 km.
- Sharing across a long-distance FC link—Shares devices between Fabric OS fabrics over long-distance FC links as far as 300 km.
- LUN sharing—Uses your high-end RAID array connected to an M-series to share targets with a Fabric OS fabric; just connect one Intrepid series port to an FC router EX\_Port and the one EX\_Port to the Fabric OS edge fabric.
- LSAN zone database binding—Increases FCR scalability to support more FC routers in the backbone and support more devices in the metaSAN.

The connectivity limitations of a metaSAN containing Fabric OS and M-EOS fabrics are defined by the scalability of each individual fabric. The latest scalability information can be found at the Brocade Connect Web site at [www.brocade.com](http://www.brocade.com). Refer to the M-EOS fabric documentation for scalability considerations.

## McDATA Mi10K interoperability

When an EX\_Port is connected to an M-EOS edge fabric, the front domain ID must be within a range the edge M-Series switch can understand. Valid values are:

- McDATA Native mode: 1 – 31 (IM2)
- McDATA Open mode: 97-127 (for IM3)
- McDATA Open mode: 1- 239 (specifically for the i10k in McDATA Open mode)

The default front domain ID assigned to the EX\_Port remains at 160 when it is created. However, when the EX\_Port is connected to the Mi10K, a daemon sends a request domain ID (RDI) command that must be within the valid range M-EOS understands.

When an RDI command is sent to an Mi10k switch with a valid domain ID defined by standards and is not within the range an Mi10k switch understands, the RDI request is rejected. This behavior of the Mi10k is different from other M-EOS switches.

If you set a front domain ID that is not within the valid range M-EOS understands, then in Fibre Channel routing, a daemon internally requests a valid domain ID that M-EOS understands. Unless you change the front domain ID, there is no impact.

The behavior with non-Mi10k switches displays the regular switch when configured.

After the port is properly configured and connected, running **switchShow** on the FC router displays the M-EOS switch that is connected. From the M-EOS side, the EOSc **show fabric topology** command displays the front domain in WWN format (for example, 10:00:00:05:1e:7e:a9:f6). If the LSAN is configured and proxy devices are created, the proxy device appears in the Name Server of the edge fabric, and the translate domain appears in the edge fabric. On M-EOSn the **fc show fabric 1** command displays the front domain in WWN format, like in EOSc. The same is true for the translate domain, but the vendor will display as *Unknown*.

## Fabric configurations for interconnectivity

When connecting a Fabric OS fabric with an M-EOS fabric using an FC Router, you must configure the switch on both fabrics as well as the router, as described in the following sections.

---

### NOTE

Trunking is not supported on EX\_Ports connected to the M-EOS fabric.

---

## Connectivity modes

You can connect to M-EOS fabrics in both McDATA Open mode or McDATA Fabric mode. If the mode is not configured correctly, the port is disabled because of incompatibility.

To allow interconnectivity with M-EOS SANs, use the **-m** option on the **portCfgEXPort** command to indicate the connectivity mode. [Table 98](#) lists the valid parameters to use with the **-m** option to set the connectivity mode.

**TABLE 98 portCfgEXPort -m values**

Value	Description	Use
0	Brocade Native	Default mode.
1	McDATA Open Mode 1	When the neighboring M-EOS switch is running in open mode.
2	McDATA Fabric Mode (native mode)	When the neighboring M-EOS switch is running in native mode.
3	McData Fabric legacy mode	Not currently used.

You can display the current operational mode of the EX\_Port by issuing the **portCfgExPort** command with the port number as the only parameter.

The following command sequence is an example to connect port 5 to an M-EOS fabric in McDATA Fabric Mode:

```
switch:admin> portdisable 5
switch:admin> portcfgexport 5 -m 2
switch:admin> portenable 5
```

See [“Inter-fabric link configuration”](#) on page 468 for details about the **portCfgExPort** command, which is used for McDATA Fabric mode on Fabric OS v5.2.0 or later.

## Configuring the FC router

When configuring a Fabric OS fabric to connect to a Native McDATA fabric, you must perform some preparation on the FC router. The following procedure shows how to connect an EX\_Port of an FC router to a Native McDATA fabric configured in Fabric mode.

### NOTE

For additional information on configuring the FC router, refer to [Chapter 21, “Using the FC-FC Routing Service”](#).

1. To verify the Native McDATA firmware version, use the M-EOS **show system** command.
2. To display the front domain on the M-EOS fabric, use the M-EOS **showfabric topology** command.
3. Using the **Fabric OS firmwareShow** command, make sure that Fabric OS v6.4.0 or later is installed on the FC router, as shown in the following example:

```
B7800_170:admin> firmwareshow
Appl      Primary/Secondary Versions
-----
FOS       v6.4.0
          v6.4.0
```

4. On the FC router, use the **portDisable** command to disable the EX\_Port that you will use to connect to the M-EOS switch. Ports are persistently disabled by default.
5. Enter the **portCfgExPort** command to configure the port as an EX\_Port with a different FID within the McDATA Fabric Mode.

This port can now connect to an M-EOS switch in McDATA Fabric mode or McDATA Open mode.

The following example sets port 10/13 to admin-enabled, assigns a Fabric ID of 37, and sets the M-EOS connection to McDATA Fabric Mode.

```
ecp:admin_06> portcfgexport 10/13 -a 1 -f 37 -m 2
```

6. Enable the port by issuing the **portEnable** command.

```
ecp:admin_06> portenable 10/13
```

If the port was persistently disabled, use the following command to enable the port:

```
ecp:admin_06> portcfgpersistentenable 10/13
```

7. Physically attach the IFLs from the FC router to the switches in the edge fabrics.
  - Connect IFL1 and verify EX\_Port connectivity. Repeat for all Fabric OS fabric IFLs.
  - Connect IFL (n) for the M-EOS fabric and verify EX\_Port connectivity. Repeat for all M-EOS fabric IFLs.
8. Log in to the FC router and enter the **switchShow** command to display the M-EOS switch that is connected to the FC router EX\_Port. You can now physically attach your ISLs from the FC router to other switches in the backbone fabric.

ISLs apply only to Fabric OS switches that are not connected as an edge fabric (IFLs). When an M-EOS switch is present, it is assumed that you are creating an edge fabric.

For information about Fabric OS edge fabric setup on E\_Ports and interswitch linking, see [Chapter 19, "Managing Trunking Connections"](#). For information on EX\_Port Frame trunking setup on the FC router, see ["Configuring EX\\_Port frame trunking"](#) on page 476.

9. Capture a SAN profile of the M-EOS and Fabric OS SANs, identifying the number of devices in each SAN.

By projecting the total number of devices and switches expected in each fabric when the LSANs are active, you can quickly determine the status of the SAN by issuing the commands **nsAllShow** and **fabricShow** on the Fabric OS fabric. The **nsAllShow** displays the global name server information and **fabricShow** displays the fabric membership information. The following examples illustrate the use of these commands.

An arrow (>) next to the switch symbolic name indicates the principal switch.

```
switch:admin_06> fabricshow
Switch ID      Worldwide Name          Enet IP Addr      FC IP Addr        Name
-----
64: fffc40 10:00:00:60:69:00:06:56 192.168.64.59     192.168.65.59     "sw5"
65: fffc41 10:00:00:60:69:00:02:0b 192.168.64.180   192.168.65.180   >"sw180"
66: fffc42 10:00:00:60:69:00:05:91 192.168.64.60    192.168.65.60    "sw60"
67: fffc43 10:00:00:60:69:10:60:1f 192.168.64.187   0.0.0.0          "sw187"
```

The Fabric has 4 switches

You can use DCFM to gather similar information for the M-EOS fabric. See the *EFC Manager Software User Manual* for information using DCFM.

When you have configured the FC router to connect to a fabric, you must create LSAN zones for the SAN. After you set up LSAN zoning, issue the **cfgShow** command to verify that the zoning is correct.

## Configuring LSAN zones in the M-EOS fabric

To ensure connectivity with devices in the Fabric OS fabric, you must set up LSAN zones in each edge fabric.

An LSAN is defined by a zone in an edge fabric. When zoning an LSAN containing multiple fabrics with switches that are not running Fabric OS, you must use port WWN. Because port IDs are not necessarily unique across fabrics, you cannot use the *domain,port* method of identification.

If the LSAN is configured and the proxy devices are created, the proxy device will show in the name server of the edge fabric and the xlate domain will show in the fabric of the edge fabric.

For more details about LSAN zoning, see “[LSAN zone configuration](#)” on page 477.

The FC router can support up to 2048 zones when connected to an M-EOS v9.6 switch.

---

### NOTE

For detailed instructions for the steps in the following procedure, refer to the *Zoning User Manual*. <http://www.brocade.com/data-center-best-practices/resource-center> web site under the Data Center Best Practices-Resource Center section and follow the instructions to access the documentation.

---

1. Log in to DCFM.
2. Create a new LSAN zone, as described in the *Zoning User Manual*. The name of the zone must use the LSAN\_xxxx naming schema.
3. Add devices that are connected to the Fabric OS fabric. Use the device WWN when adding devices.
4. Add the newly created zone to the currently active zone set.
5. Activate the updated zone set.

## Correcting errors if LSAN devices appear in only one of the fabrics

If the LSAN devices appear in only one of the fabrics in a multiple-fabric SAN, use the following procedure to correct the problem.

1. Log in to each fabric and verify that all of the devices are physically logged in.
2. Verify that the devices are properly configured in the LSAN zone in both edge fabrics.
3. Enter the **fabricShow** command on the Fabric OS fabric.
4. Use M-EOS DCFM to verify the M-EOS fabric, including the front and translation domains.
5. Move back to the FC router and issue the **fcrProxyDevShow** command on to verify that the devices are configured and exported.

```
switch:admin> fcrproxydevshow
```

Proxy Created in Fabric	WWN	Proxy PID	Device Exists in Fabric	Physical PID	State
10	20:00:00:01:73:00:59:dd	05f001	12	610902	Imported
10	21:00:00:e0:8b:04:80:76	02f002	11	340713	Imported
10	50:06:01:68:40:04:d3:95	02f001	11	660713	Imported
11	10:00:00:00:c9:2d:3d:5c	020001	10	011500	Imported

6. Connect to the switch and configure the connection to capture console output.
7. Enter the **supportShow** (or **supportSave** if available) command, and save the output.
8. If the fabric does not appear:
  - a. Disable the EX\_Port on the connected fabric.
  - b. Enter the **portLogClear** command for the port.
  - c. Enable the port on the FC router.
  - d. Enter the **portLogDump** command for the port, capturing the output.

Use the **portLogDump** tool to troubleshoot the problem, using the command output.

If an EX\_Port connecting an FC router and an edge fabric is disabled due to an error, the error causing that port's most recent disabled state appears in the **switchShow** command output. This error appears until that port comes back online, even after the cables have been detached from the port.

To remove the error listing in the **switchShow** output, reboot the FC router. An example of the type of error displayed is 'Incompatible port mode'.

## Completing the configuration

After you prepare the M-EOS switch and the FC router for use, complete the configuration using the following procedure.

1. Physically connect the EX\_Port that you configured for the Fabric OS switch to the FC router.
2. Log in to the Fabric OS switch as an admin.
3. Physically connect the configured FC router EX\_Port to the M-EOS switch, and issue the **switchShow** command on the Brocade FC router.

New domains should be visible for each IFL (front domain) that connects the Fabric OS switch to the FC router and one domain for the translate domain.

4. Start DCFM and select the fabric for the M-EOS switch.
5. View the fabric topology.

New domains should be visible for each FC router connected to the M-EOS switch. Multiple connections from the same FC router appear as only a single domain. New domains also appear for every translate domain that was created to import a remote device.

In DCFM, the M-EOS switch should appear green. Tab to **Zone** and verify that the zone set configuration is correct: a blue icon beside each entry indicates that the devices are logged in to the fabric.

6. Log in to the Fabric OS edge fabric switch and enter the **nsAllShow** or the **nsCamShow** command.

```
edgeswitch:admin> nsallshow
{
010e00 020000 03f001 04f002
4 Nx_Ports in the Fabric }

edgeswitch:admin> nscamshow
nscam show for remote switches:
Switch entry for 1
```

## A Fabric configurations for interconnectivity

```
state rev owner
known v520 0xffffc02
Device list: count 1
  Type Pid COS PortName NodeName
  N 010e00; 3;10:00:00:00:00:01:00:00;10:00:00:00:00:00:01:00;
  Fabric Port Name: 20:0e:00:60:69:e2:18:b6
  Permanent Port Name: 10:00:00:00:00:01:00:00
  Port Index: 14
  Share Area: No
  Device Shared in Other AD: No

Switch entry for 3
state rev owner
known v410 0xffffc02
Device list: count 1
  Type Pid COS PortName NodeName
  N 03f001; 2,3;10:00:00:00:c9:44:54:04;20:00:00:00:c9:44:54:04;
  FC4s: FCP
  NodeSymb: [36] "Emulex LP9002 FV3.92A2 DV5-5.10A10 "
  Fabric Port Name: 50:00:51:e3:70:9a:3d:e8
  Permanent Port Name: 10:00:00:00:c9:44:54:04
  Port Index: na
  Share Area: No
  Device Shared in Other AD: No

Switch entry for 4
state rev owner
known v410 0xffffc02
Device list: count 1
  Type Pid COS PortName NodeName
  N 04f002; 3;10:00:00:00:00:03:00:00;10:00:00:00:00:00:00:03:00;
  Fabric Port Name: 50:06:06:91:23:45:6a:13
  Permanent Port Name: 10:00:00:00:00:03:00:00
  Port Index: na
  Share Area: No
  Device Shared in Other AD: No
```

All of the devices from both LSANs should appear in the output. If the devices do not appear in the output, issue the **cfgShow** command to verify your zone configuration. Use the **cfgactvshow** command to display the zone configuration currently in effect. The following example illustrates the use of **cfgactvshow**.

```
switch:admin> cfgactvshow
Effective configuration:
  cfg:test
  zone:lsan_san
  10:00:00:00:00:03:00:00
  10:00:00:00:00:01:00:00
  zone:lsan_test
  50:06:01:60:38:e0:0b:a4
  10:00:00:00:c9:44:54:04
```

7. Log into the FC router and run the **lsanZoneShow -s** command to verify FIDs and devices to be shared among LSANs.



# Inband Management

---

## In this appendix

- [Inband Management overview](#) . . . . . 505
- [Internal Ethernet devices](#) . . . . . 506
- [IP address and routing management](#) . . . . . 506
- [Examples of supported configurations](#) . . . . . 509

## Inband Management overview

Inband Management on the Brocade 7500 Extension Switch allows a management station to communicate to the CP through the GE ports for tasks such as downloading firmware, SNMP polling, SNMP traps, troubleshooting, and configuration. To facilitate this communication, the Brocade 7500 Extension Switch uses IP forwarding and IP routing to forward IP traffic through the switch to the management station.

---

**NOTE**

You can have an FCIP tunnel set up and running on one GE port, while the other is being used for Inband Management. Or, you can use both GE ports for Inband Management.

---

Inband Management is implemented on the Brocade 7500 Extension Switch only and is not available on the FR4-18i blades. It requires having management access to the switch through the management port for initial configuration. There must be at least one IP interface configured, on the GE port you will use, for Inband Management.

To implement Inband Management on the Brocade 7500 Extension Switch, you must have an understanding of implementing IP routes and subnets. The GE port that you configure acts as a router with IP forwarding implemented to allow communication to the CP through the GE port processors and then out the GE ports. Therefore, it is necessary to implement numerous IP routes throughout the network to allow the communication to take place.

---

**NOTE**

IPsec is not supported over Inband Management interfaces.

---

Once the switch is set up with the appropriate IP addresses and routes, the IP driver will compare the destination address to any existing interfaces when it receives an IP packet. If it does not have an interface that matches, it will perform a route lookup for the destination address. If it returns with a valid gateway, the packet will be forwarded to that gateway address.

---

**NOTE**

Only IPv4 forwarding is supported.

---

## Internal Ethernet devices

During the switch initialization process, a new internal Ethernet device is created. The devices created are *inbd0* and *inbd1*. Ethernet device *inbd0* is used to communicate through GE port 1 and *inbd1* is used to communicate through GE port 0. These new Ethernet interfaces are internal only and are not accessible from outside the switch. They are used strictly for communicating IP packets between the CP and the GE port processor.

Figure 79 shows the Inband Management process. During initialization, the hardware addresses for *inbd0* and *inbd1* are initialized to create a hardware address that is unique for each Ethernet interface. After the Ethernet device is initialized, it is enabled for use. At this point, the Ethernet device can start sending and receiving Ethernet frames.

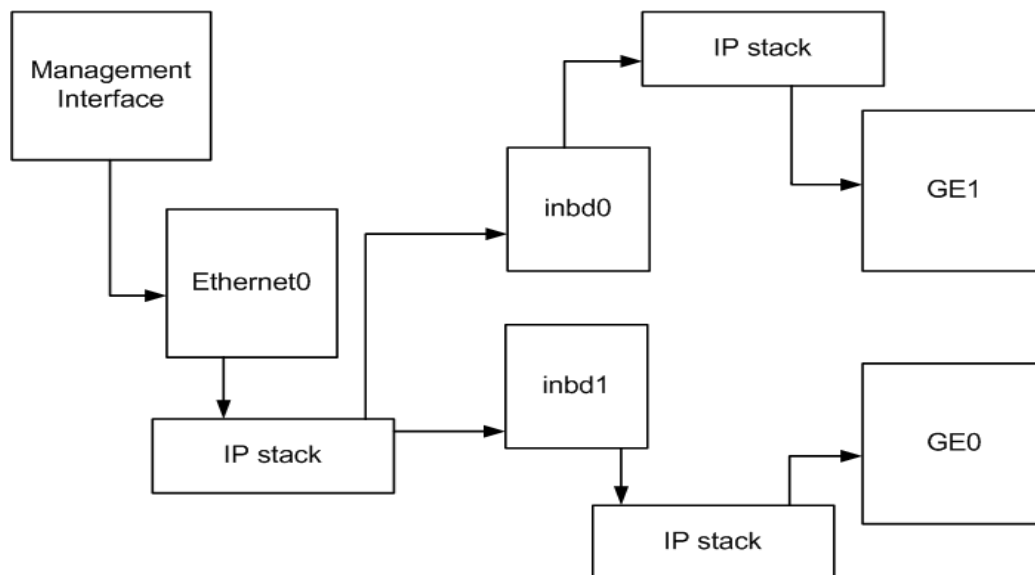

FIGURE 79 Inband Management process

The NAT IP table is loaded and automatically configured on startup. The source address NAT is configured on the Inband Management interfaces to use the address of the CP management interface (eth0). The switch automatically uses the IP address of the CP management interface for the source address NAT for the new Inband Management interfaces, so no additional configuration is required.

## IP address and routing management

The CP and GE port processor Ethernet interfaces must have IP addresses associated with them. By default, there will be no IP addresses associated with these new Ethernet interfaces. To manage the IP addresses for the CP and GE port processor Ethernet interfaces, use the **portCfg inbandmgmt** command on the CP.

Specifying the **portCfg inbandmgmt** command with the **routeadd** or **routedel** options adds and deletes route entries to and from the CP and the GE port processor routing tables. IP addresses must be configured for both devices prior to configuring any routes. When configuring the routes for the CP, the GE port processor inband device address for that GE port is used instead of the

specified gateway. If no gateway is specified, it is assumed that the management station is on the same subnet as the external GE IP address, so no route is created on the GE port processor. Only a route on the CP is created with the internal GE port processor inband device address as the gateway.

The routes configured using the **portCfg inbandmgmt** command behave differently than the normal routes configured using the **portCfg iproute** command, but the routes still use entries from the routing table. There is a limit of 40 total routes allowed to be configured for each GE port. Also note that the **portCfg inbandmgmt <port> routeadd** command must be configured even if the management station is attached to the same subnet as an IPIF on the GE port specified. This is because a route entry is still needed for the CP to be able to communicate.

## Setting the IP address for the 7500s

Setting the IP address on the GE port allows the 7500 to talk to the management station.

1. Connect to the switch and log in as admin.
2. Enter the **portCfg ipif** command to configure an IP address on the GE interface of each of the 7500s.

```
switch:admin> portcfg ipif ge0 create 192.168.3.10 255.255.255.0 1500
```

## Setting the IP address for the CP Inband Management interface

The **portCfg inbandmgmt** command stores the IP address of the CP Inband Management interface and routes in the configuration database and updates the current configuration to use these new settings. To add the IP address to the internal interface on the CP, use the **cp** option for the **portCfg inbandmgmt ipaddrset** command.

1. Connect to the switch and log in as admin.
2. Enter the **portCfg inbandmgmt** command to configure an IP address on the CP.

```
switch:admin> portcfg inbandmgmt ge0 ipaddrset cp 192.168.255.1 255.255.255.0
```

## Setting the IP address for the GE Inband Management interface

To set the IP address on the internal interface for the GE port processor, use the **ge** option for the **portCfg inbandmgmt ipaddrset** command. This command sets the appropriate interface based on the GE port number entered.

1. Connect to the switch and log in as admin.
2. Enter the **portCfg inbandmgmt** command to configure an IP address to the internal interface on the GE port processor.

```
switch:admin> portcfg inbandmgmt ge0 ipaddrset ge 192.168.255.2 255.255.255.0
```

## Adding an Inband Management route on the CP

1. Connect to the switch and log in as admin.
2. Enter the **portCfg inbandmgmt** command to add a route to the Management Station.

```
switch:admin> portcfg inbandmgmt ge0 routeadd 192.168.3.0 255.255.255.0
```

## Deleting an Inband Management route

1. Connect to the switch and log in as admin.
2. Enter the **portCfg inbandmgmt** command to delete a route to the Management Station.

```
switch:admin> portcfg inbandmgmt ge0 routedel 192.168.3.0 255.255.255.0
```

## Viewing Inband Management IP addresses and routes

The **portShow inbandmgmt** command displays the addresses that are currently configured for that GE port number and a status of Inband Management (Enabled/Disabled). To display the routing table, use the existing **portShow iproute** command. There is a status flag for the IP routes to signify if a route is used for the management interfaces. After the route definition is printed, a Management option appears at the end of the line. This indicates that the route is using one of the internal interfaces.

The **portCfgShow inbandmgmt** command displays the addresses that are currently configured for that GE port number. The **portCfgShow** command also displays any Inband Management routes configured in the Iproute Configuration section.

To provide connection between the CP and the management station, IP routes must be added to all Ethernet devices between the two. To make sure that only traffic destined for the management interface on the CP is sent to the Brocade 7500 Extension Switches, it is recommended you use host-specific routes for the Brocade 7500 management destination routes. This ensures that the Brocade 7500 Extension Switch is not acting as a full IP router between the various subnets. To ensure proper connectivity, routes must be added to each hop along the desired path.

### *Viewing Inband Management IP routes*

1. Connect to the switch and log in as admin.
2. Enter the **portShow iproute** command specifying the GE port you want to view.

The **portShow** command has additional information displayed in the iproute display option. The routes display the Management designation if they are routes associated with the CP-to-GE connectivity as shown below:

```
switch:admin> portshow iproute gel
```

```
Port: gel
IP Address      Mask           Gateway        Metric
-----
192.168.112.0   255.255.255.0 192.168.112.61 0      Interface
192.168.255.0   255.255.255.0 192.168.255.2   0      Interface Management
10.1.1.61       255.255.255.255 192.168.255.1   0      Management
192.168.102.0   255.255.255.0 192.168.112.1   0
192.168.106.0   255.255.255.0 192.168.112.1   0
192.168.255.0   255.255.255.0 192.168.255.1   0      Interface Management
192.168.112.60 255.255.255.255 192.168.255.2   0      Management
IPv6 Address    Len Gateway        Metric
```

In this example, the interface on the GE port processor is set up with an address of 192.168.255.2/24 and the address on inbd0 on the CP is set up with the address 192.168.255.1/24. There is an “Interface Management” route on the GE port processor for 192.168.255.0/24 with a gateway 192.168.255.2 and an “Interface Management” route on the

CP for 192.168.255.0/24 with gateway 192.168.255.1. Likewise, there is a “Management” route on the GE port processor for 10.1.1.61/32 with gateway 192.168.255.1, and a “Management” route on the CP for 192.168.112.60/32 with gateway 192.168.255.2. In this example, the CP management address is 10.1.1.61, and the “Management Station” is at address 192.168.112.60. If an additional route is needed on the GE port processor to communicate with the Management Station, this will not be labeled as a “Management” route because it does not use the internal devices as its gateway.

## FIPS

To maintain security while in FIPS mode, these devices will not function if FIPS mode is enabled. If these devices are configured and you try to enter FIPS mode, an error will occur. You must delete the configuration of these devices prior to entering FIPS mode.

## Examples of supported configurations

The following examples demonstrate how to set up your Brocade 7500 Extension Switches using two different network scenarios. These are only examples and you should substitute the IP addresses used in these examples with the ones given to you by your network administrator.

These examples use a Linux OS on the Management Station and routers. You must use the commands appropriate for the operating system of your Management Station and routers.

### Configuring a Management Station on the same subnet

This is an example of when the Management Station is on the same subnet as the GE ports on the Brocade 7500 Extension Switches. Using the network diagram shown in [Figure 80](#), the configuration would be set up as listed below.

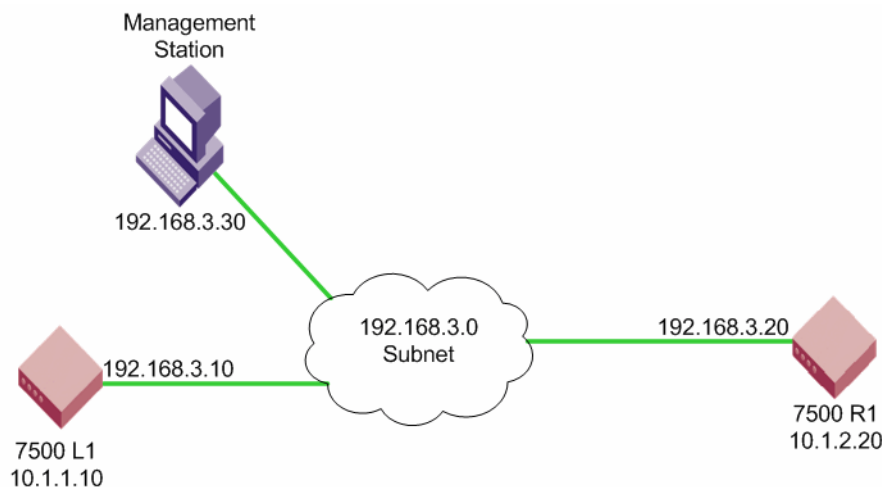

**FIGURE 80** Management Station on same subnet

1. Configure the IP address for each of the 7500s (L1 and R1):
  - a. On the 7500 L1, create an IP address on the GE interface:

```
switch:admin> portcfg ipif ge0 create 192.168.3.10 255.255.255.0 1500
```

## B Examples of supported configurations

- b. On the 7500 R1, create an IP address on the GE interface:

```
switch:admin> portcfg ipif ge0 create 192.168.3.20 255.255.255.0 1500
```

2. Configure the management interfaces on the 7500 L1.

- a. Configure the internal addresses for the inbd devices for CP and GE port (GE port 0 for this example).

```
switch:admin> portcfg inbandmgmt ge0 ipaddrset cp 192.168.255.1 255.255.255.0
switch:admin> portcfg inbandmgmt ge0 ipaddrset ge 192.168.255.2 255.255.255.0
```

- b. Add the route on the switch going to the Management Station.

```
switch:admin> portcfg inbandmgmt ge0 routeadd 192.168.3.0 255.255.255.0
```

3. Configure the management interfaces for the 7500 R1.

- a. Configure the internal addresses for the inbd devices for CP and GE port (GE port 0 for this example).

```
switch:admin> portcfg inbandmgmt ge0 ipaddrset cp 192.168.255.1 255.255.255.0
switch:admin> portcfg inbandmgmt ge0 ipaddrset ge 192.168.255.2 255.255.255.0
```

- b. Add the route on the switch going to the Management Station.

```
switch:admin> portcfg inbandmgmt ge0 routeadd 192.168.3.0 255.255.255.0
```

4. Configure the routes on the Management Station.

- a. Add the route on the Management Station that is going to the 7500 L1.

```
linux> route add -host 10.1.1.10 gw 192.168.3.10
```

- b. Add the route on the Management Station that is going to the 7500 R1.

```
linux> route ge0 -host 10.1.2.20 gw 192.186.3.20
```

## Configuring a Management Station on different subnets

For a configuration with multiple subnets, the routes must be added to all intermediate hops in the network as seen in [Figure 81](#) on page 511. To minimize the effect on IP traffic and limit the possibility that unnecessary access will be given, a host-specific route can be used on all routes specified for the Brocade 7500 Extension Switches. This will ensure that only IP traffic destined for the switches management addresses is routed to the Brocade 7500 Extension Switches and all other IP traffic that may be destined for that subnet will use a different path or get dropped if no other path is available. When adding routes to the management station, a host-specific route can be used, but is not necessary.

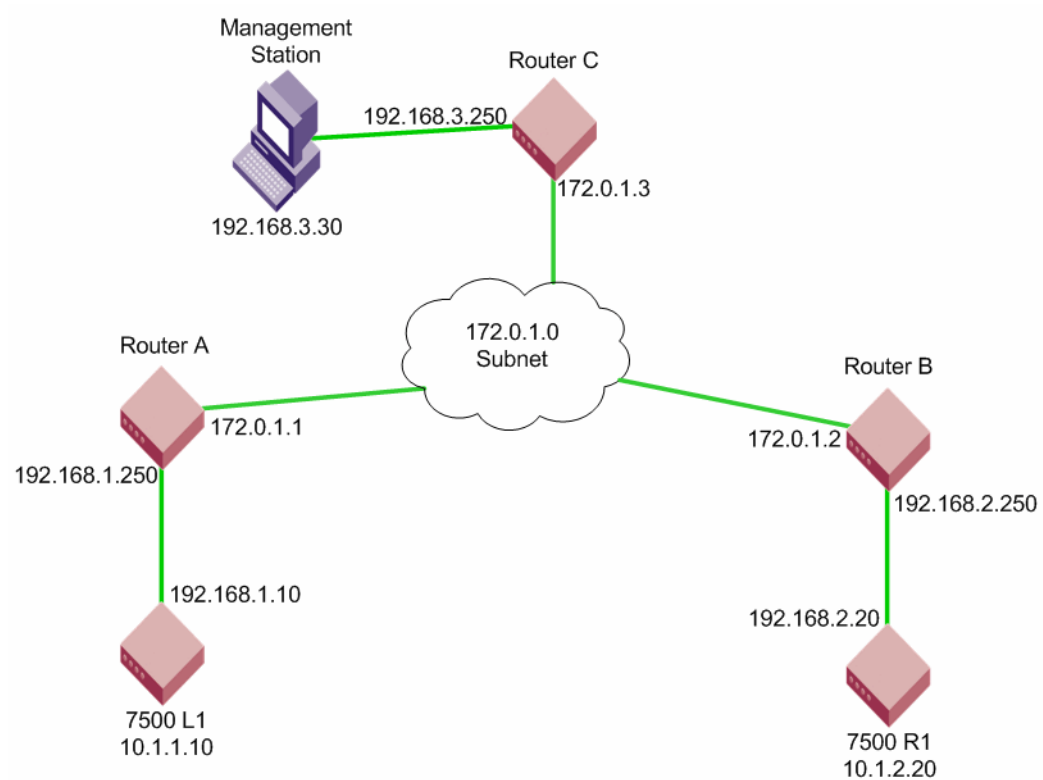

**FIGURE 81** Management Station on a different subnet

1. Configure the IP address for each of the 7500s (L1 and R1):
  - a. On the 7500 L1, create an IP address on the GE interface:
 

```
switch:admin> portcfg ipif ge0 create 192.168.1.10 255.255.255.0 1500
```
  - b. On the 7500 R1, create an IP address on the GE interface:
 

```
switch:admin> portcfg ipif ge0 create 192.168.2.20 255.255.255.0 1500
```
2. Configure the management addresses for the 7500 L1.
  - a. Configure the internal addresses for the inbd devices for CP and GE port (GE port 0 for this example).
 

```
switch:admin> portcfg inbandmgt ge0 ipaddrset cp 192.168.255.1 255.255.255.0
switch:admin> portcfg inbandmgt ge0 ipaddrset ge 192.168.255.2 255.255.255.0
```
  - b. Add the route on the switch going to the Management Station.
 

```
switch:admin> portcfg inbandmgt ge0 routeadd 192.168.3.0 255.255.255.0
192.168.1.250
```
3. Configure the management addresses for the 7500 R1.
  - a. Configure the internal addresses for the inbd devices for CP and GE port (GE port 0 for this example).
 

```
switch:admin> portcfg inbandmgt ge0 ipaddrset cp 192.168.255.1 255.255.255.0
switch:admin> portcfg inbandmgt ge0 ipaddrset ge 192.168.255.2 255.255.255.0
```
  - b. Add the route on the switch going to the Management Station.

## B Examples of supported configurations

```
switch:admin> portcfg inbandmgmt ge0 routeadd 192.168.3.0 255.255.255.0
192.168.2.250
```

### 4. Configure the routes on Router A.

- a. Configure the route going to the 7500 L1 management address.

```
linux> route add -host 10.1.1.10 gw 192.168.1.10
```

- b. Configure the route going to the Management Station.

```
linux> route add -net 192.168.3.0/24 gw 172.0.1.3
```

### 5. Configure the routes on Router B.

- a. Configure the route going to the 7500 R1 management address.

```
linux> route add -host 10.1.2.20 gw 192.168.2.20
```

- b. Configure the route going to the Management Station.

```
linux> route add -net 192.168.3.0/24 gw 172.0.1.3
```

### 6. Configure the routes on Router C.

- a. Configure the route going to the 7500 L1 management address.

```
linux> route add -host 10.1.1.10 gw 172.0.1.1
```

- b. Configure the route going to the 7500 R1 management address.

```
linux> route add -host 10.1.2.20 gw 172.0.1.2
```

### 7. Configure the Management Station.

- a. Configure the route going to the 7500 L1 management address.

```
linux> route add -host 10.1.1.10 gw 192.168.3.250
```

- b. Configure the route going to the 7500 R1 management address.

```
linux> route add -host 10.1.2.20 gw 192.168.3.250
```



# Port Indexing

## In this appendix

- [Port indexing on the Brocade 48000 director](#) ..... 513
- [Port indexing on the Brocade DCX backbone](#) ..... 515
- [Port indexing on the Brocade DCX-4S backbone](#) ..... 517

## Port indexing on the Brocade 48000 director

Table 99 shows the area\_ID and index mapping for core PID assignment for the Brocade 48000 director. There are up to 255 areas and the area\_ID mapping to the index is one-to-one. Beyond this, the index is similar but not exact, and in some instances, the area\_ID is shared among multiple ports.

This table provides the index/area\_ID assignment for the maximum number of ports used by the FC4-48 and FC8-48 blades. The FC8-64 is not supported on the Brocade 48000 director. If your blade does not have the maximum number of ports, use the lower sections of the table to determine the area\_ID and index.

**TABLE 99** Default index/area\_ID core PID assignment with no port swap for the Brocade 48000 director

Port on blade	Slot 1 Idx/area	Slot 2 Idx/area	Slot 3 Idx/area	Slot 4 Idx/area	Slot 7 Idx/area	Slot 8 Idx/area	Slot 9 Idx/area	Slot 10 Idx/area
47	271/135	287/151	303/167	319/183	335/199	351/215	367/231	383/247
46	270/134	286/150	302/166	318/182	334/198	350/214	366/230	382/246
45	269/133	285/149	301/165	317/181	333/197	349/213	365/229	381/245
44	268/132	284/148	300/164	316/180	332/196	348/212	364/228	380/244
43	267/131	283/147	299/163	315/179	331/195	347/211	363/227	379/243
42	266/130	282/146	298/162	314/178	330/194	346/210	362/226	378/242
41	265/129	281/145	297/161	313/177	329/193	345/209	361/225	377/241
40	264/128	280/144	296/160	312/176	328/192	344/208	360/224	376/240
39	263/143	279/159	295/175	311/191	327/207	343/223	359/239	375/255
38	262/142	278/158	294/174	310/190	326/206	342/222	358/238	374/254
37	261/141	277/157	293/173	309/189	325/205	341/221	357/237	373/253
36	260/140	276/156	292/172	308/188	324/204	340/220	356/236	372/252
35	259/139	275/155	291/171	307/187	323/203	339/219	355/235	371/251
34	258/138	274/154	290/170	306/186	322/202	338/218	354/234	370/250
33	257/137	273/153	289/169	305/185	321/201	337/217	353/233	369/249

## C Port indexing on the Brocade 48000 director

**TABLE 99** Default index/area\_ID core PID assignment with no port swap for the Brocade 48000 director (Continued)

Port on blade	Slot 1 Idx/area	Slot 2 Idx/area	Slot 3 Idx/area	Slot 4 Idx/area	Slot 7 Idx/area	Slot 8 Idx/area	Slot 9 Idx/area	Slot 10 Idx/area
32	256/136	272/152	288/168	304/184	320/200	336/216	352/232	368/248
31	143/143	159/159	175/175	191/191	207/207	223/223	239/239	255/255
30	142/142	158/158	174/174	190/190	206/206	222/222	238/238	254/254
29	141/141	157/157	173/173	189/189	205/205	221/221	237/237	253/253
28	140/140	156/156	172/172	188/188	204/204	220/220	236/236	252/252
27	139/139	155/155	171/171	187/187	203/203	219/219	235/235	251/251
26	138/138	154/154	170/170	186/186	202/202	218/218	234/234	250/250
25	137/137	153/153	169/169	185/185	201/201	217/217	233/233	249/249
24	136/136	152/152	168/168	184/184	200/200	216/216	232/232	248/248
23	135/135	151/151	167/167	183/183	199/199	215/215	231/231	247/247
22	134/134	150/150	166/166	182/182	198/198	214/214	230/230	246/246
21	133/133	149/149	165/165	181/181	197/197	213/213	229/229	245/245
20	132/132	148/148	164/164	180/180	196/196	212/212	228/228	244/244
19	131/131	147/147	163/163	179/179	195/195	211/211	227/227	243/243
18	130/130	146/146	162/162	178/178	194/194	210/210	226/226	242/242
17	129/129	145/145	161/161	177/177	193/193	209/209	225/225	241/241
16	128/128	144/144	160/160	176/176	192/192	208/208	224/224	240/240
15	15/15	31/31	47/47	63/63	79/79	95/95	111/111	127/127
14	14/14	30/30	46/46	62/62	78/78	94/94	110/110	126/126
13	13/13	29/29	45/45	61/61	77/77	93/93	109/109	125/125
12	12/12	28/28	44/44	60/60	76/76	92/92	108/108	124/124
11	11/11	27/27	43/43	59/59	75/75	91/91	107/107	123/123
10	10/10	26/26	42/42	58/58	74/74	90/90	106/106	122/122
9	9/9	25/25	41/41	57/57	73/73	89/89	105/105	121/121
8	8/8	24/24	40/40	56/56	72/72	88/88	104/104	120/120
7	7/7	23/23	39/39	55/55	71/71	87/87	103/103	119/119
6	6/6	22/22	38/38	54/54	70/70	86/86	102/102	118/118
5	5/5	21/21	37/37	53/53	69/69	85/85	101/101	117/117
4	4/4	20/20	36/36	52/52	68/68	84/84	100/100	116/116
3	3/3	19/19	35/35	51/51	67/67	83/83	99/99	115/115
2	2/2	18/18	34/34	50/50	66/66	82/82	98/98	114/114
1	1/1	17/17	33/33	49/49	65/65	81/81	97/97	113/113
0	0/0	16/16	32/32	48/48	64/64	80/80	96/96	112/112

## Port indexing on the Brocade DCX backbone

**Table 100** shows the index and PID mapping for the Brocade DCX enterprise-class platform. This table provides the index/PID assignment for the maximum number of ports (used by the FC8-64 blade). If your blade does not have the maximum number of ports, use the lower sections of the table to determine the index and PID assignment.

The following is an example of **switchShow** output from a Brocade DCX shows the index and PID address. The output has been truncated.

```
DCX:admin> switchshow
Index Slot Port Address Media Speed State
=====
0     1     0     0a0040  --    N4    No_Module
1     1     1     0a0140  --    N4    No_Module
2     1     2     0a0240  --    N4    No_Module
(output truncated)
768   1     48    0a00c0  --    N4    No_Module
769   1     49    0a01c0  --    N4    No_Module
770   1     50    0a02c0  --    N4    No_Module
(output truncated)
783   1     61    0a0dc0  --    N4    No_Module
784   1     62    0a0ec0  --    N4    No_Module
783   1     63    0a0fc0  --    N4    No_Module
16    2     0     0a1040  --    N4    No_Module
17    2     1     0a1140  --    N4    No_Module
18    2     2     0a1240  --    N4    No_Module
(output truncated)
```

**TABLE 100** Default index/16-bit PID assignment with no port swap on a Brocade DCX backbone

Port (DCX)	Slot 1 Index/PID	Slot 2 Index/PID	Slot 3 Index/PID	Slot 4 Index/PID	Slot 9 Index/PID	Slot 10 Index/PID	Slot 11 Index/PID	Slot 12 Index/PID
63	783/0x0fc0	799/0x1fc0	815/0x2fc0	831/0x3fc0	847/0x4fc0	863/0x5fc0	879/0x6fc0	895/0x7fc0
62	782/0x0ec0	798/0x1ec0	814/0x2ec0	830/0x3ec0	846/0x4ec0	862/0x5ec0	878/0x6ec0	894/0x7ec0
61	781/0x0dc0	797/0x1dc0	813/0x2dc0	829/0x3dc0	845/0x4dc0	861/0x5dc0	877/0x6dc0	893/0x7dc0
60	780/0x0cc0	796/0x1cc0	812/0x2cc0	828/0x3cc0	844/0x4cc0	860/0x5cc0	876/0x6cc0	892/0x7cc0
59	779/0x0bc0	795/0x1bc0	811/0x2bc0	827/0x3bc0	843/0x4bc0	859/0x5bc0	875/0x6bc0	891/0x7bc0
58	778/0x0ac0	794/0x1ac0	810/0x2ac0	826/0x3ac0	842/0x4ac0	858/0x5ac0	874/0x6ac0	890/0x7ac0
57	777/0x09c0	793/0x19c0	809/0x29c0	825/0x39c0	841/0x49c0	857/0x59c0	873/0x69c0	889/0x79c0
56	776/0x08c0	792/0x18c0	808/0x28c0	824/0x38c0	840/0x48c0	856/0x58c0	872/0x68c0	888/0x78c0
55	775/0x07c0	791/0x17c0	807/0x27c0	823/0x37c0	839/0x47c0	855/0x57c0	871/0x67c0	887/0x77c0
54	774/0x06c0	790/0x16c0	806/0x26c0	822/0x36c0	838/0x46c0	854/0x56c0	870/0x66c0	886/0x76c0
53	773/0x05c0	789/0x15c0	805/0x25c0	821/0x35c0	837/0x45c0	853/0x55c0	869/0x65c0	885/0x75c0
52	772/0x04c0	788/0x14c0	804/0x24c0	820/0x34c0	836/0x44c0	852/0x54c0	868/0x64c0	884/0x74c0
51	771/0x03c0	787/0x13c0	803/0x23c0	819/0x33c0	835/0x43c0	851/0x53c0	867/0x63c0	883/0x73c0
50	770/0x02c0	786/0x12c0	802/0x22c0	818/0x32c0	834/0x42c0	850/0x52c0	866/0x62c0	882/0x72c0
49	769/0x01c0	785/0x11c0	801/0x21c0	817/0x31c0	833/0x41c0	849/0x51c0	865/0x61c0	881/0x71c0
48	768/0x00c0	784/0x10c0	800/0x20c0	816/0x30c0	832/0x40c0	848/0x50c0	864/0x60c0	880/0x70c0

## C Port indexing on the Brocade DCX backbone

**TABLE 100** Default index/16-bit PID assignment with no port swap on a Brocade DCX backbone (Continued)

Port (DCX)	Slot 1 Index/PID	Slot 2 Index/PID	Slot 3 Index/PID	Slot 4 Index/PID	Slot 9 Index/PID	Slot 10 Index/PID	Slot 11 Index/PID	Slot 12 Index/PID
47	271/0x87c0	287/0x97c0	303/0xa7c0	319/0xb7c0	335/0xc7c0	351/0xd7c0	367/0xe7c0	383/0xf7c0
46	270/0x86c0	286/0x96c0	302/0xa6c0	318/0xb6c0	334/0xc6c0	350/0xd6c0	366/0xe6c0	382/0xf6c0
45	269/0x85c0	285/0x95c0	301/0xa5c0	317/0xb5c0	333/0xc5c0	349/0xd5c0	365/0xe5c0	381/0xf5c0
44	268/0x84c0	284/0x94c0	300/0xa4c0	316/0xb4c0	332/0xc4c0	348/0xd4c0	364/0xe4c0	380/0xf4c0
43	267/0x83c0	283/0x93c0	299/0xa3c0	315/0xb3c0	331/0xc3c0	347/0xd3c0	363/0xe3c0	379/0xf3c0
42	266/0x82c0	282/0x92c0	298/0xa2c0	314/0xb2c0	330/0xc2c0	346/0xd2c0	362/0xe2c0	378/0xf2c0
41	265/0x81c0	281/0x91c0	297/0xa1c0	313/0xb1c0	329/0xc1c0	345/0xd1c0	361/0xe1c0	377/0xf1c0
40	264/0x80c0	280/0x90c0	296/0xa0c0	312/0xb0c0	328/0xc0c0	344/0xd0c0	360/0xe0c0	376/0xf0c0
39	263/0x8fc0	279/0x9fc0	295/0xafc0	311/0xbfc0	327/0xcfc0	343/0xdfc0	359/0xefc0	375/0xffc0
38	262/0x8ec0	278/0x9ec0	294/0xaec0	310/0xbec0	326/0xc6c0	342/0xd6c0	358/0x6ec0	374/0xf6c0
37	261/0x8dc0	277/0x9dc0	293/0xad0	309/0xbdc0	325/0xc5c0	341/0xddc0	357/0xedc0	373/0xfdc0
36	260/0x8cc0	276/0x9cc0	292/0xacc0	308/0xbcc0	324/0xc4c0	340/0xdcc0	356/0x6cc0	372/0xfcc0
35	259/0x8bc0	275/0x9bc0	291/0xabc0	307/0xbbc0	323/0xc3c0	339/0xd3c0	355/0x6bc0	371/0xfbc0
34	258/0x8ac0	274/0x9ac0	290/0xaac0	306/0xbac0	322/0xc2c0	338/0xd2c0	354/0x6ac0	370/0xfac0
33	257/0x89c0	273/0x99c0	289/0xa9c0	305/0xb9c0	321/0xc1c0	337/0xd1c0	353/0x69c0	369/0xf9c0
32	256/0x88c0	272/0x98c0	288/0xa8c0	304/0xb8c0	320/0xc0c0	336/0xd8c0	352/0x68c0	368/0xf8c0
31	143/0x8f40	159/0x9f40	175/0xaf40	191/0xbf40	207/0xcf40	223/0xdf40	239/0xef40	255/0xff40
30	142/0x8e40	158/0x9e40	174/0xae40	190/0xbe40	206/0xce40	222/0xde40	238/0xee40	254/0xfe40
29	141/0x8d40	157/0x9d40	173/0xad40	189/0xbd40	205/0xcd40	221/0xdd40	237/0xed40	253/0xfd40
28	140/0x8c40	156/0x9c40	172/0xac40	188/0xbc40	204/0xcc40	220/0xdc40	236/0xec40	252/0xfc40
27	139/0x8b40	155/0x9b40	171/0xab40	187/0xbb40	203/0xcb40	219/0xdb40	235/0xeb40	251/0xfb40
26	138/0x8a40	154/0x9a40	170/0xaa40	186/0xba40	202/0xca40	218/0xda40	234/0xea40	250/0xfa40
25	137/0x8940	153/0x9940	169/0xa940	185/0xb940	201/0xc940	217/0xd940	233/0xe940	249/0xf940
24	136/0x8840	152/0x9840	168/0xa840	184/0xb840	200/0xc840	216/0xd840	232/0xe840	248/0xf840
23	135/0x8740	151/0x9740	167/0xa740	183/0xb740	199/0xc740	215/0xd740	231/0xe740	247/0xf740
22	134/0x8640	150/0x9640	166/0xa640	182/0xb640	198/0xc640	214/0xd640	230/0xe640	246/0xf640
21	133/0x8540	149/0x9540	165/0xa540	181/0xb540	197/0xc540	213/0xd540	229/0xe540	245/0xf540
20	132/0x8440	148/0x9440	164/0xa440	180/0xb440	196/0xc440	212/0xd440	228/0xe440	244/0xf440
19	131/0x8340	147/0x9340	163/0xa340	179/0xb340	195/0xc340	211/0xd340	227/0xe340	243/0xf340
18	130/0x8240	146/0x9240	162/0xa240	178/0xb240	194/0xc240	210/0xd240	226/0xe240	242/0xf240
17	129/0x8140	145/0x9140	161/0xa140	177/0xb140	193/0xc140	209/0xd140	225/0xe140	241/0xf140
16	128/0x8040	144/0x9040	160/0xa040	176/0xb040	192/0xc040	208/0xd040	224/0xe040	240/0xf040
15	15/0x0f40	31/0x1f40	47/0x2e40	63/0x3f40	79/0x4f40	95/0x5f40	111/0x6f40	127/0x7f40
14	14/0x0e40	30/0x1e40	46/0x2e40	62/0x3e40	78/0x4e40	94/0x5e40	110/0x6e40	126/0x7e40
13	13/0x0d40	29/0x1d40	45/0x2d40	61/0x3d40	77/0x4d40	93/0x5d40	109/0x6d40	125/0x7d40

TABLE 100 Default index/16-bit PID assignment with no port swap on a Brocade DCX backbone (Continued)

Port (DCX)	Slot 1 Index/PID	Slot 2 Index/PID	Slot 3 Index/PID	Slot 4 Index/PID	Slot 9 Index/PID	Slot 10 Index/PID	Slot 11 Index/PID	Slot 12 Index/PID
12	12/0x0c40	28/0x1c40	44/0x2c40	60/0x3c40	76/0x4c40	92/0x5c40	108/0x6c40	124/0x7c40
11	11/0x0b40	27/0x1b40	43/0x2b40	59/0x3b40	75/0x4b40	91/0x5b40	107/0x6b40	123/0x7b40
10	10/0x0a40	26/0x1a40	42/0x2a40	58/0x3a40	74/0x4a40	90/0x5a40	106/0x6a40	122/0x7a40
9	9/0x0940	25/0x1940	41/0x2940	57/0x3940	73/0x4940	89/0x5940	105/0x6940	121/0x7940
8	8/0x0840	24/0x1840	40/0x2840	56/0x3840	72/0x4840	88/0x5840	104/0x6840	120/0x7840
7	7/0x0740	23/0x1740	39/0x2740	55/0x3740	71/0x4740	87/0x5740	103/0x6740	119/0x7740
6	6/0x0640	22/0x1640	38/0x2640	54/0x3640	70/0x4640	86/0x5640	102/0x6640	118/0x7640
5	5/0x0540	21/0x1540	37/0x2540	53/0x3540	69/0x4540	85/0x5540	101/0x6540	117/0x7540
4	4/0x0440	20/0x1440	36/0x2440	52/0x3440	68/0x4440	84/0x5440	100/0x6440	116/0x7440
3	3/0x0340	19/0x1340	35/0x2340	51/0x3340	67/0x4340	83/0x5340	99/0x6340	115/0x7340
2	2/0x0240	18/0x1240	34/0x2240	50/0x3240	66/0x4240	82/0x5240	98/0x6240	114/0x7240
1	1/0x0140	17/0x1140	33/0x2140	49/0x3140	65/0x4140	81/0x5140	97/0x6140	113/0x7140
0	0/0x0040	16/0x1040	32/0x2040	48/0x3040	64/0x4040	80/0x5040	96/0x6040	112/0x7040

## Port indexing on the Brocade DCX-4S backbone

The Brocade DCX-4S does not need a mapping of ports because it is a one-to-one mapping. The order is sequential starting at slot 1 port 0 all the way through slot 8 port 255 for the FC8-64 blade. There are no shared areas on the Brocade DCX-4S.

Table 101 shows the PID assignment for each port. For those who are not familiar with the hexadecimal value, the decimal value of the port is listed first followed by the PID assignment in hexadecimal.

The following example **switchShow** output is from a Brocade DCX-4S. It shows the index and PID addressing. The output has been truncated.

```
DCX-4S:admin> switchshow
Index Slot Port Address Media Speed State
=====
   0   1   0   0a0000  --   N4   No_Module
   1   1   1   0a0100  --   N4   No_Module
   2   1   2   0a0200  --   N4   No_Module
(output truncated)
  48   1  48   0a3000  --   N4   No_Module
  49   1  49   0a3100  --   N4   No_Module
  50   1  50   0a3200  --   N4   No_Module
(output truncated)
  61   1  61   0a3d00  --   N4   No_Module
  62   1  62   0a3e00  --   N4   No_Module
  63   1  63   0a3f00  --   N4   No_Module
  64   2   0   0a4000  --   N4   No_Module
  65   2   1   0a4100  --   N4   No_Module
  66   2   2   0a4200  --   N4   No_Module
(output truncated)
```

**TABLE 101** Default index/16-bit PID assignment with no port swap for the Brocade DCX-4S

Port on blade	Slot 1 Index/PID	Slot 2 Index/PID	Slot 7 Index/PID	Slot 8 Index/PID
63	63/0x3f00	127/0x7f00	191/0xbf00	255/0xff00
62	62/0x3e00	126/0x7e00	190/0xbe00	254/0xfe00
61	61/0x3d00	125/0x7d00	189/0xbd00	253/0xfd00
60	60/0x3c00	124/0x7c00	188/0xbc00	252/0xfc00
59	59/0x3b00	123/0x7b00	187/0xbb00	251/0xfb00
58	58/0x3a00	122/0x7a00	186/0xba00	250/0xfa00
57	57/0x3900	121/0x7900	185/0xb900	249/0xf900
56	56/0x3800	120/0x7800	184/0xb800	248/0xf800
55	55/0x3700	119/0x7700	183/0xb700	247/0xf700
54	54/0x3600	118/0x7600	182/0xb600	246/0xf600
53	53/0x3500	117/0x7500	181/0xb500	245/0xf500
52	52/0x3400	116/0x7400	180/0xb400	244/0xf400
51	51/0x3300	115/0x7300	179/0xb300	243/0xf300
50	50/0x3200	114/0x7200	178/0xb200	242/0xf200
49	49/0x3100	113/0x7100	177/0xb100	241/0xf100
48	48/0x3000	112/0x7000	176/0xb000	240/0xf000
47	47/0x2f00	111/0x6f00	175/0xaf00	239/0xef00
46	46/0x2e00	110/0x6e00	174/0xae00	238/0xee00
45	45/0x2d00	109/0x6d00	173/0xad00	237/0xed00
44	44/0x2c00	108/0x6c00	172/0xac00	236/0xec00
43	43/0x2b00	107/0x6b00	171/0xab00	235/0xeb00
42	42/0x2a00	106/0x6a00	170/0xaa00	234/0xea00
41	41/0x2900	105/0x6900	169/0xa900	233/0xe900
40	40/0x2800	104/0x6800	168/0xa800	232/0xe800
39	39/0x2700	103/0x6700	167/0xa700	231/0xe700
38	38/0x2600	102/0x6600	166/0xa600	230/0xe600
37	37/0x2500	101/0x6500	165/0xa500	229/0xe500
36	36/0x2400	100/0x6400	164/0xa400	228/0xe400
35	35/0x2300	99/0x6300	163/0xa300	227/0xe300
34	34/0x2200	98/0x6200	162/0xa200	226/0xe200
33	33/0x2100	97/0x6100	161/0xa100	225/0xe100
32	32/0x2000	96/0x6000	160/0xa000	224/0xe000
31	31/0x1f00	95/0x5f00	159/0x9f00	223/0xdf00
30	30/0x1e00	94/0x5e00	158/0x9e00	222/0xde00
29	29/0x1d00	93/0x5d00	157/0x9d00	221/0xdd00

**TABLE 101** Default index/16-bit PID assignment with no port swap for the Brocade DCX-4S (Continued)

Port on blade	Slot 1 Index/PID	Slot 2 Index/PID	Slot 7 Index/PID	Slot 8 Index/PID
28	28/0x1c00	92/0x5c00	156/0x9c00	220/0xdc00
27	27/0x1b00	91/0x5b00	155/0x9b00	219/0xdb00
26	26/0x1a00	90/0x5a00	154/0x9a00	218/0xda00
25	25/0x1900	89/0x5900	153/0x9900	217/0xd900
24	24/0x1800	88/0x5800	152/0x9800	216/0xd800
23	23/0x1700	87/0x5700	151/0x9700	215/0xd700
22	22/0x1600	86/0x5600	150/0x9600	214/0xd600
21	21/0x1500	85/0x5500	149/0x9500	213/0xd500
20	20/0x1400	84/0x5400	148/0x9400	212/0xd400
19	19/0x1300	83/0x5300	147/0x9300	211/0xd300
18	18/0x1200	82/0x5200	146/0x9200	210/0xd200
17	17/0x1100	81/0x5100	145/0x9100	209/0xd100
16	16/0x1000	80/0x5000	144/0x9000	208/0xd000
15	15/0x0f00	79/0x4f00	143/0x8f00	207/0xcf00
14	14/0x0e00	78/0x4e00	142/0x8e00	206/0xce00
13	13/0x0d00	77/0x4d00	141/0x8d00	205/0xcd00
12	12/0x0c00	76/0x4c00	140/0x8c00	204/0xcc00
11	11/0x0b00	75/0x4b00	139/0x8b00	203/0xcb00
10	10/0x0a00	74/0x4a00	138/0x8a00	202/0xca00
9	9/0x900	73/0x4900	137/0x8900	201/0xc900
8	8/0x800	72/0x4800	136/0x8800	200/0xc800
7	7/0x700	71/0x4700	135/0x8700	199/0xc700
6	6/0x600	70/0x4600	134/0x8600	198/0xc600
5	5/0x0500	69/0x4500	133/0x8500	197/0xc500
4	4/0x0400	68/0x4400	132/0x8400	196/0xc400
3	3/0x0300	67/0x4300	131/0x8300	195/0xc300
2	2/0x0200	66/0x4200	130/0x8200	194/0xc200
1	1/0x0100	65/0x4100	129/0x8100	193/0xc100
0	0/0x0000	64/0x4000	128/0x8000	192/0xc000

## C Port indexing on the Brocade DCX-4S backbone



# FIPS Support

---

## In this appendix

- [FIPS overview](#) ..... 521
- [Zeroization functions](#) ..... 521
- [FIPS mode configuration](#) ..... 523
- [Preparing the switch for FIPS](#) ..... 527

## FIPS overview

Federal information processing standards (FIPS) specify the security standards to be satisfied by a cryptographic module utilized in Fabric OS v6.0.0 and later to protect sensitive information in the switch. As part of FIPS 140-2 level 2 compliance passwords, shared secrets, and the private keys used in SSL, TLS, and system login need to be cleared out or *zeroized*. Power-up self tests are executed when the switch is powered on to check for the consistency of the algorithms implemented in the switch. Known-answer-tests (KATs) are used to exercise various features of the algorithm and their results are displayed on the console for your reference. Conditional tests are performed whenever an RSA key pair is generated. These tests verify the randomness of the deterministic and non-deterministic random number generator (DRNG and non-DRNG). They also verify the consistency of RSA keys with regard to signing and verification and encryption and decryption.

---

### ATTENTION

When FIPS mode is enabled, this is a chassis-wide setting and affects all logical switches.

---

## Zeroization functions

Explicit zeroization can be done at the discretion of the security administrator. These functions clear the passwords and the shared secrets. [Table 102](#) lists the various keys used in the system that will be zeroized in a FIPS-compliant Fabric OS module.

**TABLE 102** Zeroization behavior

Keys	Zeroization CLI	Description
DH private keys	No CLI required	Keys will be zeroized within code before they are released from memory.
FCAP private key	pkiRemove	The <b>pkiCreate</b> command creates the keys, and 'pkiremove' removes/zeroizes the keys.

**TABLE 102** Zeroization behavior (Continued)

Keys	Zeroization CLI	Description
FCSP Challenge Handshake Authentication Protocol (CHAP) Secret	secAuthSecret --remove <i>value</i>   --all	The <b>secAuthSecret --remove <i>value</i></b> is used to remove the specified keys from the database. When the <b>secAuthSecret</b> command is used with --remove --all option then the entire key database is deleted.
Passwords	passwdDefault fipscfg --zeroize	This will remove user-defined accounts in addition to default passwords for the root, admin, and user default accounts. However only root has permissions for this command. So securityadmin and admin roles need to use <b>fipsCfg --zeroize</b> , which in addition to removing user accounts and resetting passwords, also does the complete zeroization of the system.
RADIUS secret	aaaConfig --remove	The <b>aaaConfig --remove</b> zeroizes the secret and deletes a configured server.
RNG seed key	No CLI required	/dev/urandom is used as the initial source of seed for RNG. RNG seed key is zeroized on every random number generation.
SSH RSA private key	sshutil delprivkey	Key-based SSH authentication is not used for SSH sessions.
SSH RSA public key	sshutil delpubkeys	Key-based SSH authentication is not used for SSH sessions.
SSH session key	No CLI required	This is generated for each SSH session that is established to and from the host. It automatically zeroizes on session termination.
Third-party keys	secCertUtil delete -fcapall	Used to zeroize third-party keys.
TLS authentication key	No CLI required	Automatically zeroized on session termination.
TLS pre-master secret	No CLI required	Automatically zeroized on session termination.
TLS private keys	secCertUtil delkey -all	The command <b>secCertUtil delkey -all</b> is used to zeroize these keys.
TLS session key	No CLI required	Automatically zeroized on session termination.

## Power-up self tests

The power-up self tests (POST) are invoked by powering on the switch in FIPS mode and do not require any operator intervention. These power-up self tests perform power-on self-tests. If any KATs fail, the switch goes into a FIPS Error state which reboots the system to start the tests again. If the switch continues to fail the FIPS POSTs, you will need to boot into single-user mode and perform a recovery procedure to reset the switch. For more information on this procedure, refer to the *Fabric OS Troubleshooting and Diagnostics Guide*.

## Conditional tests

These tests are for the random number generators and are executed to verify the randomness of the random number generator. The conditional tests are executed each time prior to using the random number provided by the random number generator.

The results of all self-tests, for both power-up and conditional, are recorded in the system log or are output to the local console. This includes logging both passing and failing results. Refer to the *Fabric OS Troubleshooting and Diagnostics Guide* for instructions on how to recover if your system cannot get out of the conditional test mode.

## FIPS mode configuration

By default, the switch comes up in non-FIPS mode. You can run the `fipsCfg --enable fips` command to enable FIPS mode, but you need to configure the switch first. Self-tests mode must be enabled before FIPS mode can be enabled. A set of prerequisites as mentioned in the table below must be satisfied for the system to enter FIPS mode. To be FIPS-compliant, the switch must be rebooted. KATs are run on the reboot. If the KATs are successful, the switch enters FIPS mode. If KATs fail, then the switch reboots until the KATs succeed. If the switch cannot enter FIPS mode and continues to reboot, you must access the switch in single-user mode to break the reboot cycle. For more information on how to fix this issue, refer to the *Fabric OS Troubleshooting and Diagnostics Guide*.

Only FIPS-compliant algorithms are run at this stage. [Table 103](#) lists the Fabric OS feature and their behavior in FIPS and non-FIPS mode.

**TABLE 103 FIPS mode restrictions**

Features	FIPS mode	Non-FIPS mode
Configupload/ download/ supportsave/ firmwaredownload	SCP only	FTP and SCP
DH-CHAP/FCAP hashing algorithms	SHA-1	MD5 and SHA-1
HTTP/HTTPS access	HTTPS only	HTTP and HTTPS
HTTPS protocol/algorithms	TLS/AES128 cipher suite	TLS/AES128 cipher suite (SSL will no longer be supported)
IPsec	For FCIP IPsec the DH group 1 is FIPS-compliant and is not blocked. Usage of AES-XCBC, MD5 and DH group 0 and 1 are blocked. For IPsec (Ethernet), only MD5 is blocked in FIPS mode.	No restrictions
Radius auth protocols	PEAP-MSCHAPv2	CHAP, PAP, PEAP-MSCHAPv2
Root account	Disabled	Enabled
RPC/secure RPC access	Secure RPC only	RPC and secure RPC
Secure RPC protocols	TLS - AES128 cipher suite	SSL and TLS – all cipher suites
Signed firmware	Mandatory firmware signature validation.	Optional firmware signature validation
SNMP	Read-only operations	Read and write operations
SSH algorithms	HMAC-SHA1 (mac) 3DES-CBC, AES128-CBC, AES192-CBC, AES256-CBC (cipher suites)	No restrictions
Telnet/SSH access	Only SSH	Telnet and SSH

## LDAP in FIPS mode

You can configure your Microsoft Active Directory server to use LDAP while in FIPS mode. There is no option provided on the switch to configure TLS ciphers for LDAP in FIPS mode. However, the LDAP client checks if FIPS mode is set on the switch and uses the FIPS-compliant TLS ciphers for LDAP. If the FIPS mode is not set and the Microsoft Active Directory server is configured for FIPS ciphers, it uses FIPS-compliant ciphers.

Table 104 lists the differences between FIPS and non-FIPS modes of operation.

**TABLE 104 FIPS and non-FIPS modes of operation**

FIPS mode	non-FIPS mode
<ul style="list-style-type: none"> <li>The CA who issued the Microsoft Active Directory server certificate must be installed on the switch.</li> </ul>	<ul style="list-style-type: none"> <li>There is no mandatory CA certificate installation on the switch.</li> </ul>
<ul style="list-style-type: none"> <li>Configure FIPS compliant TLS ciphers [TDES-168, SHA1 and RSA-1024] on Microsoft Active Directory server. The host needs a reboot for the changes to take effect.</li> </ul>	<ul style="list-style-type: none"> <li>On the Microsoft Active Directory server, there is no configuration of the FIPS compliant TLS ciphers.</li> </ul>
<ul style="list-style-type: none"> <li>The switch uses FIPS-compliant ciphers regardless of Microsoft Active Directory server configuration. If the Microsoft Active Directory server is not configured for FIPS ciphers, authentication will still succeed.</li> </ul>	<ul style="list-style-type: none"> <li>The Microsoft Active Directory server certificate is validated if the CA certificate is found on the switch</li> </ul>
<ul style="list-style-type: none"> <li>The Microsoft Active Directory server certificate is validated by the LDAP client. If the CA certificate is not present on the switch then user authentication will fail.</li> </ul>	<ul style="list-style-type: none"> <li>If Microsoft Active Directory server is configured for FIPS ciphers and the switch is in non-FIPS mode then user authentication will succeed.</li> </ul>

### Setting up LDAP for FIPS mode

1. Set the switch authentication mode and add your LDAP server by using the commands in the example below. Provide the Fully Qualified Domain Name (FQDN) of the Active Directory server for the hostname parameter while configuring LDAP.

#### Example of setting up LDAP for FIPS mode

```
switch:admin> aaaconfig --add GEOFF5.ADLLDAP.LOCAL -conf ldap -d adldap.local
-p 389 -t 3
switch:admin> aaaconfig --authspec "ldap;local"
switch:admin> aaaconfig -show
RADIUS CONFIGURATIONS
=====
RADIUS configuration does not exist.

LDAP CONFIGURATIONS
=====

Position          : 1
Server            : GEOFF5.ADLLDAP.LOCAL
Port              : 389
Domain            : adldap.local
Timeout(s)       : 3

Primary AAA Service: LDAP
Secondary AAA Service: Switch database
```

2. Configure the DNS on the switch by using the **dnsConfig** command.

#### Example of setting the DNS

```
switch:admin> dnsconfig

Enter option
1 Display Domain Name Service (DNS) configuration
2 Set DNS configuration
3 Remove DNS configuration
4 Quit
Select an item: (1..4) [4] 2

Enter Domain Name: [] domain.com
Enter Name Server IP address in dot notation: [] 123.123.123.123
Enter Name Server IP address in dot notation: [] 123.123.123.124
DNS parameters saved successfully

Enter option
1 Display Domain Name Service (DNS) configuration
2 Set DNS configuration
3 Remove DNS configuration
4 Quit
Select an item: (1..4) [4] 4
```

Specify the DNS IP address using either IPv4 or IPv6. This is needed for the switch to resolve the domain name to the IP address because LDAP initiates a TCP session to connect to your Microsoft Active Directory server. A Fully Qualified Domain Name (FQDN) is needed to validate the server identity as mentioned in the common name of the server certificate.

3. Set up LDAP according to the instructions in [“LDAP configuration and Microsoft Active Directory”](#) on page 111 in [Chapter 5, “Managing User Accounts”](#).

- *Additional Microsoft Active Directory settings*

- a. Set the following SCHANNEL settings listed in [Table 105](#) to **allow**.

To support FIPS-compliant TLS cipher suites on Microsoft’s Active Directory server, allow the SCHANNEL settings listed in [Table 105](#). Refer to [www.microsoft.com](http://www.microsoft.com) for instructions on how to allow the SCHANNEL settings for the ciphers, hashes, key exchange and the TLS protocol.

**TABLE 105** Active Directory keys to modify

Key	Sub-key
Ciphers	3DES
Hashes	SHA1
Key exchange algorithm	PKCS
Protocols	TLSv1.0

- b. Enable FIPS algorithm policy on the Microsoft Active Directory. Refer to [www.microsoft.com](http://www.microsoft.com) for instructions.

## LDAP certificates for FIPS mode

To utilize the LDAP services for FIPS between the switch and the host, you must generate a CSR on the Active Directory server and import and export the CA certificates. To support server certificate validation, it is essential to have the CA certificate installed on the switch and Active Directory server. Use the **secCertUtil** to import the CA certificate to the switch. This will prompt for the remote IP and login credentials to retrieve the CA certificate. The CA certificate should be in any of the standard certificate formats, “.cer”, “.crt” or “.pem”.

For storing and obtaining CA certificates, follow the instructions earlier in this section. LDAP CA certificate file names should not contain spaces while using the **secCertUtil** command to import and export the certificate.

### *Importing an LDAP switch certificate*

This option imports the LDAP CA certificate from the remote host to the switch.

1. Connect to the switch and log in as admin.
2. Enter the **secCertUtil import -ldapcert** command.

#### **Example of importing an LDAP certificate**

```
switch:admin> seccertutil import -ldapcert
Select protocol [ftp or scp]: scp
Enter IP address: 192.168.38.206
Enter remote directory: /users/aUser/certs
Enter certificate name (must have ".crt" or ".cer" ".pem" suffix):
LDAPTestCa.cer
Enter Login Name: aUser
Password: <hidden>
Success: imported certificate [LDAPTestCa.cer].
```

### *Exporting an LDAP switch certificate*

This option exports the LDAP CA certificate from the switch to the remote host.

1. Connect to the switch and log in as admin.
2. Enter the **secCertUtil export -ldapcert** command.

#### **Example of exporting an LDAP CA certificate**

```
switch:admin> seccertutil export -ldapcert
Select protocol [ftp or scp]: scp
Enter IP address: 192.168.38.206
Enter remote directory: /users/aUser/certs
Enter Login Name: aUser
Enter LDAP certificate name (must have ".pem" \ suffix):LDAPTestCa.cer
Password: <hidden>
Success: exported LDAP certificate
```

### *Deleting an LDAP switch certificate*

This option deletes the LDAP CA certificate from the switch.

1. Connect to the switch and log in as admin.
2. Enter the **secCertUtil show -ldapcacert** command to determine the name of the LDAP certificate file.
3. Enter the **secCertUtil delete -ldapcacert <file\_name>** command, where the <file\_name> is the name of the LDAP certificate on the switch.

#### **Example of deleting an LDAP CA certificate**

```
switch:admin> seccertutil delete -ldapcacert LDAPTestCa.pem  
WARNING!!!
```

```
About to delete certificate: LDAPTestCa.cer  
ARE YOU SURE (yes, y, no, n): [no] y  
Deleted LDAP certificate successfully
```

## Preparing the switch for FIPS

The following functions are blocked in FIPS mode. Therefore, it is important to prepare the switch by disabling these functions prior to enabling FIPS:

- The root account and all root-only functions are not available.
- HTTP, Telnet, RPC, SNMP protocols need to be disabled. Once these are blocked, you cannot use these protocols to read or write data from and to the switch.
- The **configDownload** and **firmwareDownload** commands using an FTP server are blocked.

See [Table 103](#) on page 523 for a complete list of restrictions between FIPS and non-FIPS modes.

---

#### **ATTENTION**

Only roles with SecurityAdmin and Admin can enable FIPS mode.

---

### **Overview of steps**

1. *Optional:* Configure RADIUS server or LDAP server.
2. *Optional:* Configure authentication protocols.
3. For LDAP only: Install SSL certificate on Microsoft Active Directory server and CA certificate on the switch for using LDAP authentication.
4. Block Telnet, HTTP, and RPC.
5. Disable BootProm access.
6. Configure the switch for signed firmware.
7. Disable root access.
8. Enable FIPS.

## Enabling FIPS mode

1. Log in to the switch using an account assigned the admin or securityAdmin role.
2. *Optional:* Select the appropriate method based on your needs:
  - If the switch is set for *RADIUS*, modify each server to use only *peap-mschapv2* as the authentication protocol using the **aaaConfig --change** or **aaaConfig --remove** command.
  - If the switch is set for *LDAP*, refer to the instructions in [“Setting up LDAP for FIPS mode”](#) on page 524.
3. *Optional:* Set the authentication protocols.
  - a. Type the following command to set the hash type for MD5 which is used in authentication protocols DHCHAP and FCAP:

```
authutil --set -h sha1
```

- b. Set the DH group to 1 or 2 or 3 or 4 using **authUtil --set -g <n>**, where the DH group is represented by <n>.
4. Install the LDAP CA certificate on the switch and Microsoft Active Directory server. Refer to the instructions [“LDAP certificates for FIPS mode”](#) on page 526.
5. Block Telnet, HTTP, and RPC using the **ipfilter** policy command.

You will need to create an IPFilter policy for each protocol.

- a. Create an IP filter rule for each protocol, see [“Creating an IP Filter policy”](#) on page 153.
- b. Add a rule to the IP filter policy, see [“Adding a rule to an IP Filter policy”](#) on page 157. You can use the following modifications to the rule:

```
ipfilter --addrule <policyname> -rule <rule_number> -sip <source_IP> -dp <dest_port> -proto <protocol> -act <deny>
```

- **-sip** option can be given as *any*
  - **-dp** option for the port numbers for Telnet, HTTP, and RPC are 23, 80, and 898 respectively
  - **-proto** option should be set to **tcp**
- c. Activate the IP filter policy, see [“Activating an IP Filter policy”](#) on page 154.
  - d. Save the IP filter policy, see [“Saving an IP Filter policy”](#) on page 154.

### Example

```
ipfilter --createrule http_block_v4 --type ipv4
ipfilter --addrule http_block_v4 -rule 2 -sip any -dp 80 -proto tcp -act deny
ipfilter --activate http_block_v4
ipfilter --save http_block_v4
```

6. Type the following command to block access to the boot PROM:

```
fipscfg --disable bootprom
```

Block boot PROM access before disabling root account.

7. Enable signed firmware by typing the **configure** command and respond to the prompts as follows:

System services	No
cfgload attributes	Yes



```
Enforce secure config Upload/Download  Press enter to accept default.
Enforce firmware signature validation   Yes
```

**Example**

```
switch:admin> configure
Not all options will be available on an enabled switch.
To disable the switch, use the "switchDisable" command.
Configure...
System services (yes, y, no, n): [no]
...
cfgload attributes (yes, y, no, n): [no] yes
Enforce secure config Upload/Download (yes, y, no, n): [no]
Enforce firmware signature validation (yes, y, no, n): [no] yes
```

8. Type the following command to block access to root:

```
userconfig --change root -e no
```

By disabling the root account, RADIUS and LDAP users with root roles are also blocked in FIPS mode.

9. Verify your switch is FIPS ready:

```
fipscfg --verify fips
```

10. Type the command **fipsCfg --enable fips**.

11. Reboot the switch or if a director, reboot both CPs.

**Disabling FIPS mode**

1. Log in to the switch using an account assigned the admin or securityAdmin role.

2. Type the command **fipsCfg --disable fips**.

3. Reboot the switch.

4. Enable the root account by following the bootprom:

```
userconfig --change root -e yes
```

5. Enable access to the bootprom:

```
fipscfg --enable bootprom
```

6. *Optional:* Use the **configure** command to set switch to use non-signed firmware.

By keeping the switch set to use signed firmware, all firmware downloaded to the switch will have to be signed with a key. For more information, see [Chapter 9, "Installing and Maintaining Firmware"](#).

7. Disable selftests by typing the following command:

```
fipscfg --disable selftests
```

8. Disable IPFilter policies that were created to enable FIPS.

9. *Optional:* Configure RADIUS server authentication protocol.

10. Reboot the switch.

## D Preparing the switch for FIPS

### Zeroizing for FIPS

1. Log in to the switch using an account assigned the admin or securityAdmin role.
2. Type the command **fipsCfg --zeroize**.
3. Reboot the switch.

### Displaying FIPS configuration

1. Log in to the switch using an account assigned the admin or securityAdmin role.
2. Type the command **fipsCfg --showall**.

# Hexadecimal

---

## Hexadecimal overview

Hexadecimal, or simply hex, is a numeral system with a base of 16, usually written using unique symbols 0–9 and A–F, or a–f. Its primary purpose is to represent the binary code that computers interpret in a format easier for humans to read. It acts as a form of shorthand, in which one hexadecimal digit stands in place of four binary bits. For example, the decimal numeral 79, with the binary representation of 01001111, is 4F (or 4f) in hexadecimal (4 = 0100, F = 1111).

Hexadecimal numbers can have either an *Ox* prefix or an *h* suffix. The address 0xFFFFFA is the same address as FFFFFAh.

This type of address is called a hex triplet. Fibre Channel uses hexadecimal notation in hex triplets to specify well-known addresses and port IDs.

### Example conversion of the hexadecimal triplet 0x616000

Notice the PID in the `nsShow` output is in hexadecimal.

```
switch:admin> nsshow
{
  Type Pid      COS      PortName      NodeName      TTL(sec)
  N      610600;    2,3;10:00:00:00:c9:29:b3:84;20:00:00:00:c9:29:b3:84; na
    FC4s: FCP
    NodeSymb: [36] "Emulex LP9002 FV3.90A7 DV5-5.10A10 "
    Fabric Port Name: 20:08:00:05:1e:01:23:e0
    Permanent Port Name: 10:00:00:00:c9:29:b3:84
    Port Index: 6
    Share Area: No
    Device Shared in Other AD: No
    Redirect: No
  The Local Name Server has 1 entry }
```

1. Separate the triplets: 61 06 00
  2. Convert each hexadecimal value to a decimal representation:
    - 61 = Domain ID = 97
    - 06 = Area (port number) = 06
    - 00 = Port (ALPA) = 0 (not used in this instance, but is used in loop, shared areas in PID assignments on blades, NPIV, and Access Gateway devices)
- Result: hexadecimal triplet 610600 = decimal triplet 97,06,00

**TABLE 106** Decimal to hexadecimal conversion table

Decimal	01	02	03	04	05	06	07	08	09	10
Hex	01	02	03	04	05	06	07	08	09	0a
Decimal	11	12	13	14	15	16	17	18	19	20
Hex	0b	0c	0d	0e	0f	10	11	12	13	14
Decimal	21	22	23	24	25	26	27	28	29	30
Hex	15	16	17	18	19	1a	1b	1c	1d	1e
Decimal	31	32	33	34	35	36	37	38	39	40
Hex	1f	20	21	22	23	24	25	26	27	28
Decimal	41	42	43	44	45	46	47	48	49	50
Hex	29	2a	2b	2c	2d	2e	2f	30	31	32
Decimal	51	52	53	54	55	56	57	58	59	60
Hex	33	34	35	36	37	38	39	3a	3b	3c
Decimal	61	62	63	64	65	66	67	68	69	70
Hex	3d	3e	3f	40	41	42	43	44	45	46
Decimal	71	72	73	74	75	76	77	78	79	80
Hex	47	48	49	4a	4b	4c	4d	4e	4f	50
Decimal	81	82	83	84	85	86	87	88	89	90
Hex	51	52	53	54	55	56	57	58	59	5a
Decimal	91	92	93	94	95	96	97	98	99	100
Hex	5b	5c	5d	5e	5f	60	61	62	63	64
Decimal	101	102	103	104	105	106	107	108	109	110
Hex	65	66	67	68	69	6a	6b	6c	6d	6e
Decimal	111	112	113	114	115	116	117	118	119	120
Hex	6f	70	71	72	73	74	75	76	77	78
Decimal	121	122	123	124	125	126	127	128	129	130
Hex	79	7a	7b	7c	7d	7e	7f	80	81	82
Decimal	131	132	133	134	135	136	137	138	139	140
Hex	83	84	85	86	87	88	89	8a	8b	8c
Decimal	141	142	143	144	145	146	147	148	149	150
Hex	8d	8e	8f	90	91	92	93	94	95	96
Decimal	151	152	153	154	155	156	157	158	159	160
Hex	97	98	99	9a	9b	9c	9d	9e	9f	a0
Decimal	161	162	163	164	165	166	167	168	169	170
Hex	a1	a2	a3	a4	a5	a6	a7	a8	a9	aa
Decimal	171	172	173	174	175	176	177	178	179	180
Hex	ab	ac	ad	ae	af	b0	b1	b2	b3	b4

**TABLE 106** Decimal to hexadecimal conversion table (Continued)

Decimal	181	182	183	184	185	186	187	188	189	190
Hex	b5	b6	b7	b8	b9	ba	bb	bc	bd	be
Decimal	191	192	193	194	195	196	197	198	199	200
Hex	bf	c0	c1	c2	c3	c4	c5	c6	c7	c8
Decimal	201	202	203	204	205	206	207	208	209	210
Hex	c9	ca	cb	cc	cd	ce	cf	d0	d1	d2
Decimal	211	212	213	214	215	216	217	218	219	220
Hex	d3	d4	d5	d6	d7	d8	d9	da	db	dc
Decimal	221	222	223	224	225	226	227	228	229	230
Hex	dd	de	df	e0	e1	e2	e3	e4	e5	e6
Decimal	231	232	233	234	235	236	237	238	239	240
Hex	e7	e8	e9	ea	eb	ec	ed	ef	ee	f0
Decimal	241	242	243	244	245	246	247	248	249	250
Hex	f1	f2	f3	f4	f5	f6	f7	f8	f9	fa
Decimal	251	252	253	254	255					
Hex	fb	fc	fd	fe	ff					

# E Hexadecimal overview

# Index

---

## Numerics

239 domain ID mode, 301

## A

AAA service requests, 99

access

browser support, 122

changing account parameters, 89

CP blade, 105

creating accounts, 88

deleting accounts, 89

IP address changes, 17

log in fails, 17

NTP, 28

password, changing, 19

remote access policies, 108

secure, HTTPS, 122

secure, SSL, 122

SNMP ACL, 127

accessing switches and fabrics, 131

account ID, 18

accounts

changing parameters, 89

creating, 88

deleting, 89

displaying information, 88

lockout policy, 93

lockout policy, duration, 94

lockout policy, threshold, 94

managing passwords, 89

password rules, 89

user-defined, 88

activating

Admin Domains, 348

POD, 379

ports on demand, 377

TI zones, 285

ADO, 338

AD255, 339

Adaptive Networking, 401

adding

a new switch or fabric to a zone, 261

Admin Domain members, 349

alias members, 247

end-to-end monitors, 385

members to a zone configuration, 254

ports to logical switches, 229

switches to a zone, 261

zone members, 249

addressing mode

10-bit, 36

256-area, 37

core PID, 36

fixed, 36, 292

## Admin Domains

- about, 335
- access levels, 338
- activating, 348
- ADO, 338
- AD255, 339
- adding members, 349
- ADList, 104
- assigning users to, 346
- configupload, download, 362
- configuration, displaying, 358
- creating, 345
- deactivating, 349
- defined AD configuration, 344
- deleting, 351, 352
- effective AD configuration, 344
- homeAD, 104, 340
- implementing, 344
- interaction with Fabric OS features, 359
- logging in to, 340
- LSAN zones, 362
- member types, 341
- numbering, 335
- physical fabric administrator, 338
- removing from user accounts, 348
- removing members, 350
- renaming, 350
- requirements, 337
- switch WWN, 342
- switching context, 358
- system-defined, 338
- transaction model, 344
- user-defined, 338
- using, 356
- validating members, 356
- zone database, 360

## alias

- adding members, 247
- creating, 246
- deleting, 248
- removing members, 247

## Alias server, 4

## AP route policy, 75

## assigning

- static routes, 77

## assigning users to Admin Domains, 346

## AUTH policy, 144

## authenticating users, 84

## authentication

- configuring, 99
- local, 115

## auto-leveling, FR4-18i blade, 198, 205

## B

### backbone fabric ID, 466

### backbone-to-edge routing, 461, 466

### backing up a configuration, 178

### base switches

- about, 216
- creating, 225

### blade swapping, 50

### blades

- compatibility, 44, 46
- disabling and enabling, 44
- enabling exceptions for the FR4-18i, 49
- port area ID, 41
- port identification, 41
- port indexing, 41
- port numbering schemes, 40
- powering off and on, 53
- types of, 39

### boot PROM password, 95

### bottleneck detection, 416

### Broadcast server, 4

### broadcast zones, 244

### Brocade Vendor-Specific Attribute, 101

### browser and Java support, 122

### browser, configuration for certificates, 125

### buffer credit management, 445

### buffer credit recovery, 453

### buffer-to-buffer credits, 67, 445

## C

### certificate authorities (CA), 123



- certificates
  - browser, configuring, 125
  - CSR, certificate signing request, 124
  - HTTPS, 118
  - installing, 125
  - obtaining, 125
  - private key, 124
  - public key, 124
  - root, 123
  - root, configuring, 126
  - security, 118
  - SSH, 118
  - SSL, 118, 122, 123, 151
  - switch, 123, 151
- changing
  - an account password, 91
  - FID of logical switch, 230
  - logical switch to base switch, 231
  - RADIUS configuration, 115
  - RADIUS servers, 115
- clearing performance monitor counters, 398
- clearing zone configurations, 258
- command line interface, 16
- configuration file
  - backing up, 178
  - chassis section, 178
  - configDownload, 180
  - configdownload in Admin Domain context, 362
  - configupload in Admin Domain context, 362
  - configUpload in interactive mode, 179
  - display settings, 175
  - format, 176
  - information not saved, 179
  - restoring, 180
  - restrictions on restoring, 180
  - save to a host, 175
  - switch section, 178
- configuring
  - access methods, Web Tools, 15
  - authentication, 99
  - browser certificates, 125
  - certificates, 122
  - changing RADIUS servers, 115
  - date and time, 25
  - Enforce LSAN tag, 483
  - FibreAlliance MIB, 127
  - for interconnectivity, 499
  - HTTPS access, 122
  - IAS, 107
  - interfabric link, 468
  - LINUX RADIUS server, 105
  - NTP, 28
  - private key, 124
  - public key, 124
  - RADIUS server, 105
  - RADIUS, changing, 115
  - root certificates, 126
  - security levels, 129
  - SNMP, 129
  - SNMP traps, 127
  - Speed LSAN tag, 484
  - SSL, 122, 123
  - switch, 113
  - switch, RADIUS client, 107
  - Windows RADIUS client, 107
  - zone, rules for, 243
- connecting
  - Fabric OS and M-EOS SANs, 497
  - multiple EX\_Ports to an edge fabric, 464
  - to devices, 33
- connection
  - restrictions, 87
  - serial, 17
  - telnet, 17
- core/edge topology and ISL trunking, 427
- CP blade, 376
  - access, 105
- creating
  - accounts, 88
  - Admin Domains, 345
  - alias, 246
  - base switches, 225
  - logical switches, 225
  - policy, 143
  - SCC policy, 143
  - TI zones, 282
  - zone configurations, 253, 254
  - zones, 249
- CSR (certificate signing request), 123, 124

customizing the switch name, 28

## D

date and time, 25

DCFM (Data Center Fabric Manager), 15

deactivating

Admin Domains, 349

TI zones, 285

default

IP Policy Rules, 156

logical switch, 210

zone mode, 252, 344

defined

AD configuration, 344

zone configuration, 242

deleting

accounts, 89

Admin Domains, 351, 352

alias, 248

end-to-end monitors, 388

frame monitors, 391

logical switches, 228

RADIUS configuration, 114

TI zones, 286

zone configurations, 256

zones, 250

detecting bottlenecks, 416

devices

proxy, 461

dictionary.brocade, 103

Directory server, 3

disabled zone configuration, 242

disabling, 43

bottleneck detection, 423

port, 43

RADIUS configuration, 114

Virtual Fabrics, 224

zone configurations, 256

displaying

Admin Domain configuration, 358

configuration settings, 175

logical switch configuration, 230

LSAN tags, 484

monitor counters, 397

RADIUS configuration, 115

TI zones, 286

trunking information, 429

Distributed Management Server

FCS policy, 5

management server database, 5

topology discovery, 9

well-known address, 4

Disturbed Management Server

well-known address, 5

domain ID

239 mode, 301

offset mode, 301

offset, default mode, 300

domain ID offset, 299

domain, phantom, 65

DPS (dynamic path selection), 74

dynamic PID binding, 35

## E

E\_Port, 11

edge-to-edge routing, 466

EFCM, 501, 503

effective AD configuration, 344

effective zone configuration, 242

enabling

bottleneck detection, 419

port, 43

Virtual Fabrics, 223

zone configurations, 255

enabling and disabling ISL trunking, 428

encryption using SSL, 122

end-to-end monitors

adding, 385

deleting, 388

restoring configuration, 399

saving configuration, 399

setting a mask, 387

end-to-end performance monitoring, 385

enforce LSAN tag, 481

equipment status, 54

events

date and time, 25

EX\_Port, 491, 501

EX\_Ports, 11

- extended fabrics
  - about, 441
  - buffer credit management, 445
  - buffer credit recovery, 453
  - buffer requirement calculation, 447
  - buffer-to-buffer credits, 445
  - device limitations, 442
  - extended ISLs, 443
  - F\_Port buffer credits, 450
  - ISL, 446
  - long-distance mode, 447
  - port buffer credit, 446
  - QoS buffer credit requirements, 453
  - time-division multiplexing, 444
- extended ISL, 216

## F

- F\_Port, 11
- fabric
  - parameters, 66
- fabric access, 131
- fabric addresses, 35
- fabric connectivity, 55
- Fabric controller, 3
- fabric interoperability
  - activating zones on stand-alone switch, 308
  - authentication
    - DH-CHAP, 312
    - Fabric OS switch settings, 313
    - license keys, 311
    - M-EOS switch settings, 313
    - policy for dumb switch, 316
    - switch modes, 312
    - switch policy, 313
  - effective zone configuration, 309
  - fabric binding, translate domains, 322
  - feature limitations, trunking, 329
  - mapping, mode values, 323
  - McDATA-aware features, 325
  - preferred domain ID, configuring, 323
  - SANtegrity
    - FCR, 322
    - preferred domain ID, 322
  - traffic isolation zones, 310
  - zone name restrictions, 307
  - zones, activating on stand-alone switch, 308
  - zoning restrictions, 307
- Fabric Login, 10
- Fabric Login server, 3

- Fabric OS
  - supported protocols, 117, 118
- Fabric Wide Consistency Policy, 466
- FC router, 143
- FC routing
  - concepts, 457
  - supported platforms, 456
- FC routing types, 461
- FCAP, 144
- FC-FC Routing, 143
- FC-FC Routing and Virtual Fabrics, 492
- FC-FC routing service, 455
- FCIP link, 498
- FCR and traffic isolation, 273
- FCS policy modifying, 137
- feature licenses, 365
- Fibre Channel NAT, 65
- Fibre Channel over IP, 467
- Fibre Channel protocol auto discovery process, 12
- Fibre Channel routing, 457
- Fibre Channel services, 3
- FICON-MIB, 128
- FIPS
  - certificates, installing, 526
  - firmwareDownload, 201
  - Inband Management, 509
  - LDAP certificates, displaying and deleting, 526
- firmware download, 190
  - auto-leveling, 205
  - connected switches, 192
  - enterprise-class platforms, 196
  - FICUN CUP considerations, 191
  - FIPS, 201
  - high availability synchronization, 191
  - obtaining firmware, 193
  - process overview, 194
  - protocol, FTP and SCP, 189
  - switches, 193
  - test and restore on enterprise-class platforms, 204
  - test and restore on switches, 203
  - testing different firmware versions, 205
  - USB device, 200
  - validating, 207
  - verify progress, 190
- FL\_Port, 11
- FLOGI, 12

- frame monitors
  - deleting, 391
  - restoring configuration, 399
  - saving, 391
  - saving configuration, 399
- frame redirection, 81
- FreeRADIUS, 105

## G

- G\_Port, 11
- gateway links
  - buffer credits, 441

## H

- HA failover, 91, 105
- high availability (HA), 54
- home Admin Domain, 104, 340
- host-based zoning, 239
- HTTPS, 122
  - certificates, security, 118

## I

- IAS
  - configuring, 107
  - remote access policies, 108
- ICLs
  - about Inter-Chassis Links, 71
  - LEDs, 72
  - triangular topology, 72
- IFL
  - about, 458
  - configuring, 468
- implementing Admin Domains, 344
- Inband Management
  - FIPS, 509
  - internal Ethernet devices, 506
  - IP addresses, 506, 507
  - IP routes, 508
  - routing, 506
  - SNMP polling, 505
- ingress rate limiting, 402
- initializing trunking on ports, 428

- installing
  - certificates, 125
  - certificates for FIPS, 526
- installing a root certificate to the Java plug-in, 126
- Integrated Routing, 457
- interfabric link, *see* IFL
- Internet Explorer and SSL support, 122
- interswitch link, 33
- inter-switch link (ISL), 66
- IP Filter
  - supported services, 155
- IP-NAT, 65
- IPsec
  - algorithms, 167
  - Authentication Header protocol, 166
  - configuration on the management interface, 164
  - Encapsulating Security Payload protocol, 166
  - flushing SAs, 173
  - IKE policies, 169
  - key management, 169
  - manual key entry, 170
  - policies, 168
  - pre-shared key, 169
  - sa-proposal, 167
  - security association, 167
  - security certificate, 169
  - traffic selector, 168
  - transform set, 168
- ISL, 33

## J

- Java support, SSL, 122
- Java version, 122

## L

- license ID, 375
- licensed features, 365
- licenses
  - Extended Fabrics, 441
  - license ID, 375
  - overview, 365
  - purchasing keys, 378
  - remove feature, 377
- limiting traffic from a device, 403
- Linux, configuring RADIUS on, 105
- LISL, 217

- local authentication
  - overview, 115
- local clock, 28
- LOCL, 28
- logging timestamp, 25
- logical fabrics
  - about, 214
  - changing context, 233
- logical ISLs, 217
- logical ports, 218
- logical switches
  - about, 210
  - allowing XISL use, 232
  - changing FID, 230
  - changing to a base switch, 231
  - creating, 225
  - deleting, 228
  - displaying configuration, 230
  - moving ports, 229
- login
  - changing password, 89
  - fails, 17
  - with Admin Domains, 340
- login sessions, maximum allowed, 87
- lossless dynamic load sharing, 79
- LSAN, 477
- LSAN tags, 481
- LSAN zone binding, 485
- LSAN zones
  - in Admin Domains, 362
- LUN sharing, 498

## M

- M\_Port, 11
- making basic connections, 33
- Management server, 4
- managing
  - accounts, 89
  - zoning configurations in a fabric, 259
- mask for end-to-end monitors
  - setting, 387
- matching fabric parameters, 464
- McDATA, 501
- members
  - policy, 134
- M-EOS SANs, connecting with Fabric OS SANs, 497
- merging zones, 253
- MIB, 127

- modifying
  - TI zones, 284
  - zoning configurations, 253
- modifying the FCS policy, 137
- monitoring
  - end-to-end performance, 385
  - ISL performance, 393
  - trunks, 397
- monitors
  - clearing counters, 398
- Mozilla Firefox and SSL support, 122

## N

- NAT, 65
- network address translation, see NAT
- network security, 119
- NPIV
  - 10-bit addressing mode, 292
  - configuring, 293
  - disabling, 294
  - enabling, 294
  - viewing PID login information, 296
- NTP access, 28

## P

- password, 18
  - boot PROM, 95
  - changing, 89
  - changing defaults, 19
  - default, 19
  - limits, 19
  - recovery string, 97
  - recovery string, boot PROM password, 95
  - rules, 89
- password expiration policy, 93
- password policies, 90
- password policy
  - account lockout, 93
- password strength policy, 91
- permissions and roles, 85
- phantom domains, 460, 462
- physical fabric administrator, 338
- PID
  - 10-bit addressing mode, 36
  - swapping port area IDs, 42
- PKI (public key infrastructure), 122

platforms, FC routing supported, 456

PLOGI, 12

POD

- activating, 379

- enabling ports, 43

policies, routing, 63

policy

- creating, 143

- creating, SCC, 143

- members, identifying, 134

- password expiration, 93

- password strength, 91

- SCC, 143

port, 43

- activating POD, 379

- enabling, 43

Port Login, 10

port mirroring, 11

port type

- E\_Port, 11

- EX\_Port, 11

- F\_Port, 11

- FL\_Port, 11

- G\_Port, 11

- M\_Port, 11

- U\_Port, 11

- VE\_Port, 11

- VEX\_Port, 11

primary FCS, 5

Principal ISLs, 64

priority groups, 67

private key, 124

PRLI, 12

protocols

- secure, 117, 118

proxy

- devices, 461

proxy PID, 459, 489

public key, 124

public key infrastructure encryption, 122

## Q

QoS, 403

- buffer credit requirement, 453

QoS over FC routers, 408

QoS zones, 406

## R

RADIUS, 114, 115

- ADList, 104

- ContextRoleList, 104

- homeAD, 104

- Virtual Fabrics HomeContext, 104

RADIUS client

- Windows configuration, 107

RADIUS clients

- switch configuration, 107

RADIUS server, 102

- configuration, 105

- LINUX configuration, 105

RADIUS service

- Windows configuration, 107

RBAC, 84

Registered State Change Notification, 12

remote access policies, 108

remove feature, 377

removing

- Admin Domain members, 350

- Admin Domains from user accounts, 348

- alias members, 247

- frame monitors, 391

- licensed feature, 377

- LSAN tags, 484

- members from a zone configuration, 255

- ports from logical switches, 229

- zone configurations, 255

- zone members, 250

renaming Admin Domains, 350

requirements

- Admin Domains, 337

restoring monitor configuration, 399

Role-Based Action Control. See RBAC.

routing

- dynamic load sharing, 76

- exchange-based, 74, 78

- frame order delivery, 78

- frame redirection, 81

- lossless dynamic load sharing, 79

- out-of-order exchanges, 78

- port-based, 73, 74, 78

- static routes, 77

- Virtual Fabrics, 75

routing policies, 63, 74

RSCN, 30

## rules

- configuring zones, for, 243
- password, 89

## S

SAN Pilot, 501

saved zone configuration, 242

saving monitor configuration, 399

scalability, 499

SCC policy, 143

secure shell (ssh), 119

secure sockets layer, 122

### security

- AUTH policy, 144

- Brocade MIB, 127

- browsers, 122

- certificates, 118

- encryption and SSL, 122

- FibreAlliance MIB, 127

- HTTPS, certificate, 118

- IAS remote access policies, 108

- IP policy rules, 156

- obtaining certificates, 125

- policies, ACL, 133

- secure protocols, supported, 117, 118

- setting levels, 129

- SNMP traps, 127

- SSH certificate, 118

- SSL certificate, 118

security and zoning, 263

serial connection, 16, 17

sessions, maximum allowed, 87

### setting

- changing passwords, 19

- default zone mode, 344

- mask for end-to-end monitors, 387

- password, boot PROM, 95

- security level, 129

- switch date and time, 25

- the IP address, 22

- time zone, 27

- time zones, 26, 27

- traffic prioritization, 414

- traffic prioritization over FC routers, 415

setting chassis configurations, 44

SID/DID traffic prioritization, 403

## SNMP, 127

- ACL, 127

- agent, 127

- attributes, 129

- configuration changes, 129

- configuring, 129

- password change, 89

- polling, 505

- traps, 505

- v1, 127

- v3, 127

specifying frame order delivery, 78

Speed LSA tag, 482

SSH certificates, 118

SSL, 122, 123, 151

SSL certificates, security, 118

standby CP blade, 105

State Change Registration, 10

static PIDs, NPIV, 38

static route, 77

storage-based zoning, 239

### support

- FC router, 143

- Java version, 122

- SNMPv3 and v1, 127

SW-EXTTRAP, 128

### switch

- access methods, Web Tools, 15

- certificates, installing, 125

- certificates, installing for FIPS, 526

- configuring, 113

- deleting RADIUS configuration, 114

- disabling port, 43

- displaying RADIUS configuration, 115

- name limitations, 30

- RADIUS client, 107

- RADIUS configuration, disabling, 114

- user-defined accounts, 88

switch access, 131

switch firmware version, finding, 193

switch names, 30

switch WWN in Admin Domains, 342

system-defined Admin Domains, 338

## T

tags for LSA zones, 481

telnet connection, 17

- TI zones, 267
  - activating, 285
  - changing state, 285
  - creating, 282
  - creating in a base fabric, 284
  - deactivating, 285
  - deleting, 286
  - displaying, 286
  - modifying, 284
  - with Virtual Fabrics, 281
- time and date, 25
- time zones, 25
- Top Talkers, 393, 401
- tracking and controlling switch changes, 56
- traffic isolation over FCR, 273
- traffic isolation over FCR with Virtual Fabrics, 281
- traffic patterns
  - planning for, 427
- traffic prioritization, 403
- transaction model
  - managing Admin Domains, 344
- traps
  - MIB, 127
  - SNMP, 127
- trunking
  - with TI zones, 278

## U

- U\_Port, 11
- USB device, 200
- user accounts and removing Admin Domains, 348
- user databases, 90
- user-defined
  - accounts, 88
  - Admin Domains, 338
- users
  - assigning to Admin Domains, 346
  - authenticating, 84
- using security certificates, 122

## V

- validating Admin Domain members, 356
- VE\_Port, 11
- verification check, 464

- verify
  - device connectivity, 33
  - high availability (HA), 54
- VEX\_Port, 11
- VF mode
  - definition, 223
  - See also Virtual Fabrics, 223
- viewing
  - alias, 248
  - zones, 251
- virtual channels, 67
- Virtual Fabrics
  - and FC-FC Routing, 492
  - and ingress rate limiting, 403
  - base switches, about, 216
  - base switches, creating, 225
  - ContextRoleList, 104
  - date settings, 25
  - default logical switch, 210
  - disabling, 224
  - enabling, 223
  - extended ISL (XISL), 216
  - F\_Port trunking, 432
  - FID, changing, 230
  - HomeContext, 104
  - logical fabric context change, 233
  - logical fabrics, about, 214
  - logical ISLs (LISL), 217
  - logical switch configuration, displaying, 230
  - logical switch to base switch change, 231
  - logical switches, about, 210
  - logical switches, creating, 225
  - logical switches, deleting, 228
  - overview, 209
  - platform services, 5
  - ports, moving, 229
  - restrictions, 222
  - supported platforms, 220
  - with traffic isolation over FCR, 281
  - XISL, allowing on logical switches, 232
- VSA, 101

## W

- Web Tools access methods, configuration, 15
- well-known addresses, 3
- Windows RADIUS, configuring, 107
- working with domain IDs, 28
- WWN, 376
  - format for logical ports, 218



WWN-based PID assignment, 37  
WWNs  
    switch WWNs in Admin Domains, 342

## X

XISL, about, 216  
xlate domains, 462

## Z

zone  
    adding a new switch or fabric, 261  
    adding members, 249  
    administering security, 263  
    alias, adding members, 247  
    alias, deleting, 248  
    alias, removing members, 247  
    alias, viewing, 248  
    aliases, 241  
    aliases, creating and managing, 246  
    all access, 252  
    concepts, 238  
    configurations, 242  
    configurations, adding members, 254  
    configurations, creating and maintaining, 253  
    configurations, managing, 259  
    configuring rules, 243  
    creating, 249  
    creating a configuration, 254  
    database configurations, viewing, 258  
    database size, 253  
    default zone mode, 252, 344  
    defined zone configuration, 242  
    deleting, 250  
    deleting a configuration, 256  
    disabled zone configuration, 242  
    disabling a configuration, 256  
    effective zone configuration, 242  
    enabling a configuration, 255  
    enforcement, 242  
    host-based, 239  
    LUN masking, 239  
    merging, 253  
    name server-based, 239  
    no access, 252  
    objects, 240  
    optimizing resources, 238  
    removing members, 250  
    removing members from a configuration, 255  
    saved zone configuration, 242  
    schemes, 241  
    soft-zoning, 239  
    splitting a fabric, 263  
    storage-based, 239  
    terminology, 238  
    types, 239  
    viewing, 251  
    viewing configurations, 258  
zone configuration  
    clearing, 258

- zone configurations
  - creating, 254
  - deleting, 256
  - disabling, 256
  - enabling, 255
  - removing, 255
- zone database and Admin Domains, 360
- zone, broadcast, 244
- zones
  - QoS zones, 406
  - TI zones, 267